

# CABLE SOLUTIONS FOR ELECTRONIC WIRE & CABLE

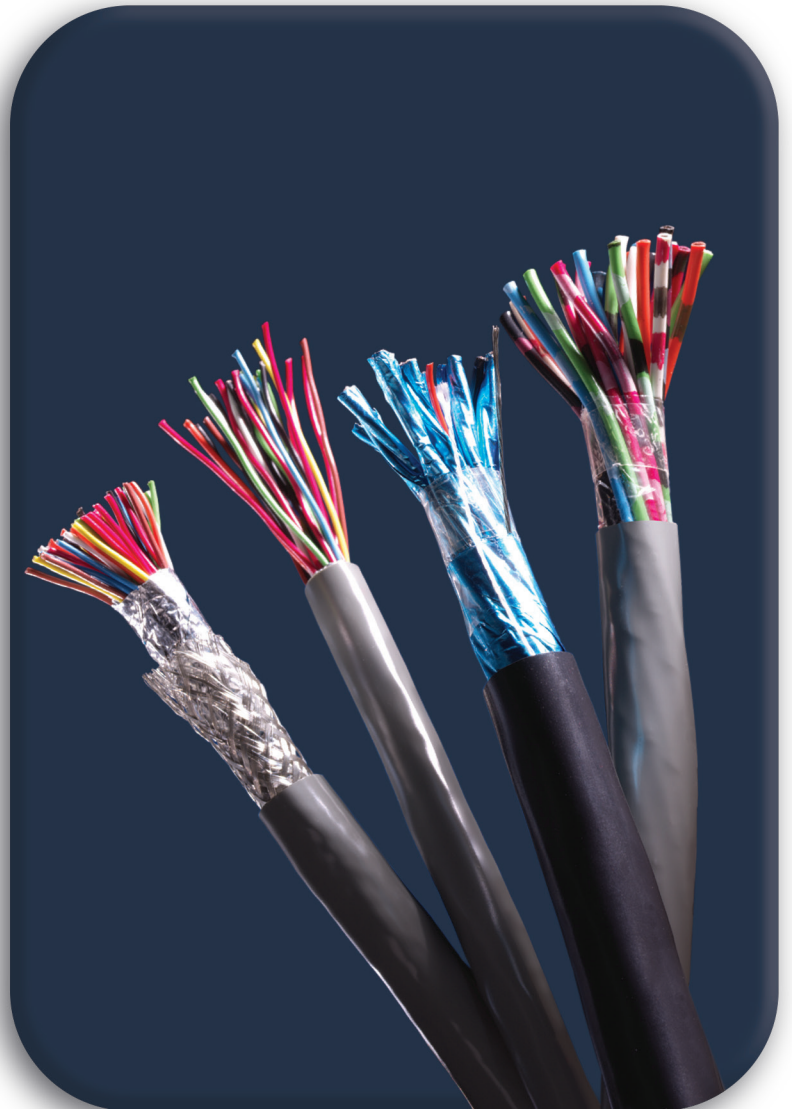

# Electronic Wire & Cable

This catalog contains in-depth information on the most comprehensive line of copper Electronics products available today for data transmission, sound, security/fire alarm, professional audio and video broadcast.

In a rapidly changing industry with ever-growing demands, Prysmian Group continues to stay ahead of the curve with engineered products that guarantee future performance. Choose from the best cable in its class—CAROL® Brand.

Our products are readily available for immediate shipment through our network of authorized stocking distributors and distribution centers.



All information in this catalog is presented solely as a guide to product selection and is believed to be reliable. All printing errors are subject to correction in subsequent releases of this catalog. Although Prysmian has taken precautions to ensure the accuracy of the product specifications at the time of publication, the specifications of all products contained herein are subject to change without notice.

PRYSMIAN, CAROL, CAROLGRENE, COMMAND SERIES, DEMAND BETTER...EXPECT MORE, FLEXFOIL, LO-CAP, MOISTURE GUARD, ONE COMPANY CONNECTING THE WORLD, PULL-PAC, SMARTWRAP, SPOOL-PAC, SUPERFLEX, WIRE WIZARD and logos are trademarks of Prysmian North America.

© 2024. Prysmian North America.  
Highland Heights, KY 41076  
All rights reserved. Printed in USA.

# Demand Better... Expect More™

## FROM CAROL® BRAND

### QUALITY



Prysmian is committed to meeting customer requirements through continuous quality improvements. As a significant part of our commitment to quality, Prysmian's manufacturing facilities are certified to the ISO 9001:2015 quality standard. Our telecommunications cable manufacturing facility has received TL 9000 quality standards registration

as a supplement to the ISO program. This quality system is based on the ISO 9001 program with added telecommunications-specific performance metrics. We strive to provide value optimization through innovation and quality solutions.

- Our in-house testing capabilities are extensive, with strict adherence to our product specifications as well as industry standards.
- Cables are safety listed and verified.
- Third-party testing labs like ETL and UL are utilized to quantify and confirm our quality and provide final qualification data that sets the foundation for our extended product warranty.
- Prysmian products have stood the test of time with proven reliability and performance.

### CUSTOMER SERVICE



Prysmian is dedicated to customer service and satisfaction. Call our team of professionally trained sales associates at

# 888-295-5896

with any questions to meet your application needs.

[na.prysmian.com](http://na.prysmian.com)

# Table of Contents

## SECTION

## PAGES

<b>1</b>	<b>COMMUNICATION &amp; CONTROL CABLE, MULTI-CONDUCTOR</b>	<b>1-31</b>
•	Multi-Conductor, Unshielded.....	2-13
•	Power-Limited Tray Cable, Unshielded.....	14
•	Multi-Conductor, Foil Shield.....	15-18
•	Multi-Conductor, Foil Shield (CSA).....	19-22
•	Power-Limited Tray Cable, Foil Shield.....	23
•	Multi-Conductor, Spiral Shield.....	24
•	Multi-Conductor, Braid Shield.....	25-27
•	Multi-Conductor, Foil/Braid Shield.....	28
•	Multi-Conductor, Rubber, Unshielded.....	29
•	Multi-Conductor, Rubber, Braid Shield.....	30
•	Multi-Conductor, Carolprene®, Braid Shield.....	31
<b>2</b>	<b>COMMUNICATION &amp; CONTROL CABLE, MULTI-PAIRED</b>	<b>33-45</b>
•	Multi-Paired, Unshielded.....	34-35
•	Multi-Paired, Foil Shield.....	36-39
•	Multi-Paired, Individually Shielded (UL).....	40
•	Multi-Paired, Individually Shielded (CSA).....	41
•	Power-Limited Tray Cable, Individually Shielded.....	42
•	Power-Limited Tray Cable, Foil Shield.....	43
<b>3</b>	<b>COMPUTER CABLE</b>	<b>44-58</b>
•	Multi-Conductor, Foil Shield.....	45-46
•	Multi-Conductor, Foil/Braid Shield.....	47-48
•	Multi-Conductor, Foil/Braid Shield, Lo-Cap.....	49
•	Multi-Paired, Foil Shield.....	50
•	Multi-Paired, Foil Shield, Lo-Cap.....	51
•	Multi-Paired, Foil/Braid Shield.....	52
•	Multi-Paired, Foil/Braid Shield, Lo-Cap.....	53-55
•	Multi-Paired, Individually Foil Shielded.....	56
•	Multi-Paired, Individually Foil Shielded, Lo-Cap.....	57
•	Multi-Paired, Individually Foil/Braid Shielded, Lo-Cap.....	58

# Table of Contents

## SECTION

## PAGES

<b>4</b>	<b>EXZEL® HIGH-ENDURANCE CABLES</b>	<b>59-79</b>
•	CAROL® Brand Exzel® For Complete Peace of Mind.....	60-62
•	Multi-Conductor, Unshielded.....	63
•	Multi-Conductor, Foil Shielded.....	64
•	Multi-Conductor, Foil/Braid Shielded.....	65
•	Multi-Paired, Unshielded.....	66
•	Multi-Paired, Foil Shielded.....	67
•	Multi-Paired, Foil/Braid Shielded.....	68
•	Multi-Conductor, Unshielded, Heavy Duty.....	69
•	Multi-Conductor, Foil Shielded, Heavy Duty.....	70
•	Multi-Conductor, Foil/Braid Shielded, Heavy Duty.....	71
•	Multi-Paired, Foil/Braid Shielded, Heavy Duty.....	72
•	LSZH Multi-Conductor, Unshielded.....	73
•	LSZH Multi-Conductor, Foil Shielded.....	74
•	LSZH Multi-Conductor, Foil/Braid Shielded.....	75
•	LSZH Multi-Paired, Unshielded.....	76
•	LSZH Multi-Paired, Foil Shielded.....	77
•	LSZH Multi-Paired, Foil/Braid Shielded.....	78
•	Color Code Charts.....	79
<b>5</b>	<b>FIRE ALARM CABLES</b>	<b>80-94</b>
•	Multi-Conductor, Unshielded, Non-Plenum.....	81
•	Multi-Conductor, Unshielded, Non-Plenum (CSA).....	82
•	Multi-Conductor, Shielded, Non-Plenum.....	83
•	Multi-Conductor, Shielded, Non-Plenum (CSA).....	84
•	Multi-Conductor, Unshielded, Plenum.....	85-86
•	Multi-Conductor, Shielded, Plenum.....	87-88
•	Multi-Conductor, Unshielded, Plenum.....	89
•	Multi-Conductor, Shielded, Riser.....	90
•	Mid-Capacitance, Unshielded, Riser.....	91
•	Mid-Capacitance, Shielded, Non-Plenum.....	92
•	Mid-Capacitance, Unshielded, Plenum.....	93
•	Mid-Capacitance, Shielded, Plenum.....	94

# Table of Contents

## SECTION

## PAGES

<b>6</b>	<b>SOUND, ALARM &amp; SECURITY CABLE</b>	<b>95-105</b>
	• Composite Access Control Cable, Plenum .....	96
	• Composite Access Control Cable, Riser .....	97
	• Multi-Conductor, Unshielded, Riser .....	98
	• Multi-Conductor, Shielded, Riser .....	99
	• Multi-Conductor, Unshielded, Plenum .....	100
	• Multi-Conductor, Shielded, Plenum .....	101
	• Telephone Station/Intercom & Speaker/Burglar Alarm .....	102
	• Thermostat Wire Type LVT .....	103
	• Thermostat Wire Type CL2 .....	104
	• Thermostat Wire, Unjacketed .....	105
<b>7</b>	<b>CATEGORY CABLES</b>	<b>106-110</b>
	• Category 6A Cable .....	107-108
	• Category 6 Cable .....	109
	• Category 5e Cable .....	110
<b>8</b>	<b>COAXIAL CABLE</b>	<b>111-130</b>
	• RG 6/U Type .....	112-116
	• RG 8/U Type .....	117
	• RG 11/U Type .....	118-120
	• RG 58/U Type .....	121
	• RG 59/U Type .....	122-126
	• RG 62/U Type .....	127
	• RG 174/U Type .....	128
	• RG 213/U Type .....	129
	• Twinaxial Cables .....	130
<b>9</b>	<b>SPECIALTY CABLE</b>	<b>131-141</b>
	• Multi-Conductor, Flexfoil Shield® .....	132
	• Speaker Wire .....	133
	• Command® Series Home Entertainment Speaker Cable .....	134
	• CAROL® Brand DMX Lighting Control Cable .....	135
	• Special Audio, Communication & Instrumentation .....	136-137
	• Microphone Cable, Multi-Conductor, Carolprene® .....	138
	• Irrigation and Landscape Lighting .....	139-140
	• Low-Voltage Sprinkler Wire .....	141

# Table of Contents

## SECTION

## PAGES

<b>10</b>	<b>HOOK-UP WIRE</b>	<b>142-148</b>
•	UL 1007, UL 1569, CSA TR-64 .....	143
•	UL 1015, CSA TEW .....	144
•	UL Types MTW, TFF, AWM & CSA TEW .....	145
•	Heavy Wall UL Types MTW, AWM, NEC Type THW and CSA TEW .....	146
•	Rubber/PVC/Polyethylene.....	147
<b>11</b>	<b>TECHNICAL INFORMATION</b>	<b>149-182</b>
•	Insulation & Jacket Properties.....	150
•	Decimal Conversion Factors.....	151
•	Unit Conversion Factors.....	152
•	Temperature Conversion Chart.....	153
•	Conduit Capacity Chart.....	154
•	AWG Conductor Chart.....	155
•	Glossary.....	156-166
•	Abbreviations & Acronyms.....	167-169
•	Product Finder—Hook-Up Wire.....	170
•	Product Finder—Multi-Conductor Cable.....	171-176
•	Belden to CAROL® Brand Cross Reference Index .....	177-178
•	NEC/CEC Substitution Chart.....	179-180
•	Agency Symbols.....	181
•	Put-Ups and Color Codes.....	182
<b>12</b>	<b>AGENCY APPROVAL INDEX</b>	<b>183-184</b>
•	Agency Approval Index.....	183

# Communication & Control Cable, Multi-Conductor 1

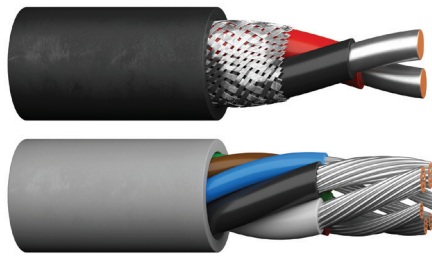

The multi-conductor array of communication and control cable facilitates cable pull-ins and single-site installations.

This cable is typically used for industrial equipment control, electric valve actuation and remote signaling, as well as communications and broadcast applications. These designs are available in a wide variety of insulation and jacketing materials, as well as shield designs to alleviate unwanted circuit noise.

Prysmian’s CAROL® Brand products are manufactured to meet the latest UL, CSA and NEC requirements and approvals.

### *A Design To Meet Every Application*

PVC/PVC designs employ polyvinyl chloride insulations and jackets capable of meeting everyday, general purpose applications.

PE or PP/PVC designs employ high quality polyethylene or polypropylene insulations to assure faithful reproduction of transmitted signals across interconnection circuits.

Foamed PP/PVC designs use high speed, foamed polypropylene insulations for long-distance critical circuits, which would not perform if higher loss insulations were employed.

FEP/FEP designs employ fluoropolymer 200°C-rated materials. They are recommended for use in applications where high temperature, plenum rating, electrical and mechanical safety and chemical resistance are essential.

Rubber/Rubber is typically employed in installations characterized as severely hostile environments, where these designs provide unsurpassed service life.

Rubber/Carolprene® offers the ultimate performance for applications that demand the greatest protection from the environment, including physical abuse. The specially formulated Carolprene® jacket has been proven time and again to withstand all types of abuse, both mechanical and chemical.

Section	Page
Multi-Conductor, Unshielded	2-14
Power-Limited Tray Cable, Unshielded	15
Multi-Conductor, Foil Shield	16-20
Multi-Conductor, Foil Shield (CSA)	21-24
Power-Limited Tray Cable, Foil Shield	25
Multi-Conductor, Spiral Shield	26
Multi-Conductor, Braid Shield	27-29
Multi-Conductor, Foil/Braid Shield	30
Multi-Conductor, Foil & TC Braid Shield	31
Multi-Conductor, Rubber, Unshielded	32
Multi-Conductor, Rubber, Braid Shield	33
Multi-Conductor, Carolprene, Braid Shield	34

# Multi-Conductor, Unshielded

UL 2464, NEC/CEC Type CMG UL/CSA\*\*

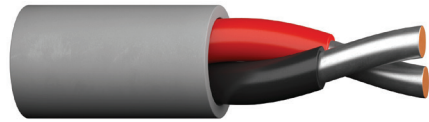

CATALOG NUMBER	NO. OF COND.	AWG SIZE	COND. STRAND	NOM. INSULATION THICKNESS		NOM. JACKET THICKNESS		NOMINAL O.D.		COLOR CODE	NOM. C-C CAP.* pF/ft
				in	mm	in	mm	in	mm		
<b>C4311A</b>	2	20	Solid	0.010	0.25	0.032	0.81	0.166	4.22	Black/Red	28.0

\*Capacitance between conductors

\*\*CSA or c(UL)

Data subject to change.

**Product Construction:**

**Conductor:**

- Fully annealed tinned copper per ASTM B33 (C4311A)

**Insulation:**

- Premium-grade, color-coded PVC

**Jacket:**

- PVC, gray
- Temperature range: -20°C to +105°C

**Applications:**

- Public address systems
- Intercoms
- Remote control circuits
- Suggested voltage rating: 300 volts

**Compliances:**

- NEC Article 800 Type CM (UL: 105°C)
- UL Style 2464 (UL: 80°C, 300 V)
- CSA CMG (CSA: 105°C)
- RoHS Compliant Directive 2015/863/EU (RoHS-3)
- Passes CSA CMG Flame Test
- Sunlight Resistant

**Packaging:**

- Please contact Customer Service for packaging and color options





# Multi-Conductor, Unshielded

UL 2464, NEC/CEC Type CMG UL/CSA\*\*

**Product Construction:**

**Conductor:**

- 22 thru 18 fully annealed stranded tinned copper per ASTM B33

**Insulation:**

- Premium-grade, color-coded PVC
- Color code: See chart below

**Jacket:**

- PVC, gray
- Temperature range: -20°C to +105°C

**Applications:**

- TV antenna rotor control
- Satellite actuator control
- Public address systems
- Suggested voltage rating: 300 volts

**Compliances:**

- NEC Article 800 Type CM (UL: 105°C)
- UL Style 2464 (UL: 80°C, 300 V)
- CSA CMG (CSA: 105°C)
- RoHS Compliant Directive 2015/863/EU (RoHS-3)
- Passes CSA CMG Flame Test
- Sunlight Resistant

**Packaging:**

- Please contact Customer Service for packaging and color options

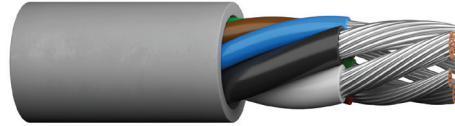

CATALOG NUMBER	NO. OF COND.	AWG SIZE	COND. STRAND	NOM. INSULATION THICKNESS		NOM. JACKET THICKNESS		NOMINAL O.D.		NOM. C-C CAP.* pF/ft
				in	mm	in	mm	in	mm	
<b>C4081A</b>	6	4-22 2-18	7/30 16/30	0.010 0.016	0.25 0.41	0.032	0.81	0.244	6.20	24.5 31.0
<b>C4082A</b>	7	5-22 2-18	7/30 16/30	0.010 0.016	0.25 0.41	0.032	0.81	0.253	6.43	24.5 31.0
<b>C4083A</b>	8	6-22 2-18	7/30 16/30	0.010 0.016	0.25 0.41	0.032	0.81	0.263	6.69	24.5 31.0
<b>C4084A</b>	9	7-22 2-18	7/30 16/30	0.010 0.016	0.25 0.41	0.032	0.81	0.273	6.94	24.5 31.0

\*Capacitance between conductors

\*\*CSA or c(UL)

Data subject to change.

**COLOR CODE CHART**

NO. OF COND.	COLOR
<b>1 18 ga.</b>	Black
<b>2</b>	White
<b>1 22 ga.</b>	Red
<b>2</b>	Green
<b>3</b>	Brown
<b>4</b>	Blue
<b>5</b>	Orange
<b>6</b>	Yellow
<b>7</b>	Purple



# Multi-Conductor, Unshielded

UL 2464, UL 2576, NEC/CEC Type CMG UL/CSA\*\*

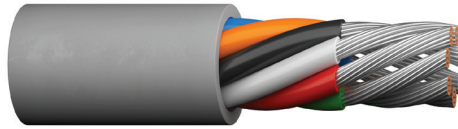

CATALOG NUMBER	NO. OF COND.	AWG SIZE	COND. STRAND	NOM. INSULATION THICKNESS		NOM. JACKET THICKNESS		NOMINAL O.D.		COLOR CODE	NOM. C-C CAP.* pF/ft
				in	mm	in	mm	in	mm		
<b>C2461A</b>	2	24	7/32	0.010	0.25	0.032	0.81	0.152	3.86	Black/Red	23.0
<b>C2462A</b>	3	24	7/32	0.010	0.25	0.032	0.81	0.163	4.14	Black/Red/Green	23.0
<b>C2463A</b>	4	24	7/32	0.010	0.25	0.032	0.81	0.174	4.42	1	23.0
<b>C2464A</b>	5	24	7/32	0.010	0.25	0.032	0.81	0.183	4.75	1	23.0
<b>C2466A</b>	6	24	7/32	0.010	0.25	0.032	0.81	0.200	5.08	1	23.0
<b>C2488A</b>	7	24	7/32	0.010	0.25	0.032	0.81	0.200	5.08	1	23.0
<b>C2465A</b>	8	24	7/32	0.010	0.25	0.032	0.81	0.214	5.44	1	23.0
<b>C2470A</b>	9	24	7/32	0.010	0.25	0.032	0.81	0.227	5.77	1	23.0
<b>C2471A</b>	10	24	7/32	0.010	0.25	0.032	0.81	0.244	6.20	1	23.0
<b>C2467A</b>	12	24	7/32	0.010	0.25	0.032	0.81	0.251	6.38	1	23.0
<b>C2473A</b>	15	24	7/32	0.010	0.25	0.032	0.81	0.275	6.99	2	23.0

\*Capacitance between conductors

\*\*CSA or c(UL)

Data subject to change.

**Product Construction:**

**Conductor:**

- 24 AWG fully annealed stranded tinned copper per ASTM B33

**Insulation:**

- Premium-grade, color-coded PVC
- Color code: See charts below

**Jacket:**

- PVC, gray
- Temperature range: -20°C to +105°C

**Applications:**

- Public address systems
- Intercoms
- Internal telephones
- Remote control circuits
- Suitable for EIA RS-232 applications
- Suggested voltage rating: 300 volts

**Compliances:**

- NEC Article 800 Type CM (UL: 105°C)
- UL Style 2464 (UL: 80°C, 300 V)
- UL Style 2576 (UL: 80°C, 150 V)
- CSA CMG (CSA: 105°C)
- RoHS Compliant Directive 2015/863/EU (RoHS-3)
- Passes CSA CMG Flame Test
- Sunlight Resistant

**Packaging:**

- Please contact Customer Service for packaging and color options

**COLOR CODE CHART 1**

For cables up to and including 12 conductors

NO. OF COND.	COLOR	NO. OF COND.	COLOR	NO. OF COND.	COLOR	NO. OF COND.	COLOR
<b>1</b>	Black	<b>4</b>	Green	<b>7</b>	Orange	<b>10</b>	Gray
<b>2</b>	White	<b>5</b>	Brown	<b>8</b>	Yellow	<b>11</b>	Pink
<b>3</b>	Red	<b>6</b>	Blue	<b>9</b>	Purple	<b>12</b>	Tan

**COLOR CODE CHART 2 PER ICEA**

For cables with 15 conductors

NO. OF COND.	COLOR	NO. OF COND.	COLOR	NO. OF COND.	COLOR
<b>1</b>	Black	<b>6</b>	Blue	<b>11</b>	Blue/Black
<b>2</b>	White	<b>7</b>	White/Black	<b>12</b>	Black/White
<b>3</b>	Red	<b>8</b>	Red/Black	<b>13</b>	Red/White
<b>4</b>	Green	<b>9</b>	Green/Black	<b>14</b>	Green/White
<b>5</b>	Orange	<b>10</b>	Orange/Black	<b>15</b>	Blue/White



# Multi-Conductor, Unshielded

UL 2464, UL 2576, NEC/CEC Type CMG UL/CSA\*\*

### Product Construction:

#### Conductor:

- 22 AWG fully annealed, stranded tinned copper per ASTM B33

#### Insulation:

- Premium-grade, color-coded PVC
- Color code: See charts below

#### Jacket:

- PVC, gray
- Temperature range: -20°C to +105°C

### Applications:

- Public address systems
- Intercoms
- Internal telephones
- Remote control circuits
- Suitable for EIA RS-232 applications
- Suggested voltage rating: 300 volts

### Compliances:

- NEC Article 800 Type CM (UL: 105°C)
- UL Style 2464 (UL: 80°C, 300 V)
- UL Style 2576 (UL: 80°C, 150 V)
- CSA CMG (CSA 105°C)
- RoHS Compliant Directive 2015/863/EU (RoHS-3)
- Passes CSA CMG Flame Test
- Sunlight Resistant

### Packaging:

- Please contact Customer Service for packaging and color options

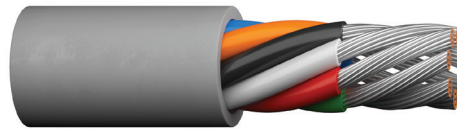

CATALOG NUMBER	NO. OF COND.	AWG SIZE	COND. STRAND	NOM. INSULATION THICKNESS		NOM. JACKET THICKNESS		NOMINAL O.D.		COLOR CODE	NOM. C-C CAP.* pF/ft
				in	mm	in	mm	in	mm		
<b>C6348A†</b>	2	22	7/30	0.010	0.25	0.015	0.38	0.130	3.30	Black/Red	24.5
<b>C4062A</b>	3	22	7/30	0.010	0.25	0.032	0.81	0.176	4.47	Black/Red/Green	24.5
<b>C4063A</b>	4	22	7/30	0.010	0.25	0.032	0.81	0.182	4.80	1	24.5
<b>C4064A</b>	5	22	7/30	0.010	0.25	0.032	0.81	0.203	5.16	1	24.5
<b>C4066A</b>	6	22	7/30	0.010	0.25	0.032	0.81	0.218	5.54	1	24.5
<b>C4088A</b>	7	22	7/30	0.010	0.25	0.032	0.81	0.205	5.54	1	24.5
<b>C4065A</b>	8	22	7/30	0.010	0.25	0.032	0.81	0.230	5.94	1	24.5
<b>C4070A</b>	9	22	7/30	0.010	0.25	0.032	0.81	0.249	6.32	1	24.5
<b>C4071A</b>	10	22	7/30	0.010	0.25	0.032	0.81	0.268	6.81	1	24.5
<b>C4067A</b>	12	22	7/30	0.010	0.25	0.032	0.81	0.276	7.01	1	24.5
<b>C4073A</b>	15	22	7/30	0.010	0.25	0.032	0.81	0.303	7.70	2	24.5
<b>C4075A</b>	20	22	7/30	0.010	0.25	0.032	0.81	0.334	8.48	2	24.5
<b>C4076A</b>	25	22	7/30	0.010	0.25	0.032	0.81	0.368	9.35	2	24.5
<b>C4077A</b>	30	22	7/30	0.010	0.25	0.032	0.81	0.389	9.88	2	24.5
<b>C4078A</b>	40	22	7/30	0.010	0.25	0.032	0.81	0.434	11.02	2	24.5
<b>C4079A</b>	50	22	7/30	0.010	0.25	0.032	0.81	0.489	12.42	2	24.5

\*Capacitance between conductors

\*\*CSA or c(UL)

†CM-CSA CMG Only

Data subject to change.

### COLOR CODE CHART 1

For cables up to and including 12 conductors

NO. OF COND.	COLOR	NO. OF COND.	COLOR	NO. OF COND.	COLOR	NO. OF COND.	COLOR
<b>1</b>	Black	<b>4</b>	Green	<b>7</b>	Orange	<b>10</b>	Gray
<b>2</b>	White	<b>5</b>	Brown	<b>8</b>	Yellow	<b>11</b>	Pink
<b>3</b>	Red	<b>6</b>	Blue	<b>9</b>	Purple	<b>12</b>	Tan

### COLOR CODE CHART 2 PER ICEA

For cables of 15 thru 50 conductors

NO. OF COND.	COLOR	NO. OF COND.	COLOR	NO. OF COND.	COLOR	NO. OF COND.	COLOR	NO. OF COND.	COLOR
<b>1</b>	Black	<b>11</b>	Blue/Black	<b>21</b>	Orange/Green	<b>31</b>	Green/Black/Orange	<b>41</b>	Green/White/Blue
<b>2</b>	White	<b>12</b>	Black/White	<b>22</b>	Black/White/Red	<b>32</b>	Orange/Black/Green	<b>42</b>	Orange/Red/Green
<b>3</b>	Red	<b>13</b>	Red/White	<b>23</b>	White/Black/Red	<b>33</b>	Blue/White/Orange	<b>43</b>	Blue/Red/Green
<b>4</b>	Green	<b>14</b>	Green/White	<b>24</b>	Red/Black/White	<b>34</b>	Black/White/Orange	<b>44</b>	Black/White/Blue
<b>5</b>	Orange	<b>15</b>	Blue/White	<b>25</b>	Green/Black/White	<b>35</b>	White/Red/Orange	<b>45</b>	White/Black/Blue
<b>6</b>	Blue	<b>16</b>	Black/Red	<b>26</b>	Orange/Black/White	<b>36</b>	Orange/White/Blue	<b>46</b>	Red/White/Blue
<b>7</b>	White/Black	<b>17</b>	White/Red	<b>27</b>	Blue/Black/White	<b>37</b>	White/Red/Blue	<b>47</b>	Green/Orange/Red
<b>8</b>	Red/Black	<b>18</b>	Orange/Red	<b>28</b>	Black/Red/Green	<b>38</b>	Black/White/Green	<b>48</b>	Orange/Red/Blue
<b>9</b>	Green/Black	<b>19</b>	Blue/Red	<b>29</b>	White/Red/Green	<b>39</b>	White/Black/Green	<b>49</b>	Blue/Red/Orange
<b>10</b>	Orange/Black	<b>20</b>	Red/Green	<b>30</b>	Red/Black/Green	<b>40</b>	Red/White/Green	<b>50</b>	Black/Orange/Red



# Multi-Conductor, Unshielded

UL 2464, UL 2576, NEC/CEC Type CMG UL/CSA\*\*

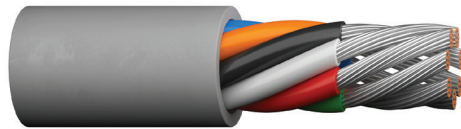

**Product Construction:**

**Conductor:**

- 20 or 18 AWG fully annealed stranded, tinned copper per ASTM B33

**Insulation:**

- Premium-grade, color-coded PVC per UL AWM Style 1007
- Color code: See charts below

**Jacket:**

- PVC, gray
- Temperature range: -20°C to +105°C

**Applications:**

- Public address systems
- Intercoms
- Internal telephones
- Remote control circuits
- Suitable for EIA RS-232 applications
- Suggested voltage rating: 300 volts

**Compliances:**

- NEC Article 800 Type CM (UL: 105°C)
- UL Style 2464 (UL: 80°C, 300 V)
- UL Style 2576 (UL: 80°C, 150 V)
- CSA CMG (CSA: 105°C)
- RoHS Compliant Directive 2015/863/EU (RoHS-3)
- Passes CSA CMG Flame Test
- Sunlight Resistant

**Packaging:**

- Please contact Customer Service for packaging and color options

CATALOG NUMBER	NO. OF COND.	AWG SIZE	COND. STRAND	NOM. INSULATION THICKNESS		NOM. JACKET THICKNESS		NOMINAL O.D.		COLOR CODE	NOM. C-C CAP.* pF/ft
				in	mm	in	mm	in	mm		
C6351A†	2	20	7/28	0.016	0.41	0.025	0.64	0.192	4.88	Black/Red	28.0
C6352A	3	20	7/28	0.016	0.41	0.032	0.81	0.216	5.50	1	28.0
C6353A	4	20	7/28	0.016	0.41	0.032	0.81	0.235	5.97	1	28.0
C6355A	5	20	7/28	0.016	0.41	0.032	0.81	0.254	6.46	1	28.0
C6356A	7	20	7/28	0.016	0.41	0.032	0.81	0.275	6.99	1	28.0
C6357A	9	20	7/28	0.016	0.41	0.032	0.81	0.317	8.05	1	28.0
C6360A	12	20	7/28	0.016	0.41	0.032	0.81	0.354	9.00	2	28.0
C6358A	15	20	7/28	0.016	0.41	0.032	0.81	0.392	9.96	2	28.0
C2830A†	2	18	16/30	0.016	0.41	0.015	0.64	0.190	5.33	Black/Red	30.5
C2831A	3	18	16/30	0.016	0.41	0.032	0.81	0.236	5.99	1	30.5
C2404A	4	18	16/30	0.016	0.41	0.032	0.81	0.258	6.55	1	30.5
C2420A	5	18	16/30	0.016	0.41	0.032	0.81	0.280	7.11	1	30.5
C2421A	7	18	16/30	0.016	0.41	0.032	0.81	0.309	7.85	1	30.5
C2422A	9	18	16/30	0.016	0.41	0.032	0.81	0.358	9.09	1	30.5
C2412A	12	18	16/30	0.016	0.41	0.032	0.81	0.401	10.19	2	30.5
C2423A	15	18	16/30	0.016	0.41	0.032	0.81	0.445	11.30	2	30.5
C2424A	19	18	16/30	0.016	0.41	0.032	0.81	0.469	11.91	2	30.5
C2433A	25	18	16/30	0.016	0.41	0.032	0.81	0.550	13.94	2	30.5

\*Capacitance between conductors

\*\*CSA or c(UL)

†CM (UL) c(UL), CSA CMG Only

Data subject to change.

**COLOR CODE CHART 1**

For cables up to and including 9 conductors

NO. OF COND.	COLOR	NO. OF COND.	COLOR	NO. OF COND.	COLOR
1	Black	4	Green	7	Orange
2	White	5	Brown	8	Yellow
3	Red	6	Blue	9	Purple

**COLOR CODE CHART 2 PER ICEA**

For cables of 12 thru 25 conductors

NO. OF COND.	COLOR	NO. OF COND.	COLOR	NO. OF COND.	COLOR	NO. OF COND.	COLOR	NO. OF COND.	COLOR
1	Black	6	Blue	11	Blue/Black	16	Black/Red	21	Orange/Green
2	White	7	White/Black	12	Black/White	17	White/Red	22	Black/White/Red
3	Red	8	Red/Black	13	Red/White	18	Orange/Red	23	White/Black/Red
4	Green	9	Green/Black	14	Green/White	19	Blue/Red	24	Red/Black/White
5	Orange	10	Orange/Black	15	Blue/White	20	Red/Green	25	Green/Black/White



# Multi-Conductor, Unshielded

UL 2464, UL 2587, NEC Type CL3, NEC/CEC Type CMG UL/CSA\*\*

**Product Construction:**

**Conductor:**

- 16 thru 12 AWG fully annealed stranded tinned copper per ASTM B33

**Insulation:**

- Premium-grade, color-coded PVC
- Color code: See chart below

**Jacket:**

- PVC, gray
- Temperature range: -20°C to +105°C

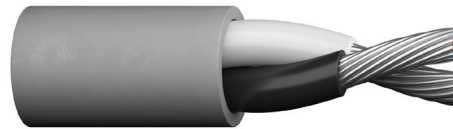

**Applications:**

- Public address systems
- Intercoms
- Internal telephones
- Remote control circuits
- Suitable for EIA RS-232 applications
- Suggested voltage rating: 300 volts

**Compliances:**

- NEC Article 725 Type CL3 (UL: 105°C)
- NEC Article 800 Type CM (UL: 105°C)
- UL Style 2464 (UL: 80°C, 300 V)
- UL Style 2587 (UL: 80°C, 600 V)
- CSA CMG (CSA: 105°C)
- RoHS Compliant Directive 2015/863/EU (RoHS-3)
- Passes CSA CMG Flame Test
- Sunlight Resistant

**Packaging:**

- Please contact Customer Service for packaging and color options

CATALOG NUMBER	NO. OF COND.	AWG SIZE	COND. STRAND	NOM. INSULATION THICKNESS		NOM. JACKET THICKNESS		NOMINAL O.D.		NOM. C-C CAP.* pF/ft
				in	mm	in	mm	in	mm	

**NEC TYPE CM, UL STYLE 2464 (80°C, 300 VOLTS)**

<b>C2405A</b>	2	16	19/0117	0.021	0.53	0.032	0.81	0.260	6.81	30.5
<b>C2406A</b>	3	16	19/0117	0.021	0.53	0.032	0.81	0.283	7.19	30.5
<b>C2425A</b>	4	16	19/0117	0.021	0.53	0.032	0.81	0.306	7.77	30.5
<b>C2434A</b>	5	16	19/0117	0.021	0.53	0.032	0.81	0.334	8.48	30.5
<b>C2426A</b>	7	16	19/0117	0.021	0.53	0.032	0.81	0.363	9.25	30.5
<b>C2443A</b>	8	16	19/0117	0.021	0.53	0.032	0.81	0.393	10.03	30.5
<b>C2435A</b>	9	16	19/0117	0.021	0.53	0.032	0.81	0.423	10.80	30.5
<b>C2427A</b>	12	16	19/0117	0.021	0.53	0.032	0.81	0.476	12.17	30.5
<b>C2428A</b>	15	16	19/0117	0.021	0.53	0.032	0.81	0.530	13.46	30.5
<b>C2429A</b>	19	16	19/0117	0.021	0.53	0.032	0.81	0.559	14.33	30.5
<b>C2436A</b>	25	16	19/0117	0.021	0.53	0.032	0.81	0.657	16.69	30.5

**NEC TYPE CL3, UL STYLE 2587 (90°C, 600 VOLTS)**

<b>C2409A</b>	2	14	19/0147	0.032	0.81	0.032	0.81	0.326	8.51	29.0
<b>C2430A</b>	4	14	19/0147	0.032	0.81	0.032	0.81	0.391	9.93	28.2
<b>C2437A</b>	5	14	19/0147	0.032	0.81	0.032	0.81	0.428	10.87	28.2
<b>C2431A</b>	7	14	19/0147	0.032	0.81	0.032	0.81	0.469	11.91	28.2
<b>C2410A</b>	2	12	19/0.0185	0.032	0.81	0.032	0.81	0.366	9.40	31.0
<b>C2440A</b>	4	12	19/0.0185	0.032	0.81	0.032	0.81	0.437	11.02	31.0

\*Capacitance between conductors

\*\*CSA or c(UL)

Data subject to change.

**COLOR CODE CHART PER ICEA**

NO. OF COND.	COLOR	NO. OF COND.	COLOR	NO. OF COND.	COLOR	NO. OF COND.	COLOR	NO. OF COND.	COLOR
<b>1</b>	Black	<b>6</b>	Blue	<b>11</b>	Blue/Black	<b>16</b>	Black/Red	<b>21</b>	Orange/Green
<b>2</b>	White	<b>7</b>	White/Black	<b>12</b>	Black/White	<b>17</b>	White/Red	<b>22</b>	Black/White/Red
<b>3</b>	Red	<b>8</b>	Red/Black	<b>13</b>	Red/White	<b>18</b>	Orange/Red	<b>23</b>	White/Black/Red
<b>4</b>	Green	<b>9</b>	Green/Black	<b>14</b>	Green/White	<b>19</b>	Blue/Red	<b>24</b>	Red/Black/White
<b>5</b>	Orange	<b>10</b>	Orange/Black	<b>15</b>	Blue/White	<b>20</b>	Red/Green	<b>25</b>	Green/Black/White



# Multi-Conductor, Unshielded

NEC Type CMP (UL) c(UL) and/or CL2P



**Product Construction:**

**Conductor:**

- 22 thru 14 AWG fully annealed stranded tinned or bare copper per ASTM B3, B8 or B33

**Insulation:**

- Premium-grade, color-coded Flexguard® PVC
- Color code: See chart below

**Jacket:**

- Fluoropolymer, natural
- Temperature range: -20°C to +75°C
- Sequential footage marked to facilitate installation
- Abrasion-, chemical- and water-resistant
- Includes ripcord

**Applications:**

- Intercom systems
- Background music
- Audio systems
- Power-limited control circuits
- Suggested voltage rating: 150 volts

**Compliances:**

- NEC Article 725 (UL: 75°C, 150 V)
- NEC Article 800 (UL: 75°C, 300 V)
- Designed to meet NFPA 262 and CSA FT6 Steiner Tunnel Fire Tests for Plenum Applications

**Packaging:**

- Please contact Customer Service for packaging and color options

CATALOG NUMBER	NO. OF COND.	AWG SIZE	COND. STRAND	NOM. INSULATION THICKNESS		NOM. JACKET THICKNESS		NOMINAL O.D.		NOM. C-C CAP,* pF/ft
				in	mm	in	mm	in	mm	
C3105†	2	22	7/30 TC	0.006	0.15	0.010	0.25	0.089	2.26	29.0
C3106†	4	22	7/30 TC	0.006	0.15	0.010	0.25	0.121	3.07	29.0
C3102	2	18	7/26 BC	0.008	0.20	0.010	0.25	0.123	3.12	31.0
C3190	3	18	7/26 BC	0.008	0.20	0.010	0.25	0.143	3.63	31.0
C3103	4	18	7/26 BC	0.008	0.20	0.010	0.25	0.163	4.14	31.0
C3134	5	18	7/26 BC	0.008	0.20	0.010	0.25	0.187	4.75	30.8
C3192	6	18	7/26 BC	0.008	0.20	0.010	0.25	0.198	5.03	31.0
C3191	8	18	7/26 BC	0.008	0.20	0.010	0.25	0.223	5.66	31.0
C3178	10	18	7/26 BC	0.008	0.20	0.010	0.25	0.244	6.19	31.0
C3179	12	18	7/26 BC	0.008	0.20	0.010	0.25	0.263	6.68	31.0
C3193	2	16	19/0117 BC	0.008	0.20	0.010	0.25	0.141	3.58	33.0
C3194	3	16	7/0192 BC	0.008	0.20	0.010	0.25	0.164	4.17	33.0
C3195	4	16	7/0192 BC	0.008	0.20	0.010	0.25	0.187	4.75	33.0
C3126†	2	14	19/0147 BC	0.010	0.25	0.010	0.25	0.168	4.27	35.0
C3135†	2	12	19/0185 BC	0.010	0.25	0.010	0.25	0.238	6.05	37.0

\*Capacitance between conductors

†CL2P only

Data subject to change.

**COLOR CODE CHART**

NO. OF COND.	COLOR	NO. OF COND.	COLOR	NO. OF COND.	COLOR	NO. OF COND.	COLOR
1	Black	4	Green	7	Orange	10	Gray
2	White	5	Brown	8	Yellow	11	Pink
3	Red	6	Blue	9	Purple	12	Tan



Designed to Meet  
NFPA 262 and CSA FT6  
Steiner Tunnel Fire Tests  
for Plenum Applications

Underwriters Laboratories Inc.



# Multi-Conductor, Unshielded

NEC Type CMP (UL) c(UL) and/or CL3P

**Product Construction:**

**Conductor:**

- 22 thru 12 AWG fully annealed solid, stranded tinned or bare copper per ASTM B3, B8 or B33

**Insulation:**

- Premium-grade, color-coded Flexguard® PVC
- Color code: See chart below

**Jacket:**

- Flexguard® PVC, natural
- Temperature range: -20°C to +75°C
- Sequential footage marked to facilitate installation
- Includes ripcord

**Applications:**

- Intercom systems
- Background music
- Audio systems
- Power-limited control circuits
- Suggested voltage rating: 150 volts

**Compliances:**

- NEC Article 725 (UL: 75°C, 150 V)
- NEC Article 800 (UL: 75°C, 300 V)
- RoHS Compliant Directive 2015/863/EU (RoHS-3)
- Designed to meet NFPA 262 and CSA FT6 Steiner Tunnel Fire Tests for Plenum Applications

**Packaging:**

- Please contact Customer Service for packaging and color options

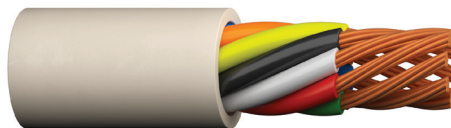

CATALOG NUMBER	NO. OF COND.	AWG SIZE	COND. STRAND	NOM. INSULATION THICKNESS		NOM. JACKET THICKNESS		NOMINAL O.D.		NOM.* C-C CAP. pF/ft
				in	mm	in	mm	in	mm	

**22 AWG CONDUCTORS**

<b>C3115</b>	2	22	7/32 TC	0.008	0.20	0.015	0.38	0.122	3.10	30.0
<b>C3116</b>	4	22	7/32 TC	0.008	0.20	0.015	0.38	0.141	3.58	30.0

**18 AWG CONDUCTORS**

<b>C3110</b>	2	18	Solid BC	0.008	0.20	0.015	0.38	0.142	3.61	37.0
<b>C3114</b>	3	18	Solid BC	0.008	0.20	0.015	0.38	0.151	3.84	37.0
<b>C3111</b>	4	18	Solid BC	0.008	0.20	0.015	0.38	0.166	4.22	37.0
<b>C3117</b>	5	18	Solid BC	0.008	0.20	0.015	0.38	0.182	4.62	37.0
<b>C3118</b>	6	18	Solid BC	0.008	0.20	0.015	0.38	0.199	5.05	37.0
<b>C3119</b>	8	18	Solid BC	0.008	0.20	0.015	0.38	0.216	5.49	37.0
<b>C3112</b>	2	18	7/26 BC	0.008	0.20	0.015	0.38	0.156	3.96	35.0
<b>C3120</b>	3	18	7/26 BC	0.008	0.20	0.015	0.38	0.166	4.22	35.0
<b>C3113</b>	4	18	7/26 BC	0.008	0.20	0.015	0.38	0.182	4.62	35.0
<b>C3125</b>	5	18	7/26 BC	0.008	0.20	0.015	0.38	0.200	5.08	54.6
<b>C3121</b>	6	18	7/26 BC	0.008	0.20	0.015	0.38	0.216	5.49	35.0
<b>C3122</b>	8	18	7/26 BC	0.008	0.20	0.015	0.38	0.239	6.07	35.0
<b>C3123</b>	10	18	7/26 BC	0.008	0.20	0.015	0.38	0.278	7.06	35.0
<b>C3124</b>	12	18	7/26 BC	0.008	0.20	0.015	0.38	0.287	7.29	35.0

**16 AWG CONDUCTORS**

<b>C3127</b>	2	16	19/0117 BC	.009	.227	0.015	0.38	0.178	4.52	40.0
--------------	---	----	------------	------	------	-------	------	-------	------	------

**14 AWG CONDUCTORS**

<b>C3128†</b>	2	14	19/0147 BC	0.010	0.20	0.015	0.38	0.212	5.38	40.0
---------------	---	----	------------	-------	------	-------	------	-------	------	------

**12 AWG CONDUCTORS**

<b>C3129†</b>	2	12	19/0185 BC	0.010	0.20	0.015	0.38	0.254	6.45	43.0
---------------	---	----	------------	-------	------	-------	------	-------	------	------

\*Capacitance between conductors  
 †CL3P only  
 Data subject to change.

**COLOR CODE CHART**

NO. OF COND.	COLOR	NO. OF COND.	COLOR	NO. OF COND.	COLOR	NO. OF COND.	COLOR
<b>1</b>	Black	<b>4</b>	Green	<b>7</b>	Orange	<b>10</b>	Gray
<b>2</b>	White	<b>5</b>	Brown	<b>8</b>	Yellow	<b>11</b>	Pink
<b>3</b>	Red	<b>6</b>	Blue	<b>9</b>	Purple	<b>12</b>	Tan



Underwriters Laboratories Inc.



# Multi-Conductor, Unshielded

AWM Style 2464, CSA Type AWM I/II A/B, NEC/CEC Type CMG (CSA C/US)

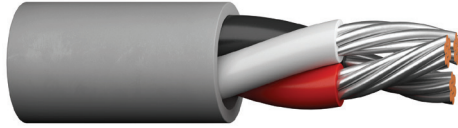

**Product Construction:**

**Conductor:**

- 20 or 18 AWG fully annealed, stranded tinned copper per ASTM B33

**Insulation:**

- Premium-grade, color-coded PVC
- Color code: See charts below

**Jacket:**

- PVC, gray
- Temperature range: -20°C to +105°C

**Applications:**

- Public address systems
- Intercoms
- Internal telephones
- Remote control circuits
- Suitable for EIA RS-232 applications
- Suggested voltage rating: 300 or 600 volts

**Compliances:**

- AWM Style 2464 (UL: 80°C, 300 V)
- CSA Type AWM (105°C, 600 V)
- CSA Certified CMG to harmonized standard UL 444 and CSA 22.2 No. 214
- NEC/CEC Type CMG (CSA: 105°C, 300 V)
- RoHS Compliant Directive 2015/863/EU (RoHS-3)
- Passes CSA FT4 vertical flame test

**Packaging:**

- Please contact Customer Service for packaging and color options

CATALOG NUMBER	NO. OF COND.	AWG SIZE	COND. STRAND	NOM. INSULATION THICKNESS		NOM. JACKET THICKNESS		NOMINAL O.D.		COLOR CODE	NOM. C-C CAP.* pF/ft
				in	mm	in	mm	in	mm		
C4117A	2	20	7/28	0.016	0.30	0.032	0.81	0.206	4.67	Black/Red	31.0
C4118A	3	20	7/28	0.016	0.30	0.032	0.81	0.216	4.90	1	31.0
C4119A	4	20	7/28	0.016	0.30	0.032	0.81	0.235	5.31	1	31.0
C4120A	5	20	7/28	0.016	0.30	0.032	0.81	0.254	5.74	1	31.0
C4121A	7	20	7/28	0.016	0.30	0.032	0.81	0.275	6.20	1	31.0
C4122A	9	20	7/28	0.016	0.30	0.032	0.81	0.317	7.14	1	31.0
C4123A	12	20	7/28	0.016	0.30	0.032	0.81	0.354	7.95	2	31.0
C4124A	15	20	7/28	0.016	0.30	0.032	0.81	0.392	8.36	2	31.0
C4125A	2	18	16/30	0.016	0.30	0.032	0.81	0.224	5.13	Black/Red	34.0
C4214A	2	18	16/30	0.016	0.30	0.032	0.81	0.224	5.13	1	34.0
C4126A	3	18	16/30	0.016	0.30	0.032	0.81	0.236	5.41	1	34.0
C4127A	4	18	16/30	0.016	0.30	0.032	0.81	0.258	5.87	1	34.0
C4128A	5	18	16/30	0.016	0.30	0.032	0.81	0.280	6.35	1	34.0
C4206A	6	18	16/30	0.016	0.30	0.032	0.81	0.304	6.76	1	34.0
C4129A	7	18	16/30	0.016	0.30	0.032	0.81	0.309	6.88	1	34.0
C4130A	9	18	16/30	0.016	0.30	0.032	0.81	0.358	7.98	1	34.0
C4131A	12	18	16/30	0.016	0.30	0.032	0.81	0.401	8.92	2	34.0
C4132A	15	18	16/30	0.016	0.30	0.032	0.81	0.445	9.86	2	34.0
C4133A	19	18	16/30	0.016	0.30	0.032	0.81	0.469	10.39	2	34.0
C4134A	25	18	16/30	0.016	0.30	0.032	0.81	0.549	12.14	2	34.0

\*Capacitance between conductors  
Data subject to change.

**COLOR CODE CHART 1**

For cables up to and including 9 conductors

NO. OF COND.	COLOR	NO. OF COND.	COLOR	NO. OF COND.	COLOR
1	Black	4	Green	7	Orange
2	White	5	Brown	8	Yellow
3	Red	6	Blue	9	Purple

**COLOR CODE CHART 2 PER ICEA**

For cables of 12 thru 25 conductors

NO. OF COND.	COLOR	NO. OF COND.	COLOR	NO. OF COND.	COLOR	NO. OF COND.	COLOR	NO. OF COND.	COLOR
1	Black	6	Blue	11	Blue/Black	16	Black/Red	21	Orange/Green
2	White	7	White/Black	12	Black/White	17	White/Red	22	Black/White/Red
3	Red	8	Red/Black	13	Red/White	18	Orange/Red	23	White/Black/Red
4	Green	9	Green/Black	14	Green/White	19	Blue/Red	24	Red/Black/White
5	Orange	10	Orange/Black	15	Blue/White	20	Red/Green	25	Green/Black/White





# Multi-Conductor, Unshielded

AWM Styles 2464, 2587, CSA Type AWM I/II A/B, NEC/CEC Type CMG (CSA C/US), or NEC Type CL2

**Product Construction:**

**Conductor:**

- 16 thru 12 AWG fully annealed, stranded tinned copper per ASTM B33

**Insulation:**

- Premium-grade, color-coded PVC
- Color code: See chart below

**Jacket:**

- PVC, gray
- Temperature range: -20°C to +105°C



**Applications:**

- Public address systems
- Intercoms
- Internal telephones
- Remote control circuits
- Suitable for EIA RS-232 applications
- Suggested voltage rating: 300 or 600 volts

**Compliances:**

- AWM Style 2464 (UL: 80°C, 300 V)
- AWM Style 2587 (UL: 90°C, 600 V)
- CSA Type AWM (105°C, 600 V)
- CSA Certified CMG to harmonized standard UL 444 and CSA 22.2 No. 214
- NEC/CEC Type CMG (CSA: 105°C, 300 V)
- RoHS Compliant Directive 2015/863/EU (RoHS-3)
- Passes CSA FT4 Vertical Flame Test
- UL Certified CL2 to Standard UL 13

**Packaging:**

- Please contact Customer Service for packaging and color options

CATALOG NUMBER	NO. OF COND.	AWG SIZE	COND. STRAND	NOM. INSULATION THICKNESS		NOM. JACKET THICKNESS		NOMINAL O.D.		NOM. C-C CAP.* pF/ft
				in	mm	in	mm	in	mm	

**AWM STYLE 2464, CSA TYPE AWM, CSA C/US TYPE CMG**

<b>C4135A</b>	2	16	19/0117	0.021	0.53	0.032	0.81	0.268	6.81	27.0
<b>C4136A</b>	3	16	19/0117	0.021	0.53	0.032	0.81	0.283	7.19	27.0
<b>C4137A</b>	4	16	19/0117	0.021	0.53	0.032	0.81	0.306	7.77	27.0
<b>C4138A</b>	5	16	19/0117	0.021	0.53	0.032	0.81	0.334	8.48	27.0
<b>C4139A</b>	7	16	19/0117	0.021	0.53	0.032	0.81	0.364	9.25	27.0
<b>C4140A</b>	8	16	19/0117	0.021	0.53	0.032	0.81	0.395	10.03	27.0
<b>C4141A</b>	9	16	19/0117	0.021	0.53	0.032	0.81	0.425	10.80	27.0
<b>C4142A</b>	12	16	19/0117	0.021	0.53	0.032	0.81	0.479	12.17	27.0
<b>C4143A</b>	15	16	19/0117	0.021	0.53	0.032	0.81	0.530	13.46	27.0
<b>C4144A</b>	19	16	19/0117	0.021	0.53	0.032	0.81	0.564	14.33	27.0
<b>C4145A</b>	25	16	19/0117	0.021	0.53	0.032	0.81	0.657	16.69	27.0

**AWM STYLE 2587, CSA TYPE AWM (FT4), NEC TYPE CL2\*\***

<b>C4146A</b>	2	14	19/0147	0.032	0.81	0.032	0.81	0.334	8.48	25.0
<b>C4147A</b>	4	14	19/0147	0.032	0.81	0.032	0.81	0.391	9.93	25.0
<b>C4148A</b>	5	14	19/0147	0.032	0.81	0.032	0.81	0.428	10.87	25.0
<b>C4149A</b>	7	14	19/0147	0.032	0.81	0.032	0.81	0.469	11.91	25.0
<b>C4150A</b>	2	12	19/0185	0.032	0.81	0.032	0.81	0.370	9.40	29.4
<b>C4151A</b>	4	12	19/0185	0.032	0.81	0.032	0.81	0.434	11.02	29.4

\* Capacitance between conductors  
Data subject to change.

**COLOR CODE CHART 2 PER ICEA**

NO. OF COND.	COLOR	NO. OF COND.	COLOR	NO. OF COND.	COLOR	NO. OF COND.	COLOR	NO. OF COND.	COLOR
<b>1</b>	Black	<b>6</b>	Blue	<b>11</b>	Blue/Black	<b>16</b>	Black/Red	<b>21</b>	Orange/Green
<b>2</b>	White	<b>7</b>	White/Black	<b>12</b>	Black/White	<b>17</b>	White/Red	<b>22</b>	Black/White/Red
<b>3</b>	Red	<b>8</b>	Red/Black	<b>13</b>	Red/White	<b>18</b>	Orange/Red	<b>23</b>	White/Black/Red
<b>4</b>	Green	<b>9</b>	Green/Black	<b>14</b>	Green/White	<b>19</b>	Blue/Red	<b>24</b>	Red/Black/White
<b>5</b>	Orange	<b>10</b>	Orange/Black	<b>15</b>	Blue/White	<b>20</b>	Red/Green	<b>25</b>	Green/Black/White



# Multi-Conductor, Unshielded

AWM Style 2464, CSA Type AWM I/II A/B, NEC/CEC Type CMG (CSA C/US)

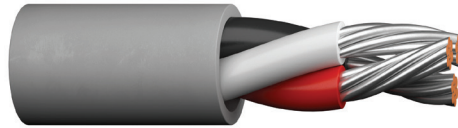

**Product Construction:**

**Conductor:**

- 22 AWG fully annealed, stranded tinned copper per ASTM B33

**Insulation:**

- Premium-grade, color-coded PVC
- Color code: See charts below

**Jacket:**

- PVC, gray
- Temperature range: -20°C to +105°C

**Applications:**

- Public address systems
- Intercoms
- Internal telephones
- Remote control circuits
- Suitable for EIA RS-232 applications
- Suggested voltage rating: 300 or 600 volts

**Compliances:**

- AWM Style 2464 (UL: 80°C, 300 V)
- CSA Type AWM (105°C, 600 V)
- CSA Certified CMG to harmonized standard UL 444 and CSA 22.2 No. 214
- NEC/CEC Type CMG (CSA: 105°C, 300 V)
- RoHS Compliant Directive 2015/863/EU (RoHS-3)
- Passes CSA FT4 vertical flame test

**Packaging:**

- Please contact Customer Service for packaging and color options

CATALOG NUMBER	NO. OF COND.	AWG SIZE	COND. STRAND	NOM. INSULATION THICKNESS		NOM. JACKET THICKNESS		NOMINAL O.D.		COLOR CODE	NOM. C-C CAP.* pF/ft
				in	mm	in	mm	in	mm		
C4100A	2	22	7/30	0.011	0.28	0.032	0.81	0.165	4.19	Black/Red	27.5
C4101A	3	22	7/30	0.011	0.28	0.032	0.81	0.176	4.47	Black/Red/Green	27.5
C4102A	4	22	7/30	0.011	0.28	0.032	0.81	0.189	4.80	1	27.5
C4103A	5	22	7/30	0.011	0.28	0.032	0.81	0.203	5.16	1	27.5
C4104A	6	22	7/30	0.011	0.28	0.032	0.81	0.208	5.28	1	27.5
C4105A	7	22	7/30	0.011	0.28	0.032	0.81	0.218	5.54	1	27.5
C4106A	8	22	7/30	0.011	0.28	0.032	0.81	0.234	5.94	1	27.5
C4107A	9	22	7/30	0.011	0.28	0.032	0.81	0.249	6.32	1	27.5
C4108A	10	22	7/30	0.011	0.28	0.032	0.81	0.268	6.81	1	27.5
C4109A	12	22	7/30	0.011	0.28	0.032	0.81	0.276	7.01	1	27.5
C4110A	15	22	7/30	0.011	0.28	0.032	0.81	0.303	7.70	2	27.5
C4111A	18	22	7/30	0.011	0.28	0.032	0.81	0.318	8.08	2	27.5
C4112A	20	22	7/30	0.011	0.28	0.032	0.81	0.334	8.48	2	27.5
C4113A	25	22	7/30	0.011	0.28	0.032	0.81	0.368	9.35	2	27.5
C4114A	30	22	7/30	0.011	0.28	0.032	0.81	0.389	9.88	2	27.5
C4115A	40	22	7/30	0.011	0.28	0.032	0.81	0.434	11.02	2	27.5
C4116A	50	22	7/30	0.011	0.28	0.032	0.81	0.489	12.42	2	27.5

\*Capacitance between conductors  
Data subject to change.

**COLOR CODE CHART**

For cables up to and including 12 conductors

NO. OF COND.	COLOR	NO. OF COND.	COLOR	NO. OF COND.	COLOR	NO. OF COND.	COLOR
1	Black	4	Green	7	Orange	10	Gray
2	White	5	Brown	8	Yellow	11	Pink
3	Red	6	Blue	9	Purple	12	Tan

**COLOR CODE CHART 2 PER ICEA**

For cables of 15 thru 50 conductors

NO. OF COND.	COLOR	NO. OF COND.	COLOR	NO. OF COND.	COLOR	NO. OF COND.	COLOR	NO. OF COND.	COLOR
1	Black	11	Blue/Black	21	Orange/Green	31	Green/Black/Orange	41	Green/White/Blue
2	White	12	Black/White	22	Black/White/Red	32	Orange/Black/Green	42	Orange/Red/Green
3	Red	13	Red/White	23	White/Black/Red	33	Blue/White/Orange	43	Blue/Red/Green
4	Green	14	Green/White	24	Red/Black/White	34	Black/White/Orange	44	Black/White/Blue
5	Orange	15	Blue/White	25	Green/Black/White	35	White/Red/Orange	45	White/Black/Blue
6	Blue	16	Black/Red	26	Orange/Black/White	36	Orange/White/Blue	46	Red/White/Blue
7	White/Black	17	White/Red	27	Blue/Black/White	37	White/Red/Blue	47	Green/Orange/Red
8	Red/Black	18	Orange/Red	28	Black/Red/Green	38	Black/White/Green	48	Orange/Red/Blue
9	Green/Black	19	Blue/Red	29	White/Red/Green	39	White/Black/Green	49	Blue/Red/Orange
10	Orange/Black	20	Red/Green	30	Red/Black/Green	40	Red/White/Green	50	Black/Orange/Red



# Multi-Conductor, Unshielded

CSA Type AWM I/II A/B, NEC/CEC Type CMG (CSA C/US)

**Product Construction:**

**Conductor:**

- 22 thru 14 AWG fully annealed stranded tinned copper per ASTM B33

**Insulation:**

- Premium-grade, color-coded PVC
- Color code: See charts below

**Jacket:**

- PVC, gray
- Temperature range: -20°C to +105°C
- Includes ripcord

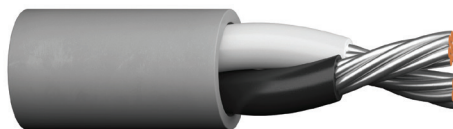

**Applications:**

- Public address systems
- Intercoms
- Internal telephones
- Suggested voltage rating: 300 or 600 volts

**Compliances:**

- CSA Type AWM (105°C, 600 V)
- NEC/CEC Type CMG (CSA: 105°C, 300 V)
- RoHS Compliant Directive 2015/863/EU (RoHS-3)
- Passes CSA FT4 Vertical Flame Test

**Packaging:**

- Please contact Customer Service for packaging and color options

CATALOG NUMBER	NO. OF COND.	AWG SIZE	COND. STRAND	NOM. INS. THICKNESS		NOM. JACKET THICKNESS		NOMINAL O.D.		COLOR CODE	NOM C-C. CAP. pF/ft
				in	mm	in	mm	in	mm		
<b>CSA TYPE AWM, CSA C/US TYPE CMG</b>											
<b>C6700A</b>	2	22	7/30	0.011	0.28	0.016	0.41	0.134	3.40	2	23.5
<b>C6701A</b>	3	22	7/30	0.011	0.28	0.016	0.41	0.142	3.61	2	23.5
<b>C6702A</b>	4	22	7/30	0.011	0.28	0.016	0.41	0.155	3.94	2	23.5
<b>C6704A</b>	6	22	7/30	0.011	0.28	0.016	0.41	0.185	4.70	2	23.5
<b>C6717A</b>	2	20	7/28	0.011	0.28	0.016	0.41	0.148	3.76	2	25.7
<b>C6718A</b>	4	20	7/28	0.011	0.28	0.016	0.41	0.157	3.99	2	25.7
<b>C6725A</b>	2	18	16/30	0.012	0.30	0.016	0.41	0.172	4.37	1	27.3
<b>C6714A</b>	2	18	16/30	0.012	0.30	0.016	0.41	0.172	4.37	2	27.3
<b>C6726A</b>	3	18	16/30	0.012	0.30	0.016	0.41	0.183	4.65	2	27.3
<b>C6727A</b>	4	18	16/30	0.012	0.30	0.016	0.41	0.201	5.11	2	27.3
<b>C6706A</b>	6	18	16/30	0.012	0.30	0.016	0.41	0.242	6.15	2	27.3
<b>C6735A</b>	2	16	19/0117	0.012	0.30	0.016	0.41	0.192	4.88	2	29.4
<b>C6736A</b>	3	16	19/0117	0.012	0.30	0.016	0.41	0.204	5.18	2	29.4
<b>C6737A</b>	4	16	19/0117	0.012	0.30	0.016	0.41	0.226	5.74	2	29.4
<b>CSA TYPE AWM (FT4)</b>											
<b>C6746A</b>	2	14	19/0147	0.015	0.38	0.016	0.41	0.234	5.94	2	30.8
<b>C6747A</b>	4	14	19/0147	0.015	0.38	0.016	0.41	0.276	7.01	2	30.8

\*A – Capacitance between conductors

\*B – Capacitance between one conductor and other conductors connected to shield  
Data subject to change.

**COLOR CODE CHART 1**

NO. OF COND.	COLOR
1	Black
2	White

**COLOR CODE CHART 2**

NO. OF COND.	COLOR
1	Black
2	White
3	Red
4	Green
5	Brown
6	Blue
7	Orange
8	Yellow

# Power-Limited Tray Cable, Unshielded

NEC Type PLTC, NEC/CEC Type CMG UL/CSA\*\*



CATALOG NUMBER	NO. OF COND.	AWG SIZE	COND. STRAND	NOM. INSULATION THICKNESS		NOM. JACKET THICKNESS		NOMINAL O.D.		NOM. C-C CAP.* pF/ft
				in	mm	in	mm	in	mm	
C0431A	2	22	7/30	0.013	0.33	0.037	0.94	0.185	4.70	27.5
C0432A	3	22	7/30	0.013	0.33	0.037	0.94	0.193	4.90	27.5
C0433A	2	20	7/28	0.013	0.33	0.037	0.94	0.198	5.03	30.5
C0434A	3	20	7/28	0.013	0.33	0.037	0.94	0.208	5.28	30.5
C0435A	2	18	16/30	0.013	0.33	0.037	0.94	0.216	5.49	32.5
C0436A	3	18	16/30	0.013	0.33	0.037	0.94	0.227	5.77	32.5
C0444A	4	18	16/30	0.013	0.33	0.037	0.94	0.245	6.22	32.5
C0437A	2	16	19/0117	0.013	0.33	0.037	0.94	0.238	6.05	37.0
C0438A	3	16	19/0117	0.013	0.33	0.037	0.94	0.250	6.35	37.0
C0439A*	2	14	19/0147	0.013	0.33	0.042	1.07	0.278	7.06	40.5
C0440A*	3	14	19/0147	0.013	0.33	0.042	1.07	0.293	7.44	40.5
C0441A*	2	12	19/0185	0.013	0.33	0.042	1.07	0.315	8.00	44.0

\*NEC Type PLTC Only

\*\*CSA or c(UL)

Data subject to change.

## COLOR CODE CHART

NO. OF COND.	COLOR
1	Black
2	Red
3	White
4	Green

### Product Construction:

#### Conductor:

- 22 thru 12 AWG fully annealed stranded tinned copper per ASTM B33

#### Insulation:

- Premium-grade, color-coded PVC
- Color code: See chart below

#### Jacket:

- PVC, gray
- Sunlight-resistant
- Temperature range: -20°C to +105°C

### Applications:

- Cable tray installations
- Power limited circuits
- Intercom systems
- Business machines
- Cash registers
- Automatic valve control systems
- Irrigation systems
- Suggested voltage rating: 300 volts
- Burglar alarms

### Features:

- UL rated for cable tray use

### Compliances:

- NEC Article 725 Power-Limited Tray Cable (UL: 105°C, 300 V)
- NEC/CEC Type CMG (UL/CSA: 105°C, 300 V)
- RoHS Compliant Directive 2015/863/EU (RoHS-3)

### Packaging:

- Please contact Customer Service for packaging and color options



# Multi-Conductor, Foil Shield

NEC Type CL2 and CM (UL) c(UL) CMH

### Product Construction:

#### Conductor:

- 24 thru 12 AWG fully annealed solid or stranded tinned copper per ASTM B33

#### Insulation:

- Premium-grade, color-coded polyethylene
- Premium-grade, color-coded polypropylene
- Color code: See charts below

#### Shield:

- 100% Flexfoil® aluminum/polyester, 25% overlap, foil facing out
- Stranded tinned copper drain wire

#### Jacket:

- PVC, gray
- Temperature range: -20°C to +75°C

#### Applications:

- Recording studios and sound stages
- Broadcast and sound systems
- Computers
- Industrial equipment control
- Suggested voltage rating: 300 or 600 volts

#### Compliances:

- UL Style 2092 (UL: 60°C, 300 V)
- UL Style 2093 (UL: 60°C, 300 V)
- UL Style 2094 (UL: 60°C, 300 V)
- UL Style 2106 (UL: 60°C, 600 V)
- UL Style 2107 (UL: 60°C, 600 V)
- UL Style 2464 (UL: 80°C, 300 V)
- NEC Article 725 Type CL2 (UL: 75°C)
- NEC Article 800 Type CM (UL: 75°C)
- RoHS Compliant Directive 2011/65/EU
- CSA CMH (CSA: 60°C)
- Passes CSA CMH Flame Test
- CE: Low Voltage Directive (LVD) 2006/95/EC

#### Packaging:

- Please contact Customer Service for packaging and color options
- Data subject to change.

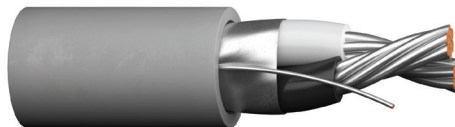

CATALOG NUMBER	NO. OF COND.	AWG SIZE	COND. STRAND	NOM. INSULATION THICKNESS		NOM. JACKET THICKNESS		NOMINAL O.D.		NOM. CAP.***	
				in	mm	in	mm	in	mm	A	B

### UL STYLE 2092, CM (UL) C(UL) CMH, 300 V

<b>C2513A</b>	2	24	7/32	0.016	0.41	0.026	0.66	0.167	4.24	18.0	33.0
<b>C2514A</b>	2	22	7/30	0.016	0.41	0.020	0.51	0.167	4.24	20.0	36.0
<b>C2524A</b>	2	20	7/28	0.016	0.41	0.020	0.51	0.183	4.65	22.5	40.5
<b>C2534A</b>	2	18	16/30	0.016	0.41	0.020	0.51	0.201	5.21	25.5	45.5

Polyethylene Insulation, Color Code Chart #1

### UL STYLE 2093, CM (UL) c(UL) CMH, 300 V

<b>C2526A</b>	3	22	7/30	0.016	0.41	0.030	0.76	0.196	4.98	18.5	33.5
<b>C2528A</b>	3	20	7/28	0.016	0.41	0.030	0.76	0.210	5.34	21.0	37.5
<b>C2525A</b>	3	20	7/28	0.016	0.41	0.030	0.76	0.213	5.41	21.0	37.0
<b>C2535A</b>	3	18	16/30	0.016	0.41	0.020	0.51	0.213	5.56	23.0	41.0

Polyethylene Insulation, Color Code Chart #1

### UL STYLE 2094, CM (UL) c(UL) CMH, 300 V

<b>C2523A</b>	4	22	7/30	0.016	0.41	0.030	0.76	0.213	5.41	18.5	33.5
<b>C2555A</b>	4	20	7/28	0.016	0.41	0.030	0.76	0.234	5.94	20.5	36.5

Polyethylene Insulation, Color Code Chart #1

### UL STYLE 2311, CSA, 600 V

<b>C2536A*</b>	2	16	19/0117	0.031	0.79	0.032	0.81	0.307	7.80	20.0	36.0
<b>C2538A**</b>	2	14	19/0147	0.031	0.79	0.032	0.81	0.335	8.51	23.0	42.0
<b>C2539A**</b>	2	12	19/0185	0.032	0.81	0.032	0.81	0.376	9.55	26.0	46.0

\* CM (UL) c(UL) CMH

\*\* CL2

Polyethylene Insulation, Color Code Chart #1

### UL STYLE 2464, CL2/CM (UL) c(UL) CMH, 300 V

<b>C2540A</b>	2	20	7/28	0.013	0.33	0.032	0.81	0.194	4.9	49.7	89.5
---------------	---	----	------	-------	------	-------	------	-------	-----	------	------

PVC Insulation, Color Code Chart #2

### CM (UL) c(UL) CMH, 300 V

<b>C2515A</b>	2	22	Solid	0.007	0.18	0.020	0.51	0.124	3.15	30.0	55.0
<b>C2516A</b>	2	22	7/30	0.008	0.20	0.020	0.51	0.137	3.48	28.0	51.0
<b>C2517A</b>	3	22	7/30	0.008	0.20	0.020	0.51	0.144	3.36	25.0	45.0

Polypropylene Insulation, Color Code Chart #2

\*\*\*A – Capacitance between conductors

\*\*\*B – Capacitance between one conductor and other conductors connected to shield

#### COLOR CODE CHART 1

NO. OF COND.	COLOR
1	Black
2	Natural
3	Red
4	Green

#### COLOR CODE CHART 1

NO. OF COND.	COLOR
1	Black
2	Red
3	Neutral

# Multi-Conductor, Foil Shield

UL 2092, NEC Type CM (UL) c(UL) CMH

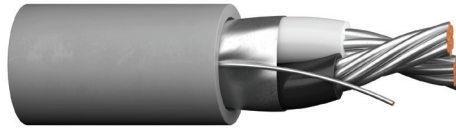

CATALOG NUMBER	NO. OF COND.	AWG SIZE	COND. STRAND	NOM. INSULATION THICKNESS		NOM. JACKET THICKNESS		NOMINAL O.D.		NOM. CAP.* pF/ft	
				in	mm	in	mm	in	mm	A	B

### UL STYLE 2092, CM (UL) C(UL) CMH, 300 V

<b>C2518A</b>	2	22	7/30	0.016	0.41	0.026	0.66	0.181	4.60	20.0	36.0
<b>C2519A</b>	2	20	7/28	0.016	0.41	0.028	0.71	0.201	5.11	21.5	38.5
<b>C2521A</b>	2	18	16/30	0.018	0.46	0.028	0.71	0.229	5.82	23.5	43.0

Polyethylene Insulation, Color Code Chart #1

### CM (UL) C(UL) CMH, CSA CMG, 300 V

<b>C2520A</b>	2	22	7/30	0.008	0.20	0.020	0.51	0.137	3.48	28.0	50.0
---------------	---	----	------	-------	------	-------	------	-------	------	------	------

Polypropylene Insulation, Color Code Chart #2

\*A – Capacitance between conductors

\*B – Capacitance between one conductor and other conductors connected to shield

Data subject to change.

#### COLOR CODE CHART 1

NO. OF COND.	COLOR
<b>1</b>	Black
<b>2</b>	Neutral

#### COLOR CODE CHART 2

NO. OF COND.	COLOR
<b>1</b>	Black
<b>2</b>	Red

#### Product Construction:

##### Conductor:

- 22 thru 18 AWG fully annealed stranded tinned copper per ASTM B33

##### Insulation:

- Premium-grade, color-coded polyethylene or polypropylene
- Color code: See charts below

##### Shield:

- 100% aluminum/polyester foil "bonded" to jacket, foil facing in
- Stranded tinned copper drain wire

##### Jacket:

- PVC, gray
- Temperature range: -20°C to +75°C

#### Applications:

- Control circuits
- Data and signal transmission
- Computer interconnections
- Suggested voltage rating: 300 volts

#### Compliances:

- NEC Article 800 Type CM (UL: 75°C)
- UL Style 2092 (UL: 60°C, 300 V)
- CSA CMH (CSA: 60°C)
- CSA CMG (CSA: 60°C)
- RoHS Compliant Directive 2015/863/EU (RoHS-3)
- Passes CSA CMH Flame Test

#### Packaging:

- Please contact Customer Service for packaging and color options

# Multi-Conductor, Foil Shield

UL 2464, NEC/CEC Type CMG UL/CSA\*\*

**Product Construction:**

**Conductor:**

- 18 AWG fully annealed stranded tinned copper per ASTM B33

**Insulation:**

- Premium-grade, color-coded PVC
- Color code: See chart below

**Shield:**

- 100% Flexfoil® aluminum/polyester, 25% overlap, foil facing out
- Stranded tinned copper drain wire

**Jacket:**

- PVC, gray
- Temperature range: -20°C to +105°C

**Applications:**

- Audio, broadcast, instrumentation and sound systems
- Suggested voltage rating: 300 volts

**Compliances:**

- NEC Article 800 Type CM (UL: 105°C)
- UL Style 2464 (UL: 105°C, 300 V)
- CSA CMG (105°C)
- RoHS Compliant Directive 2015/863/EU (RoHS-3)
- Passes CSA CMG Flame Test

**Packaging:**

- Please contact Customer Service for packaging and color options

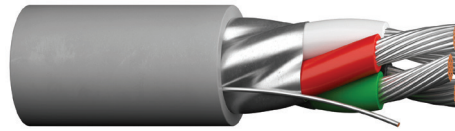

CATALOG NUMBER	NO. OF COND.	AWG SIZE	COND. STRAND	NOM. INSULATION THICKNESS		NOM. JACKET THICKNESS		NOMINAL O.D.		NOM. CAP.* pF/ft	
				in	mm	in	mm	in	mm	A	B
<b>C2543A</b>	4	18	19/30	0.010	0.25	0.032	0.81	0.238	6.05	47	84.5

\*A – Capacitance between conductors

\*B – Capacitance between one conductor and other conductors connected to shield

\*\*CSA or c(UL)

Data subject to change.

**COLOR CODE CHART**

NO. OF COND.	COLOR
<b>1</b>	Black
<b>2</b>	Red
<b>3</b>	White
<b>4</b>	Green



# Multi-Conductor, Foil Shield

NEC Type CMP (UL) c(UL) and CL3P

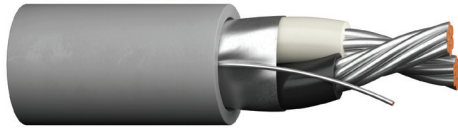

CATALOG NUMBER	NO. OF COND.	AWG SIZE	COND. STRAND	NOM. INSULATION THICKNESS		NOM. JACKET THICKNESS		NOMINAL O.D.		NOM. CAP.* pF/ft	
				in	mm	in	mm	in	mm	A	B
C3158	2	22	7/30 TC	0.008	0.20	0.015	0.38	0.127	3.23	51.0	91.0
C3159	4	22	7/30 TC	0.008	0.20	0.015	0.38	0.146	3.71	45.0	81.0
C3060	2	18	Solid BC	0.008	0.20	0.015	0.38	0.148	3.76	67.0	120.0
C3061	4	18	Solid BC	0.008	0.20	0.015	0.38	0.171	4.34	58.0	104.0
C3062	2	18	7/26 BC	0.008	0.20	0.015	0.38	0.164	4.17	61.0	110.0
C3064	3	18	7/26 BC	0.008	0.20	0.015	0.38	0.169	4.29	53.0	96.0
C3063	4	18	7/26 BC	0.008	0.20	0.015	0.38	0.185	4.70	53.0	96.0
C3065	6	18	7/26 BC	0.010	0.25	0.015	0.38	0.230	5.84	48.0	86.0
C3183	10	18	7/26 BC	0.010	0.25	0.015	0.38	0.295	7.49	47.0	84.0
C3184	12	18	7/26 BC	0.010	0.25	0.015	0.38	0.308	7.82	52.5	94.6
C3068	2	16	19/0117 BC	0.009	0.23	0.015	0.38	0.187	4.75	75.0	134.0

\*A – Capacitance between conductors

\*B – Capacitance between one conductor and other conductors connected to shield

Data subject to change.

**Product Construction:**

**Conductor:**

- 22 thru 16 AWG fully annealed stranded tinned or bare copper per ASTM B3, B8 or B33

**Insulation:**

- Premium-grade, color-coded Flexguard® PVC
- Color code: See chart below

**Shield:**

- 100% Flexfoil® aluminum/polyester foil with 25% overlap, minimum
- Stranded tinned copper drain wire

**Jacket:**

- Flexguard® PVC, natural
- Temperature range: -20°C to +75°C
- Sequential footage marked to facilitate installation
- Includes ripcord

**Applications:**

- Intercom systems
- Background music
- Audio systems
- Power-limited control circuits
- Suggested voltage rating: 300 volts

**Compliances:**

- NEC Article 725 (UL: 75°C, 150 V)
- NEC Article 800 (UL: 75°C, 300 V)
- RoHS Compliant Directive 2011/65/EU
- Designed to meet NFPA 262 and CSA FT6 Steiner Tunnel Fire Tests for Plenum Applications

**Packaging:**

- Please contact Customer Service for packaging and color options

**COLOR CODE CHART 2**

NO. OF COND.	COLOR
1	Black
2	White
3	Red
4	Green
5	Brown
6	Blue
7	Orange
8	Yellow
9	Purple
10	Gray
11	Pink
12	Tan



Designed to Meet  
NFPA 262 and CSA FT6  
Steiner Tunnel Fire Tests  
for Plenum Applications

Underwriters Laboratories Inc.





# Multi-Conductor, Foil Shield

Various AWM Styles, CSA Type AWM I/II A/B, NEC/CEC Type CMG (CSA C/US), NEC Type CL2

**Product Construction:**

**Conductor:**

- 24 thru 12 AWG fully annealed solid or stranded tinned copper per ASTM B33

**Insulation:**

- Premium-grade, color-coded polypropylene
- Color code: See charts below

**Shield:**

- 100% Flexfoil® aluminum/polyester, 25% overlap, foil facing out
- Stranded tinned copper drain wire

**Jacket:**

- PVC, gray
- Temperature range: -20°C to +80°C

**Applications:**

- Recording studios and sound stages
- Broadcast and sound systems
- Computers
- Industrial equipment control
- Suggested voltage rating: 300 or 600 volts

**Compliances:**

- AWM Style 2772 (UL: 60°C,
- CSA Type AWM (80°C, 600 V)
- CSA Certified CMG to harmonized standard UL 444 and CSA 22.2 No. 214
- NEC Type CL2/CEC Type CMG (CSA: 75°C, 300 V)
- RoHS Compliant Directive 2015/863/EU (RoHS-3)
- Passes CSA FT4 Vertical Flame Test

**Packaging:**

- Please contact Customer Service for packaging and color options

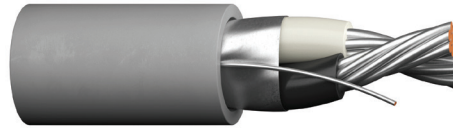

CATALOG NUMBER	NO. OF COND.	AWG SIZE	COND. STRAND	NOM. INSULATION THICKNESS		NOM. JACKET THICKNESS		NOMINAL O.D.		NOM. CAP.* pF/ft	
				in	mm	in	mm	in	mm	A	B

**AWM STYLE 2772, CSA TYPE AWM, CSA C/US TYPE CMG**

<b>C4152A</b>	2	24	7/32	0.016	0.41	0.030	0.66	0.167	4.24	23.0	42.0
<b>C4153A</b>	2	22	7/30	0.016	0.41	0.030	0.66	0.179	4.55	21.0	38.0
<b>C4154A</b>	2	20	7/28	0.016	0.41	0.030	0.76	0.203	5.16	22.0	40.0
<b>C4155A</b>	2	18	16/30	0.018	0.46	0.030	0.76	0.233	5.92	24.0	43.0
<b>C4156A</b>	3	22	7/30	0.016	0.41	0.030	0.76	0.196	4.98	25.0	45.0
<b>C4157A</b>	3	20	7/28	0.016	0.41	0.030	0.76	0.210	5.33	27.0	51.0
<b>C4158A</b>	3	20	7/28	0.016	0.41	0.030	0.76	0.213	5.41	29.0	52.0
<b>C4159A</b>	3	18	16/30	0.018	0.46	0.030	0.76	0.247	6.27	22.0	40.0
<b>C4160A</b>	4	22	7/30	0.016	0.41	0.030	0.76	0.213	5.41	23.0	42.0
<b>C4161A</b>	4	20	7/28	0.016	0.41	0.030	0.76	0.234	5.94	26.0	74.0

Color Code Chart #1

**AWM STYLE 2311, CSA TYPE AWM, CSA C/US TYPE CMG**

<b>C4162A</b>	2	16	19/0117	0.032	0.81	0.032	0.81	0.307	7.80	27.0	49.0
---------------	---	----	---------	-------	------	-------	------	-------	------	------	------

Color Code Chart #1

**NEC TYPE CL2, AWM STYLE 2464, CSA TYPE AWM**

<b>C4163A</b>	2	14	41/30	0.020	0.51	0.032	0.81	0.298	7.57	31.0	56.0
---------------	---	----	-------	-------	------	-------	------	-------	------	------	------

Color Code Chart #3

**NEC TYPE CL2, AWM STYLE 2311, CSA TYPE AWM**

<b>C4164A</b>	2	12	19/0185	0.032	0.81	0.040	1.02	0.390	9.90	35.0	63.0
---------------	---	----	---------	-------	------	-------	------	-------	------	------	------

Color Code Chart #1

**AWM STYLE 2094, CSA TYPE AWM, CSA C/US TYPE CMG**

<b>C4167A</b>	2	22	Solid	0.016	0.18	0.020	0.51	0.124	3.15	40.0	76.0
<b>C4168A</b>	2	22	7/30	0.016	0.20	0.020	0.51	0.137	3.48	34.0	67.0
<b>C4169A</b>	3	22	7/30	0.016	0.20	0.020	0.51	0.144	3.66	32.0	60.0

Polyethylene Insulation, Color Code Chart #2

\*A - Capacitance between conductors

\*B - Capacitance between one conductor and other conductors connected to shield

Data subject to change.

**COLOR CODE CHART 1**

NO. OF COND.	COLOR
1	Black
2	Natural
3	Red
4	Green

**COLOR CODE CHART 2**

NO. OF COND.	COLOR
1	Black
2	Red
3	Clear

**COLOR CODE CHART 3**

NO. OF COND.	COLOR
1	Black
2	White

# Multi-Conductor, Foil Shield

AWM Styles 2464, CSA Type AWM I/II A/B, NEC/CEC Type CMG (CSA C/US), or NEC Type CL2

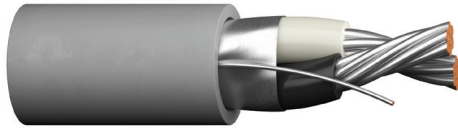

**Product Construction:**

**Conductor:**

- 22 thru 12 AWG fully annealed stranded tinned copper per ASTM B33

**Insulation:**

- Premium-grade, color-coded PVC
- Color code: See charts below

**Shield:**

- 100% Flexfoil® aluminum/polyester, 25% overlap, foil facing out
- Stranded tinned copper drain wire

**Jacket:**

- PVC, gray
- Temperature range: -20°C to +105°C

**Applications:**

- Recording studios and sound stages
- Broadcast and sound systems
- Industrial equipment control
- Suitable for EIA RS-232 applications
- Suggested voltage rating: 300 or 600 volts

**Compliances:**

- AWM Style 2464 (UL: 80°C, 300 V)
- CSA Type AWM (105°C, 600 V)
- CSA Certified CMG to harmonized standard UL 444 and CSA 22.2 No. 214
- NEC/CEC Type CMG (CSA: 105°C, 300 V)
- RoHS Compliant Directive 2015/863/EU (RoHS-3)
- Passes CSA FT4 Vertical Flame Test
- UL Certified CL2 to Standard UL 13
- Sunlight Resistant

**Packaging:**

- Please contact Customer Service for packaging and color options

CATALOG NUMBER	NO. OF COND.	AWG SIZE	COND. STRAND	NOM. INSULATION THICKNESS		NOM. JACKET THICKNESS		NOMINAL O.D.		COLOR CODE	NOM. CAP.* pF/ft	
				in	mm	in	mm	in	mm		A	B

**AWM STYLE 2464, CSA TYPE AWM, CSA C/US TYPE CMG**

C4192A	2	22	7/30	0.011	0.28	0.032	0.81	0.171	4.34	1	47.0	85.0
C4210A	2	22	7/30	0.011	0.28	0.032	0.81	0.171	4.34	2	47.0	85.0
C4193A	3	22	7/30	0.011	0.28	0.032	0.81	0.179	4.55	2	43.0	76.0
C4194A	4	22	7/30	0.011	0.28	0.032	0.81	0.192	4.88	2	43.0	76.0
C4207A	6	22	7/30	0.011	0.28	0.032	0.81	0.218	5.54	2	43.0	76.0
C4208A	8	22	7/30	0.011	0.28	0.032	0.81	0.238	6.05	2	43.0	76.0
C4166A	2	20	7/28	0.012	0.30	0.032	0.81	0.189	4.80	1	46.0	83.0
C4211A	2	20	7/28	0.012	0.30	0.032	0.81	0.189	4.80	2	46.0	83.0
C4195A	3	20	7/28	0.012	0.30	0.032	0.81	0.200	5.08	2	42.0	75.0
C4196A	4	20	7/28	0.012	0.30	0.032	0.81	0.216	5.49	2	42.0	75.0
C4197A	2	18	16/30	0.012	0.30	0.032	0.81	0.205	5.20	1	51.0	92.0
C4212A	2	18	16/30	0.012	0.30	0.032	0.81	0.205	5.20	2	51.0	92.0
C4198A	3	18	16/30	0.012	0.30	0.032	0.81	0.214	5.44	2	46.0	83.0
C4204A	4	18	16/30	0.012	0.30	0.032	0.81	0.236	5.99	2	46.0	83.0
C4205A	6	18	16/30	0.012	0.30	0.032	0.81	0.271	6.88	2	46.0	83.0
C4199A	2	16	19/0117	0.012	0.30	0.032	0.81	0.229	5.82	1	62.0	112.0
C4213A	2	16	19/0117	0.012	0.30	0.032	0.81	0.229	5.82	2	62.0	112.0
C4200A	3	16	19/0117	0.012	0.30	0.032	0.81	0.241	6.12	2	58.0	104.0

**AWM STYLE 2464, CSA TYPE AWM (FT4), NEC TYPE CL2\***

C4201A	2	14	19/0147	0.015	0.38	0.032	0.81	0.271	6.88	1	60.0	107.0
C4215A	2	14	19/0147	0.015	0.38	0.032	0.81	0.271	6.88	2	60.0	107.0
C4202A	2	12	19/0185	0.015	0.38	0.032	0.81	0.307	7.80	1	64.0	116.0

\*A – Capacitance between conductors

\*B – Capacitance between one conductor and other conductors connected to shield

Data subject to change.

**COLOR CODE CHART 1**

NO. OF COND.	COLOR
1	Black
2	Red

**COLOR CODE CHART 2**

For cables up to and including 9 conductors

NO. OF COND.	COLOR	NO. OF COND.	COLOR
1	Black	5	Brown
2	White	6	Blue
3	Red	7	Orange
4	Green	8	Yellow



# Multi-Conductor, Foil Shield

AWM Style 2464, CSA Type AWM I/II A/B, NEC/CEC Type CMG (CSA C/US)

**Product Construction:**

**Conductor:**

- 24 AWG fully annealed stranded tinned copper per ASTM B33

**Insulation:**

- Premium-grade, color-coded PVC
- Color code: See charts below

**Shield:**

- 100% Flexfoil® aluminum/polyester with 25% overlap, foil facing out
- Stranded tinned copper drain wire

**Jacket:**

- PVC, gray
- Temperature range: -20°C to +105°C

**Applications:**

- Computer interconnections
- Data transmission
- Control circuits
- Industrial equipment control
- Suitable for EIA RS-232 applications
- Suggested voltage rating: 300 or 600 volts

**Compliances:**

- AWM Style 2464 (UL: 80°C, 300 V)
- CSA Type AWM (105°C, 600 V)
- CSA Certified CMG to harmonized standard UL 444 and CSA 22.2 No. 214
- NEC/CEC Type CMG (CSA: 105°C, 300 V)
- RoHS Compliant Directive 2015/863/EU (RoHS-3)
- Passes CSA FT4 Vertical Flame Test

**Packaging:**

- Please contact Customer Service for packaging and color options

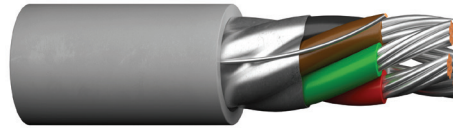

CATALOG NUMBER	NO. OF COND.	AWG SIZE	COND. STRAND	NOMINAL INSULATION THICKNESS		NOMINAL JACKET THICKNESS		NOMINAL O.D.		NOMINAL DCR Ω/kft @20°C		NOMINAL CAP.* pF/ft	
				in	mm	in	mm	in	mm	COND.	SHLD.	A	B

**AWM STYLE 2464, CSA TYPE AWM, CSA C/US TYPE CMG**

C4216A	2	24	7/32	0.010	0.25	0.032	0.81	0.157	3.99	27.7	18.0	40.0	72.0
C4217A	3	24	7/32	0.010	0.25	0.032	0.81	0.164	4.17	27.7	18.0	36.0	66.0
C4218A	4	24	7/32	0.010	0.25	0.032	0.81	0.175	4.45	27.7	18.0	36.0	66.0
C4219A	5	24	7/32	0.010	0.25	0.032	0.81	0.188	4.78	27.7	16.0	36.0	66.0
C4220A	6	24	7/32	0.010	0.25	0.032	0.81	0.201	5.11	27.7	16.0	34.0	61.0
C4221A	7	24	7/32	0.010	0.25	0.032	0.81	0.201	5.11	27.7	16.0	34.0	61.0
C4222A	8	24	7/32	0.010	0.25	0.032	0.81	0.215	5.46	27.7	16.0	34.0	61.0
C4223A	9	24	7/32	0.010	0.25	0.032	0.81	0.228	5.79	27.7	16.0	34.0	61.0
C4224A	10	24	7/32	0.010	0.25	0.032	0.81	0.245	6.22	27.7	14.0	34.0	61.0

Color Code Chart #1

C4225A	15	24	7/32	0.010	0.25	0.032	0.81	0.276	7.01	27.7	14.0	34.0	61.0
C4226A	20	24	7/32	0.010	0.25	0.032	0.81	0.303	7.70	27.7	14.0	34.0	61.0
C4227A	25	24	7/32	0.010	0.25	0.032	0.81	0.333	8.46	27.7	12.0	34.0	61.0
C4228A	30	24	7/32	0.010	0.25	0.032	0.81	0.351	8.92	27.7	12.0	34.0	61.0
C4229A	40	24	7/32	0.010	0.25	0.032	0.81	0.391	9.93	27.7	12.0	34.0	61.0
C4230A	50	24	7/32	0.010	0.25	0.032	0.81	0.439	11.15	27.7	10.0	34.0	61.0

Color Code Chart #2

\*A – Capacitance between conductors

\*B – Capacitance between one conductor and other conductors connected to shield

Data subject to change.

**COLOR CODE CHART**

For cables up to and including 10 conductors

NO. OF COND.	COLOR	NO. OF COND.	COLOR	NO. OF COND.	COLOR	NO. OF COND.	COLOR
1	Black	4	Green	7	Orange	10	Gray
2	White	5	Brown	8	Yellow		
3	Red	6	Blue	9	Purple		

**COLOR CODE CHART 2 PER ICEA**

For cables of 15 thru 50 conductors

NO. OF COND.	COLOR	NO. OF COND.	COLOR	NO. OF COND.	COLOR	NO. OF COND.	COLOR	NO. OF COND.	COLOR
1	Black	11	Blue/Black	21	Orange/Green	31	Green/Black/Orange	41	Green/White/Blue
2	White	12	Black/White	22	Black/White/Red	32	Orange/Black/Green	42	Orange/Red/Green
3	Red	13	Red/White	23	White/Black/Red	33	Blue/White/Orange	43	Blue/Red/Green
4	Green	14	Green/White	24	Red/Black/White	34	Black/White/Orange	44	Black/White/Blue
5	Orange	15	Blue/White	25	Green/Black/White	35	White/Red/Orange	45	White/Black/Blue
6	Blue	16	Black/Red	26	Orange/Black/White	36	Orange/White/Blue	46	Red/White/Blue
7	White/Black	17	White/Red	27	Blue/Black/White	37	White/Red/Blue	47	Green/Orange/Red
8	Red/Black	18	Orange/Red	28	Black/Red/Green	38	Black/White/Green	48	Orange/Red/Blue
9	Green/Black	19	Blue/Red	29	White/Red/Green	39	White/Black/Green	49	Blue/Red/Orange
10	Orange/Black	20	Red/Green	30	Red/Black/Green	40	Red/White/Green	50	Black/Orange/Red



# Multi-Conductor, Foil Shield

CSA Type AWM I/II A/B, NEC/CEC Type CMG (CSA C/US)

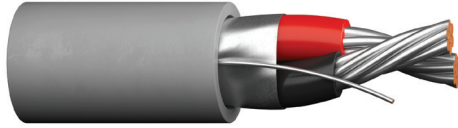

**Product Construction:**

**Conductor:**

- 22 thru 14 AWG fully annealed stranded tinned copper per ASTM B33

**Insulation:**

- Premium-grade, color-coded PVC
- Color code: See charts below

**Shield:**

- 100% Flexfoil® aluminum/polyester foil with 25% overlap, minimum
- Stranded tinned copper drain wire

**Jacket:**

- PVC, gray
- Temperature range: -20°C to +105°C
- Includes ripcord

**Applications:**

- Recording studios and sound stages
- Broadcast and sound systems
- Suggested voltage rating: 300 or 600 volts

**Compliances:**

- CSA Type AWM (105°C, 600 V)
- NEC/CEC Type CMG (CSA: 105°C, 300 V)
- RoHS Compliant Directive 2015/863/EU (RoHS-3)
- Passes CSA FT4 Vertical Flame Test

**Packaging:**

- Please contact Customer Service for packaging and color options

CATALOG NUMBER	NO. OF COND.	AWG SIZE	COND. STRAND	NOM. INS. THICKNESS		NOM. JACKET THICKNESS		NOMINAL O.D.		COLOR CODE	NOM. CAP.* pF/ft	
				in	mm	in	mm	in	mm		A	B

**CSA TYPE AWM, CSA C/US TYPE CMG**

C6892A	2	22	7/30	0.011	0.28	0.016	0.41	0.139	3.53	1	37.7	67.8
C6810A	2	22	7/30	0.011	0.28	0.016	0.41	0.139	3.53	2	37.7	67.8
C6893A	3	22	7/30	0.011	0.28	0.016	0.41	0.147	3.73	2	34.3	61.7
C6894A	4	22	7/30	0.011	0.28	0.016	0.41	0.160	4.06	2	34.3	61.7
C6807A	6	22	7/30	0.011	0.28	0.016	0.41	0.190	4.83	2	31.7	57.0
C6866A	2	20	7/28	0.011	0.28	0.016	0.41	0.153	3.89	1	42.2	76.0
C6811A	2	20	7/28	0.011	0.28	0.016	0.41	0.153	3.89	2	38.0	68.4
C6896A	4	20	7/28	0.011	0.28	0.016	0.41	0.177	4.50	2	34.8	62.7
C6897A	2	18	16/30	0.012	0.30	0.016	0.41	0.175	4.45	1	45.4	81.6
C6812A	2	18	16/30	0.012	0.30	0.016	0.41	0.175	4.45	2	45.4	81.6
C6898A	3	18	16/30	0.012	0.30	0.016	0.41	0.185	4.70	2	40.5	72.9
C6804A	4	18	16/30	0.012	0.30	0.016	0.41	0.204	5.18	2	40.5	72.9
C6805A	6	18	16/30	0.012	0.30	0.016	0.41	0.244	6.20	2	36.9	68.4
C6899A	2	16	19/0117	0.012	0.30	0.016	0.41	0.197	5.00	1	53.6	96.4
C6813A	2	16	19/0117	0.012	0.30	0.016	0.41	0.197	5.00	2	53.6	96.4
C6800A	3	16	19/0117	0.012	0.30	0.016	0.41	0.209	5.31	2	47.0	84.6
C6837A	4	16	19/0117	0.012	0.30	0.016	0.41	0.231	5.87	2	47.0	84.6

**CSA TYPE AWM (FT4)**

C6801A	2	14	19/0147	0.015	0.38	0.016	0.41	0.239	6.07	1	54.0	97.2
C6815A	2	14	19/0147	0.015	0.38	0.016	0.41	0.239	6.07	2	54.0	97.2

\*A – Capacitance between conductors

\*B – Capacitance between one conductor and other conductors connected to shield

Data subject to change.

**COLOR CODE CHART 1**

NO. OF COND.	COLOR
1	Black
2	Red

**COLOR CODE CHART 2**

NO. OF COND.	COLOR	NO. OF COND.	COLOR
1	Black	5	Brown
2	White	6	Blue
3	Red	7	Orange
4	Green	8	Yellow

# Power-Limited Tray Cable, Foil Shield

NEC Type PLTC, NEC/CEC Type CMG UL/CSA\*\*

**Product Construction:**

**Conductor:**

- 22 thru 12 AWG fully annealed stranded tinned copper per ASTM B33

**Insulation:**

- Premium-grade, color-coded PVC
- Color code: See chart below

**Shield:**

- 100% Flexfoil® aluminum/polyester, 25% overlap foil facing out
- Stranded tinned copper drain wire

**Jacket:**

- PVC, gray
- Sunlight-resistant
- Temperature range: -20°C to +105°C

**Applications:**

- Cable tray installations
- Power limited circuits
- Intercom systems
- Business machines
- Cash registers
- Industrial control systems
- Petrochemical refineries
- Suggested voltage rating: 300 volts
- Burglar alarms
- UL tray cable rated

**Compliances:**

- NEC Article 725 Power-Limited Tray Cable (UL: 105°C, 300 V)
- NEC/CEC Type CMG (UL/CSA: 105°C, 300 V)
- RoHS Compliant Directive 2015/863/EU (RoHS-3)

**Packaging:**

- Please contact Customer Service for packaging and color options

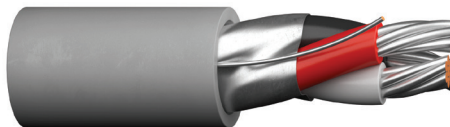

CATALOG NUMBER	NO. OF COND.	AWG SIZE	COND. STRAND	NOM. INSULATION THICKNESS		NOM. JACKET THICKNESS		NOMINAL O.D.		NOM. CAP.* pF/ft	
				in	mm	in	mm	in	mm	A	B
C0450A	2	22	7/30	0.013	0.33	0.037	0.94	0.191	4.85	43.0	77.5
C0451A	3	22	7/30	0.013	0.33	0.037	0.94	0.199	5.05	39.5	71.0
C0452A	2	20	7/28	0.013	0.33	0.037	0.94	0.207	5.26	48.5	87.0
C0453A	3	20	7/28	0.013	0.33	0.037	0.94	0.217	5.51	44.0	79.0
C0454A	2	18	16/30	0.013	0.33	0.037	0.94	0.221	5.61	54.5	98.0
C0455A	3	18	16/30	0.013	0.33	0.037	0.94	0.232	5.89	49.0	88.0
C0456A	2	16	19/0117	0.013	0.33	0.037	0.94	0.243	6.17	64.0	115.5
C0457A	3	16	19/0117	0.013	0.33	0.037	0.94	0.255	6.48	56.5	102.0
C0458A**	2	14	19/0147	0.013	0.33	0.042	1.07	0.288	7.32	72.5	131.0
C0459A**	3	14	19/0147	0.013	0.33	0.042	1.07	0.298	7.57	63.0	113.5
C0460A**	2	12	19/0185	0.013	0.33	0.042	1.07	0.315	8.00	80.5	145.0

\*NEC Type PLTC Only  
 \*\*CSA or c(UL)  
 Data subject to change.

**COLOR CODE CHART**

NO. OF COND.	COLOR
1	Black
2	Red
3	White

# Multi-Conductor, Spiral Shield

UL 2095, NEC Type CL2, NEC/CEC Type CMG UL/CSA\*\*

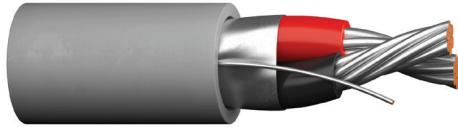

**Product Construction:**

**Conductor:**

- 22 thru 16 AWG fully annealed stranded tinned copper per ASTM B33

**Insulation:**

- Premium-grade, color-coded PVC
- Color code: See charts below

**Shield:**

- 85% spiral tinned copper

**Jacket:**

- PVC, gray
- Temperature range: -20°C to +105°C

**Applications:**

- Electronic circuits where RF shielding is required
- Radio transmitters
- Sound systems
- Recording studios
- Suggested voltage rating: 300 volts

**Compliances:**

- NEC Article 800 Type CM (UL: 105°C)
- UL Style 2095 (UL: 105°C, 300 V)
- CSA CMG (CSA: 105°C)
- RoHS Compliant Directive 2015/863/EU (RoHS-3)
- Passes CSA CMG Flame Test
- NEC Article 725 Type CL2 (UL: 105°C)

**Packaging:**

- Please contact Customer Service for packaging and color options

CATALOG NUMBER	NO. OF COND.	AWG SIZE	COND. STRAND	NOM. INSULATION THICKNESS		NOM. JACKET THICKNESS		NOMINAL O.D.		NOM. CAP.*	
				in	mm	in	mm	in	mm	A	B

**UL STYLE 2095, CM (UL) C(UL), CSA CMG, 300 V**

<b>C2882A</b>	2	22	7/30	0.015	0.38	0.032	0.81	0.197	5.00	40.0	72.0
<b>C2888A</b>	2	20	7/28	0.016	0.41	0.032	0.81	0.215	5.46	44.0	80.2

Color Code Chart #1

**CL2/CM (UL) C(UL), CSA CMG, 300 V**

<b>C1335A</b>	3	22	7/30	0.015	0.38	0.032	0.81	0.206	5.23	37.0	67.0
<b>C1337A</b>	4	22	7/30	0.015	0.38	0.032	0.81	0.222	5.64	37.0	67.0
<b>C1341A</b>	6	22	7/30	0.015	0.38	0.032	0.81	0.257	6.53	34.5	62.0
<b>C2768A</b>	3	18	7/26	0.020	0.51	0.032	0.81	0.266	6.76	41.0	74.0

Color Code Chart #1

**CM (UL) C(UL), CSA CMG, 300 V**

<b>C2892A</b>	2	18	16/30	0.016	0.41	0.032	0.81	0.252	6.40	49.5	89.0
<b>C2895A</b>	2	16	19/0117	0.016	0.41	0.032	0.81	0.265	6.73	58.0	104.0

Color Code Chart #2

\*A – Capacitance between conductors

\*B – Capacitance between one conductor and other conductors connected to shield

\*\*CSA or c(UL)

Data subject to change.

**COLOR CODE CHART 1**

NO. OF COND.	COLOR
1	Black
2	Red
3	White
4	Green
5	Yellow
6	Blue

**COLOR CODE CHART 2**

CATALOG NUMBER	CONDUCTOR	COLOR
<b>C2892A</b>	1	White
	2	Red
<b>C2895A</b>	1	White
	2	Black



# Multi-Conductor, Braid Shield

NEC Type CL2 and CM(UL) c(UL)

**Product Construction:**

**Conductor:**

- 22 AWG fully annealed solid or stranded tinned copper per ASTM B33

**Insulation:**

- Premium-grade, color-coded PVC
- Color code: See chart below

**Shield:**

- 88% tinned copper braid
- Stranded or solid tinned copper drain wire

**Jacket:**

- PVC, black
- Temperature range: -20°C to +105°C

**Applications:**

- Electronic circuits where RF shielding is required
- Radio transmitters
- Sound systems
- Recording studios
- Good flexibility
- Excellent shielding for noise reduction
- Suggested voltage rating: 300 volts

**Compliances:**

- NEC Article 800 Type CM (UL: 105°C)
- RoHS Compliant Directive 2015/863/EU (RoHS-3)
- NEC Article 725 Type CL2 (UL: 105°C)

**Packaging:**

- Please contact Customer Service for packaging and color options

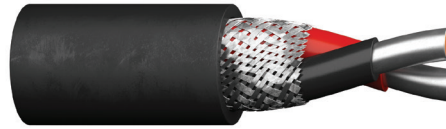

CATALOG NUMBER	NO. OF COND.	AWG SIZE	COND. STRAND	NOM. INSULATION THICKNESS		NOM. JACKET THICKNESS		NOMINAL O.D.		NOM. CAP.* pF/ft	
				in	mm	in	mm	in	mm	A	B
<b>C2676A</b>	2	22	Solid	0.015	0.38	0.032	0.81	0.209	5.31	38.6	69.4
<b>C2677A</b>	2	22	7/30	0.015	0.38	0.032	0.81	0.211	5.36	39.3	70.7

\*A - Capacitance between conductors\*

\*B - Capacitance between one conductor and other conductors connected to shield

Data subject to change.

**COLOR CODE CHART**

NO. OF COND.	COLOR
<b>1</b>	Black
<b>2</b>	Red

# Multi-Conductor, Braid Shield

UL 2092, 2093, 2094, NEC Type CM (UL) c(UL) CMH



**Product Construction:**

**Conductor:**

- 20 AWG fully annealed stranded tinned copper per ASTM B33

**Insulation:**

- Premium-grade, color-coded polyethylene
- Color code: See chart below

**Shield:**

- 80% tinned copper braid
- Mylar wrap under braid

**Jacket:**

- PVC, gray
- Temperature range: -20°C to +75°C

**Applications:**

- Electronic circuits where RF shielding is required
- Video interconnect
- Broadcast and studio
- Sound systems
- Suggested voltage rating: 300 volts

**Compliances:**

- NEC Article 800 Type CM/CMH (UL: 75°C)
- AWM style 2092 (UL: 60°C, 300 V)
- AWM style 2093 (UL: 60°C, 300 V)
- AWM style 2094 (UL: 60°C, 300 V)
- RoHS Compliant Directive 2015/863/EU (RoHS-3)

**Packaging:**

- Please contact Customer Service for packaging and color options

CATALOG NUMBER	NO. OF COND.	AWG SIZE	COND. STRAND	NOM. INSULATION THICKNESS		NOM. JACKET THICKNESS		NOMINAL O.D.		NOM. CAP.*	
				in	mm	in	mm	in	mm	A	B

**AWM STYLE 2092, CM (UL) C(UL) CMH, 300 V**

<b>C1642A</b>	2	20	26/34	0.016	0.38	0.029	0.74	0.226	5.74	24.0	43.0
---------------	---	----	-------	-------	------	-------	------	-------	------	------	------

**AWM STYLE 2093, CM (UL) C(UL) CMH, 300 V**

<b>C1643A</b>	3	20	26/34	0.016	0.38	0.029	0.74	0.236	5.99	22.0	40.0
---------------	---	----	-------	-------	------	-------	------	-------	------	------	------

**AWM STYLE 2094, CM (UL) C(UL) CMH 300 V**

<b>C1644A</b>	4	20	26/34	0.016	0.38	0.029	0.74	0.255	6.48	22.0	39.0
<b>C1645A</b>	5	20	26/34	0.016	0.38	0.029	0.74	0.274	6.96	22.0	39.0
<b>C1646A</b>	6	20	26/34	0.016	0.38	0.029	0.74	0.290	7.37	20.0	36.0

\*A – Capacitance between conductors

\*B – Capacitance between one conductor and other conductors connected to shield  
Data subject to change.

**COLOR CODE CHART**

NO. OF COND.	COLOR
1	Black
2	White
3	Red
4	Green
5	Yellow
6	Blue





# Multi-Conductor, Braid Shield

UL 2095, NEC/CEC Type CMG UL/CSA\*\*

**Product Construction:**

**Conductor:**

- 22 thru 16 AWG fully annealed stranded tinned copper per ASTM B33

**Insulation:**

- Premium-grade, color-coded PVC
- Color code: See chart below

**Shield:**

- 75% tinned copper braid

**Jacket:**

- PVC, gray
- Temperature range: -20°C to +105°C

**Applications:**

- Electronic circuits where RF shielding is required
- Radio transmitters
- Sound systems
- Recording studios
- Provides good flexibility
- Excellent shielding for noise reduction
- Suggested voltage rating: 300 volts

**Compliances:**

- NEC Article 800 Type CM (UL: 105°C)
- UL Style 2095 (UL: 105°C, 300 V)
- RoHS Compliant Directive 2015/863/EU (RoHS-3)
- CSA CMG (CSA: 105°C)
- Passes CSA CMG Flame Test

**Packaging:**

- Please contact Customer Service for packaging and color options

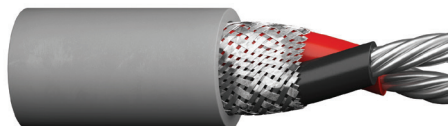

CATALOG NUMBER	NO. OF COND.	AWG SIZE	COND. STRAND	NOM. INSULATION THICKNESS		NOM. JACKET THICKNESS		NOMINAL O.D.		NOM. CAP.*	
				in	mm	in	mm	in	mm	A	B
<b>C2679A</b>	2	22	7/30	0.016	0.41	0.032	0.81	0.212	5.38	40.0	72.0
<b>C2678A</b>	3	22	7/30	0.016	0.41	0.032	0.81	0.221	5.61	37.0	67.0
<b>C2680A</b>	4	22	7/30	0.016	0.41	0.032	0.81	0.237	6.02	37.0	67.0
<b>C2681A</b>	2	20	7/28	0.016	0.41	0.032	0.81	0.230	5.84	44.0	80.0
<b>C1332A</b>	3	20	7/28	0.016	0.41	0.032	0.81	0.240	6.10	40.0	72.0
<b>C2683A</b>	4	20	7/28	0.016	0.41	0.032	0.81	0.259	6.58	40.0	73.0
<b>C2686A</b>	2	18	16/30	0.016	0.41	0.032	0.81	0.252	6.40	49.0	89.0
<b>C2687A</b>	3	18	16/30	0.016	0.41	0.032	0.81	0.264	6.71	45.0	80.5
<b>C2688A</b>	4	18	16/30	0.016	0.41	0.032	0.81	0.286	7.26	45.0	80.5
<b>C2689A</b>	2	16	19/29	0.020	0.51	0.032	0.81	0.280	7.11	51.0	91.0

\*A – Capacitance between conductors

\*B – Capacitance between one conductor and other conductors connected to shield

\*\*CSA or c(UL)

Data subject to change.

**COLOR CODE CHART**

NO. OF COND.	COLOR
<b>1</b>	Black
<b>2</b>	Red
<b>3</b>	White
<b>4</b>	Green



# Multi-Conductor, Foil/Braid Shield

UL 2094, NEC Type CL2

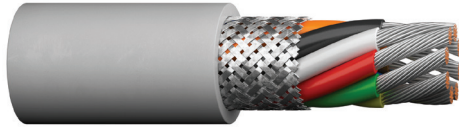

CATALOG NUMBER	NO. OF COND.	AWG SIZE	COND. STRAND	NOM. INSULATION THICKNESS		NOM. JACKET THICKNESS		NOMINAL O.D.		NOM. CAP.*	
				in	mm	in	mm	in	mm	A	B
<b>C1648A</b>	8	20	26/34	0.016	0.38	0.029	0.74	0.316	8.03	20.0	36.0

\*A – Capacitance between conductors

\*B – Capacitance between one conductor and other conductors connected to shield

Data subject to change.

### COLOR CODE CHART

NO. OF COND.	COLOR	NO. OF COND.	COLOR
1	Black	5	Yellow
2	White	6	Blue
3	Red	7	Brown
4	Green	8	Orange

### Product Construction:

#### Conductor:

- 20 AWG fully annealed stranded tinned copper per ASTM B33

#### Insulation:

- Premium-grade, color-coded polyethylene
- Color code: See chart below

#### Shield:

- 100% Flexfoil® aluminum/polyester, 25% overlap, foil facing out
- 80% tinned copper braid

#### Jacket:

- PVC, gray
- Temperature range: -20°C to +75°C

### Applications:

- Electronic circuits where RF shielding is required
- Video interconnect
- Broadcast and studio
- Sound systems
- Suggested voltage rating: 300 volts

### Compliances:

- NEC Article 725 Type CL2 (UL: 75°C)
- UL Style 2094 (UL: 60°C, 300 V)
- RoHS Compliant Directive 2015/863/EU (RoHS-3)

### Packaging:

- Please contact Customer Service for packaging and color options

# Multi-Conductor, Rubber, Unshielded

**Product Construction:**

**Conductor:**

- 20 AWG fully annealed stranded tinned copper per ASTM B33

**Insulation:**

- Premium-grade, color-coded rubber
- Color code: See chart below

**Jacket:**

- Rubber, black
- Temperature range: -20°C to +60°C

**Applications:**

- Energy management systems
- Control circuits
- Fire alarm control
- Broadcast and studio requirements
- Suggested voltage rating: 350 volts

**Features:**

- Excellent impact resistance
- High level of abrasion resistance
- High flexibility
- Excellent mechanical strength
- Excellent moisture resistance

**Compliances:**

- RoHS Compliant Directive 2015/863/EU (RoHS-3)

**Packaging:**

- Please contact Customer Service for packaging and color options



CATALOG NUMBER	NO. OF COND.	AWG SIZE	COND. STRAND	NOM. INSULATION THICKNESS		NOM. JACKET THICKNESS		NOMINAL O.D.	
				in	mm	in	mm	in	mm
<b>C3602</b>	2	20	26/34	0.020	0.51	0.035	0.89	0.016	0.406
<b>C3603</b>	3	20	26/34	0.020	0.51	0.035	0.89	0.016	0.406
<b>C3604</b>	4	20	26/34	0.020	0.51	0.035	0.89	0.016	0.406
<b>C3605</b>	5	20	26/34	0.020	0.51	0.035	0.89	0.016	0.406
<b>C3606</b>	6	20	26/34	0.020	0.51	0.035	0.89	0.016	0.406
<b>C3607</b>	7	20	26/34	0.020	0.51	0.035	0.89	0.016	0.406
<b>C3608</b>	8	20	26/34	0.020	0.51	0.035	0.89	0.016	0.406
<b>C3610</b>	10	20	26/34	0.020	0.51	0.035	0.89	0.016	0.406

Data subject to change.

**COLOR CODE CHART**

NO. OF COND.	COLOR	NO. OF COND.	COLOR	NO. OF COND.	COLOR	NO. OF COND.	COLOR
<b>1</b>	Black	<b>4</b>	Green	<b>7</b>	Yellow	<b>10</b>	Red/Black
<b>2</b>	White	<b>5</b>	Orange	<b>8</b>	Brown		
<b>3</b>	Red	<b>6</b>	Blue	<b>9</b>	White/Black		

# Multi-Conductor, Rubber, Braid Shield



CATALOG NUMBER	NO. OF COND.	AWG SIZE	COND. STRAND	NOM. INSULATION THICKNESS		NOM. JACKET THICKNESS		NOMINAL O.D.	
				in	mm	in	mm	in	mm
<b>C1302</b>	2	20	26/34	0.020	0.51	0.035	0.89	0.270	6.86
<b>C1304</b>	3	20	26/34	0.020	0.51	0.035	0.89	0.285	7.24
<b>C1305</b>	4	20	26/34	0.020	0.51	0.035	0.89	0.300	7.62
<b>C1310</b>	6	20	26/34	0.020	0.51	0.035	0.89	0.340	8.64
<b>C1312</b>	7	20	26/34	0.020	0.51	0.035	0.89	0.355	9.02
<b>C1313</b>	8	20	26/34	0.020	0.51	0.035	0.89	0.385	9.78

Data subject to change.

## COLOR CODE CHART

NO. OF COND.	COLOR	NO. OF COND.	COLOR
<b>1</b>	Black	<b>5</b>	Orange
<b>2</b>	White	<b>6</b>	Blue
<b>3</b>	Red	<b>7</b>	Yellow
<b>4</b>	Green	<b>8</b>	Brown

### Product Construction:

#### Conductor:

- 20 AWG fully annealed stranded tinned copper per ASTM B33

#### Insulation:

- Premium-grade, color-coded rubber
- Color code: See chart below

#### Shield:

- 80% tinned copper braid

#### Jacket:

- Rubber, black
- Temperature range: -20°C to +60°C

### Applications:

- Control circuits
- Broadcast and studio applications
- Audio interconnects
- Suggested voltage rating: 300 volts

### Features:

- Impact- and abrasion-resistant
- Stranded conductors for superior flexibility

### Compliances:

- RoHS Compliant Directive 2015/863/EU (RoHS-3)

### Packaging:

- Please contact Customer Service for packaging and color options

# Multi-Conductor, Carolprene<sup>®</sup>, Braid Shield

**Product Construction:**

**Conductor:**

- 18 thru 14 AWG fully annealed stranded tinned copper per ASTM B33

**Insulation:**

- Premium-grade, color-coded rubber
- Color code: See chart below

**Shield:**

- 80% tinned copper braid

**Jacket:**

- Carolprene<sup>®</sup>, black
- Temperature range: -20°C to +60°C

**Applications:**

- Control circuits
- Broadcast and studio applications
- Audio interconnects
- Suggested voltage rating: 300 volts

**Features:**

- Impact- and abrasion-resistant
- Stranded conductors for superior flexibility

**Compliance:**

- RoHS Compliant Directive 2015/863/EU (RoHS-3)

**Packaging:**

- Please contact Customer Service for packaging and color options



CATALOG NUMBER	NO. OF COND.	AWG SIZE	COND. STRAND	NOM. INSULATION THICKNESS		NOM. JACKET THICKNESS		NOMINAL O.D.	
				in	mm	in	mm	in	mm
C1202	2	18	41/34	0.020	0.51	0.035	0.89	0.295	7.49
C1203	3	18	41/34	0.020	0.51	0.035	0.89	0.305	7.75
C1206	6	18	41/34	0.020	0.51	0.035	0.89	0.370	9.39
C1602	2	16	65/34	0.025	0.64	0.035	0.89	0.335	8.51
C1603	3	16	65/34	0.025	0.64	0.035	0.89	0.355	9.02
C1604	4	16	65/34	0.025	0.64	0.035	0.89	0.385	9.78

Data subject to change.

**COLOR CODE CHART**

NO. OF COND.	COLOR
1	Black
2	White
3	Red
4	Green
5	Blue
6	Brown

**Notes:**

# Communication & Control Cable, Multi-Paired 2

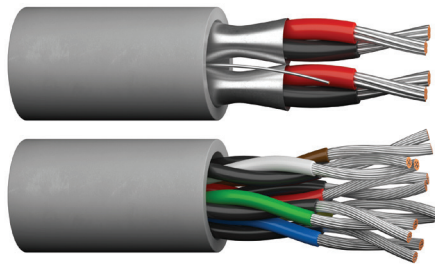

In many electronic applications, two wires are required to complete circuits; these are often referred to as “balanced arrays” or “twisted pair” constructions.

Paired cable designs find frequent application in circuits requiring circuit-to-circuit isolation from noise, minimization of capacitance imbalances and a reduction of EMI interference currents.

Circuit separation is further enhanced in those designs employing individual circuit shields in concert with an overall shield. These shielding systems are available from Prysmian in myriad combinations to suit the unique needs of the circuit designer.

As with the multi-conductor designs, a wide array of insulating and jacketing materials are available to meet specific electronic applications.

Prysmian’s CAROL® Brand communication cable products are manufactured to meet the latest UL, CSA and NEC requirements and approvals.

Index	Page
Multi-Paired, Unshielded	34-35
Multi-Paired, Foil Shield	36-39
Multi-Paired, Individually Shielded (UL)	40
Multi-Paired, Individually Shielded (CSA)	41
Power-Limited Tray Cable, Individually Shielded	42
Power-Limited Tray Cable, Foil Shield	43

# Multi-Paired, Unshielded

UL 2464, NEC/CEC Type CMG UL/CSA\*\*

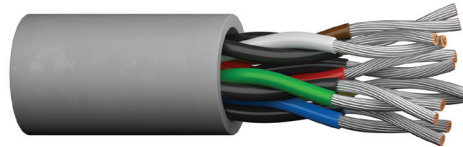

**Product Construction:**

**Conductor:**

- 22 AWG fully annealed solid or stranded tinned copper per ASTM B33
- Twisted pairs

**Insulation:**

- Premium-grade, color-coded PVC
- Color code: See chart below

**Jacket:**

- PVC, gray
- Temperature range: -20°C to +105°C

**Applications:**

- Computers
- Industrial equipment
- Data transmission
- Control circuits
- Suitable for EIA RS-232 applications
- Suggested voltage rating: 300 volts

**Compliances:**

- NEC Article 800 Type CM (UL: 105°C)
- UL Style 2464 (UL: 80°C, 300 V)
- CSA CMG (CSA: 105°C)
- RoHS Compliant Directive 2015/863/EU (RoHS-3)
- Passes CSA CMG Flame Test

**Packaging:**

- Please contact Customer Service for packaging and color options

CATALOG NUMBER	NO. OF PAIRS	AWG SIZE	COND. STRAND	NOM. INSULATION THICKNESS		NOM. JACKET THICKNESS		NOMINAL O.D.		NOM. C-C CAP.* pF/ft
				in	mm	in	mm	in	mm	
C4008A	1	22	Solid	0.010	0.25	0.032	0.81	0.156	3.94	24.5
C4010A	2	22	Solid	0.010	0.25	0.032	0.81	0.218	5.54	24.5
C4014A	3	22	Solid	0.010	0.25	0.032	0.81	0.229	5.82	24.5
C4015A	4	22	Solid	0.010	0.25	0.032	0.81	0.249	6.32	24.5
C4017A	6	22	Solid	0.010	0.30	0.032	0.81	0.288	7.44	24.5
C6010A	2	22	7/30	0.010	0.25	0.032	0.81	0.228	5.79	24.5
C6014A	3	22	7/30	0.010	0.25	0.032	0.81	0.240	6.10	24.5
C6015A	4	22	7/30	0.010	0.25	0.032	0.81	0.262	6.65	24.5
C6017A	6	22	7/30	0.010	0.25	0.032	0.81	0.300	7.62	24.5
C6019A	9	22	7/30	0.010	0.25	0.032	0.81	0.366	9.30	24.5
C6023A	12	22	7/30	0.010	0.25	0.032	0.81	0.410	10.40	24.5
C6026A	15	22	7/30	0.010	0.25	0.032	0.81	0.456	11.58	24.5

\* Capacitance between conductors

\*\*CSA or c(UL)

Data subject to change.

**COLOR CODE CHART**

NO. OF PAIRS	COLOR	NO. OF PAIRS	COLOR	NO. OF PAIRS	COLOR
1	Black paired with Red	6	Black paired with Brown	11	Red paired with Yellow
2	Black paired with White	7	Black paired with Orange	12	Red paired with Brown
3	Black paired with Green	8	Red paired with White	13	Red paired with Orange
4	Black paired with Blue	9	Red paired with Green	14	Green paired with White
5	Black paired with Yellow	10	Red paired with Blue	15	Green paired with Blue





# Multi-Paired, Unshielded

UL 2464, NEC/CEC Type CMG UL/CSA\*\*

**Product Construction:**

**Conductor:**

- 18 AWG fully annealed stranded tinned copper per ASTM B33
- Twisted pairs

**Insulation:**

- Premium-grade, color-coded PVC
- Color code: See chart below

**Jacket:**

- PVC, gray
- Temperature range: -20°C to +105°C

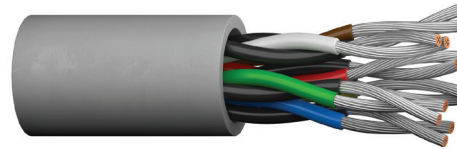

**Applications:**

- Computers
- Industrial equipment
- Data transmission
- Control circuits
- Suitable for EIA RS-232 applications
- Suggested voltage rating: 300 volts

**Compliances:**

- NEC Article 800 Type CM (UL: 105°C)
- UL Style 2464 (UL: 105°C, 300 V)
- CSA CMG (CSA: 105°C)
- RoHS Compliant Directive 2015/863/EU (RoHS-3)
- Passes CSA CMG Flame Test

**Packaging:**

- Please contact Customer Service for packaging and color options

CATALOG NUMBER	NO. OF PAIRS	AWG SIZE	COND. STRAND	NOM. INSULATION THICKNESS		NOM. JACKET THICKNESS		NOMINAL O.D.		NOM. C-C CAP.* pF/ft
				in	mm	in	mm	in	mm	
C6101A	1	18	16/30	0.013	0.33	0.032	0.81	0.206	5.23	26.3
C6118A	2	18	16/30	0.013	0.33	0.032	0.81	0.320	8.13	26.3
C6103A	3	18	16/30	0.013	0.33	0.032	0.81	0.338	8.59	26.3
C6119A	4	18	16/30	0.013	0.33	0.032	0.81	0.372	9.45	26.3
C6120A	5	18	16/30	0.013	0.33	0.032	0.81	0.408	10.36	26.3
C6106A	6	18	16/30	0.013	0.33	0.032	0.81	0.445	11.30	26.3
C6121A	8	18	16/30	0.013	0.33	0.032	0.81	0.484	12.29	26.3
C6109A	9	18	16/30	0.013	0.33	0.032	0.81	0.522	13.26	26.3
C6111A	15	18	16/30	0.013	0.33	0.032	0.81	0.659	16.74	26.3

\*Capacitance between conductors

\*\*CSA or c(UL)

Data subject to change.

**COLOR CODE CHART**

NO. OF PAIRS	COLOR	NO. OF PAIRS	COLOR	NO. OF PAIRS	COLOR
1	Black paired with Red	6	Black paired with Brown	11	Red paired with Yellow
2	Black paired with White	7	Black paired with Orange	12	Red paired with Brown
3	Black paired with Green	8	Red paired with White	13	Red paired with Orange
4	Black paired with Blue	9	Red paired with Green	14	Green paired with White
5	Black paired with Yellow	10	Red paired with Blue	15	Green paired with Blue

# Multi-Paired, Foil Shield

NEC/CEC Type CMG UL/CSA\*\*



**Product Construction:**

**Conductor:**

- 22 AWG fully annealed solid or stranded tinned copper per ASTM B33
- Twisted pairs

**Insulation:**

- Premium-grade, color-coded PVC
- Color code: See chart below

**Shield:**

- 100% Flexfoil® aluminum/polyester, 25% overlap, foil facing out
- Stranded tinned copper drain wire

**Jacket:**

- PVC, gray
- Temperature range: -20°C to +105°C

**Applications:**

- Audio systems
- Communication circuits
- Instrumentation and control use
- Suggested voltage rating: 300 volts

**Compliances:**

- NEC Article 800 Type CM (UL: 105°C, 300 V)
- CSA CMG (CSA: 105°C)
- RoHS Compliant Directive 2015/863/EU (RoHS-3)
- Passes CSA CMG Flame Test

**Packaging:**

- Please contact Customer Service for packaging and color options

CATALOG NUMBER	NO. OF PAIRS	AWG SIZE	COND. STRAND	NOM. INSULATION THICKNESS		NOM. JACKET THICKNESS		NOMINAL O.D.		NOMINAL CAP.* pF/ft	
				in	mm	in	mm	in	mm	A	B
<b>C7104A</b> †	1	22	7/0096	0.013	0.33	0.035	0.89	0.185	4.70	35.0	62.0
<b>C1670A</b>	2	22	Solid	0.010	0.25	0.032	0.81	0.218	5.54	32.0	57.0
<b>C1676A</b>	4	22	Solid	0.010	0.25	0.032	0.81	0.249	6.32	28.0	50.0
<b>C1671A</b>	6	22	Solid	0.010	0.25	0.032	0.81	0.292	7.42	25.0	45.0
<b>C1672A</b>	9	22	Solid	0.010	0.25	0.032	0.81	0.338	8.59	25.0	45.0
<b>C1673A</b>	15	22	Solid	0.010	0.25	0.032	0.81	0.419	10.64	25.0	45.0

\*A – Capacitance between conductors

\*B – Capacitance between one conductor and other conductors connected to shield

† Also UL Style 2464 (UL: 80°C, 300 V)

\*\*CSA or c(UL)

Data subject to change.

**COLOR CODE CHART**

NO. OF PAIRS	COLOR	NO. OF PAIRS	COLOR	NO. OF PAIRS	COLOR
<b>1</b>	Black paired with Red	<b>6</b>	Black paired with Brown	<b>11</b>	Red paired with Yellow
<b>2</b>	Black paired with White	<b>7</b>	Black paired with Orange	<b>12</b>	Red paired with Brown
<b>3</b>	Black paired with Green	<b>8</b>	Red paired with White	<b>13</b>	Red paired with Orange
<b>4</b>	Black paired with Blue	<b>9</b>	Red paired with Green	<b>14</b>	Green paired with White
<b>5</b>	Black paired with Yellow	<b>10</b>	Red paired with Blue	<b>15</b>	Green paired with Blue

# Multi-Paired, Foil Shield

NEC Type CMP (UL) c(UL)

**Product Construction:**

**Conductor:**

- 22 and 24 AWG fully annealed stranded tinned copper per ASTM B33
- Twisted pairs

**Insulation:**

- Premium-grade, color-coded fluoropolymer
- Color code: See chart below

**Shield:**

- 100% Flexfoil® aluminum/polyester foil with 25% overlap, minimum
- Stranded tinned copper drain wire

**Jacket:**

- Fluoropolymer, natural
- Water-resistant
- Temperature range: -40°C to +150°C
- Sequential footage marked to facilitate installation
- Includes ripcord

**Applications:**

- EIA RS-232 circuits
- Remote control circuits
- Process control and instrumentation
- Power-limited control circuits
- Suggested voltage rating: 300 volts

**Compliances:**

- NEC Article 800 (UL: 150°C, 300 V)
- Designed to meet NFPA 262 and CSA FT6 Steiner Tunnel Fire Tests for Plenum Applications

**Packaging:**

- Please contact Customer Service for packaging and color options

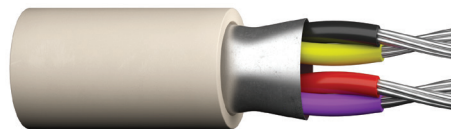

CATALOG NUMBER	NO. OF PAIRS	AWG SIZE	COND. STRAND	NOM. INSULATION THICKNESS		NOM. JACKET THICKNESS		NOMINAL O.D.		NOM. CAP.* pF/ft	
				in	mm	in	mm	in	mm	A	B
<b>C3204</b>	1	22	7/30	0.006	0.15	0.010	0.25	0.117	2.97	31.0	55.8
<b>C3205</b>	2	22	7/30	0.006	0.15	0.010	0.25	0.151	3.84	25.0	45.0
<b>C3206</b>	3	22	7/30	0.006	0.15	0.010	0.25	0.177	4.50	25.0	36.0
<b>C3207</b>	4	22	7/30	0.006	0.15	0.010	0.25	0.200	5.08	20.0	45.0
<b>C3208</b>	6	22	7/30	0.006	0.15	0.010	0.25	0.237	6.02	18.0	32.4
<b>C3150</b>	2	24	7/32	0.006	0.15	0.010	0.25	0.130	3.30	22.0	39.6
<b>C3153</b>	3	24	7/32	0.006	0.15	0.010	0.25	0.152	3.86	18.0	32.4
<b>C3151</b>	4	24	7/32	0.006	0.15	0.010	0.25	0.170	4.32	17.0	30.6
<b>C3165</b>	6	24	7/32	0.006	0.15	0.010	0.25	0.200	5.08	17.0	30.6
<b>C3152</b>	12.5	24	7/32	0.006	0.15	0.012	0.30	0.290	7.04	17.0	30.6

\*A – Capacitance between conductors

\*B – Capacitance between one conductor and other conductors connected to shield

Data subject to change.

**COLOR CODE CHART**

NO. OF PAIRS	COLOR	NO. OF PAIRS	COLOR	NO. OF PAIRS	COLOR
<b>1</b>	Black & Yellow	<b>6</b>	Tan & White	<b>11</b>	Gray/White & White/Gray
<b>2</b>	Red & Purple	<b>7</b>	Light Blue & Light Green	<b>12</b>	Blue/White & White/Blue
<b>3</b>	Dark Blue & Brown	<b>8</b>	Red/White & White/Red	<b>1C</b>	Dark Green/Yellow
<b>4</b>	Orange & Dark Green	<b>9</b>	Orange/White & White/Orange		
<b>5</b>	Pink & Gray	<b>10</b>	Yellow/White & White/Yellow		



# Multi-Paired, Foil Shield

AWM Style 2464, CSA Type AWM I/II A/B, NEC/CEC Type CMG (CSA C/US)

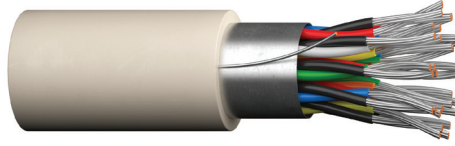

CATALOG NUMBER	NO. OF PAIRS	AWG SIZE	COND. STRAND	NOM. INSULATION THICKNESS		NOM. JACKET THICKNESS		NOMINAL O.D.		NOMINAL DCR Ω/KFT		COLOR CODE	NOM. CAP.*	
				in	mm	in	mm	in	mm	COND.	SHLD.		A	B
C4170A	1	24	7/32	0.011	0.28	0.032	0.81	0.160	4.06	26.0	18.0	1	36.4	65.5
C4209A	1	24	7/32	0.011	0.28	0.032	0.81	0.160	4.06	26.0	18.0	Wht/Blk	36.4	65.5
C4191A	1	24	7/32	0.011	0.28	0.030	0.76	0.160	4.06	26.0	16.5	Blk/Red	43.0	78.0
C4171A	2	24	7/32	0.011	0.28	0.032	0.81	0.214	5.44	26.0	18.0	1	31.9	57.3
C4172A	3	24	7/32	0.011	0.28	0.032	0.81	0.225	5.72	26.0	16.5	1	28.6	51.4
C4173A	4	24	7/32	0.011	0.28	0.032	0.81	0.245	6.22	26.0	16.5	1	28.6	51.4
C4174A	5	24	7/32	0.011	0.28	0.032	0.81	0.275	6.99	26.0	16.5	1	28.6	51.4
C4175A	6	24	7/32	0.011	0.28	0.032	0.81	0.300	7.62	26.0	15.2	1	26.3	47.5
C4176A	7	24	7/32	0.011	0.28	0.032	0.81	0.300	7.62	26.0	15.2	1	26.3	47.5
C4177A	8	24	7/32	0.011	0.28	0.032	0.81	0.320	8.13	26.0	15.0	1	26.3	47.5
C4178A	9	24	7/32	0.011	0.28	0.032	0.81	0.345	8.76	26.0	15.0	1	26.3	47.5
C4179A	10	24	7/32	0.011	0.28	0.032	0.81	0.375	9.53	26.0	14.0	1	26.3	47.5
C4180A	15	24	7/32	0.011	0.28	0.032	0.81	0.428	10.87	26.0	13.8	1	26.3	47.5
C4181A	19	24	7/32	0.011	0.28	0.032	0.81	0.450	11.43	26.0	13.5	1	26.3	47.5
C4182A	25	24	7/32	0.011	0.28	0.032	0.81	0.530	13.46	26.0	12.7	1	26.3	47.5

\*A - Capacitance between conductors  
 \*B - Capacitance between one conductor and other conductors connected to shield  
 Data subject to change.

**Product Construction:**

**Conductor:**

- 24 AWG fully annealed stranded tinned copper per ASTM B33
- Twisted pairs

**Insulation:**

- Premium-grade, color-coded PVC
- Color code: See chart below

**Shield:**

- 100% Flexfoil® aluminum/polyester, 25% overlap, foil facing out
- Stranded tinned copper drain wire

**Jacket:**

- PVC, gray
- Temperature range: -20°C to +105°C

**Applications:**

- Computers
- Industrial equipment
- Data transmission
- Control circuits
- Suitable for EIA RS-232 applications
- Suggested voltage rating: 300 or 600 volts

**Features:**

- Excellent electrical properties
- Superior shielding effectiveness
- 25% shield overlap provides excellent shielding efficiency
- Assists system designers in meeting FCC Docket 20780 demands
- Good flexibility

**Compliances:**

- AWM Style 2464 (UL: 80°C, 300 V)
- CSA Type AWM (105°C, 600 V)
- CSA Certified CMG to harmonized standard UL 444 and CSA 22.2 No. 214
- NEC/CEC Type CMG (CSA: 105°C, 300 V)
- RoHS Compliant Directive 2015/863/EU (RoHS-3)
- Passes CSA FT4 Vertical Flame Test

**Packaging:**

- Please contact Customer Service for packaging and color options

**COLOR CODE CHART 1**

NO. OF COND.	COLOR	NO. OF COND.	COLOR	NO. OF COND.	COLOR	NO. OF COND.	COLOR	NO. OF COND.	COLOR
1	Black with Red	6	Black with Brown	11	Red with Yellow	16	Green with Yellow	21	White with Brown
2	Black with White	7	Black with Orange	12	Red with Brown	17	Green with Brown	22	White with Orange
3	Black with Green	8	Red with White	13	Red with Orange	18	Green with Orange	23	Blue with Yellow
4	Black with Blue	9	Red with Green	14	Green with White	19	White with Blue	24	Blue with Brown
5	Black with Yellow	10	Red with Blue	15	Green with Blue	20	White with Yellow	25	Blue with Orange

# Multi-Paired, Foil Shield

AWM Style 2464, CSA Type AWM I/II A/B, NEC/CEC Type CMG (CSA C/US)

**Product Construction:**

**Conductor:**

- 22 AWG fully annealed stranded tinned copper per ASTM B33
- Twisted pairs

**Insulation:**

- Premium-grade, color-coded PVC
- Color code: See chart below

**Shield:**

- 100% Flexfoil® aluminum/polyester, 25% overlap, foil facing out
- Stranded tinned copper drain wire

**Jacket:**

- PVC, gray
- Temperature range: -20°C to +105°C

**Applications:**

- Computers
- Industrial equipment
- Data transmission
- Control circuits
- Suitable for EIA RS-232 applications
- Suggested voltage ratings: 300 or 600 volts

**Features:**

- Excellent electrical properties
- Superior shielding effectiveness
- 25% shield overlap provides excellent shielding efficiency
- Assists system designers in meeting FCC Docket 20780 demands
- Good flexibility

**Compliances:**

- AWM Style 2464 (UL: 80°C, 300 V)
- CSA Type AWM (105°C, 600 V)
- CSA Certified CMG to harmonized standard UL 444 and CSA 22.2 No. 214
- NEC/CEC Type CMG (CSA: 105°C, 300 V)
- RoHS Compliant Directive 2015/863/EU (RoHS-3)
- Passes CSA FT4 Vertical Flame Test

**Packaging:**

- Please contact Customer Service for packaging and color options

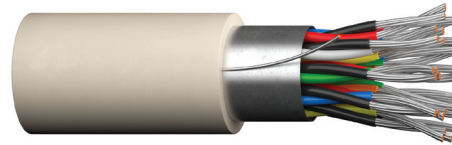

CATALOG NUMBER	NO. OF PAIRS	AWG SIZE	COND. STRAND	NOMINAL INSULATION THICKNESS		NOMINAL JACKET THICKNESS		NOMINAL O.D.		NOMINAL DCR Ω/1000ft		NOMINAL CAP.* pF/ft	
				in	mm	in	mm	in	mm	COND.	SHLD.	A	B
<b>C4183A</b>	1	22	7/30	0.011	0.28	0.032	0.81	0.169	4.29	15.0	18.0	44.8	80.7
<b>C4184A</b>	2	22	7/30	0.011	0.28	0.032	0.81	0.234	5.94	15.0	16.5	35.9	64.6
<b>C4185A</b>	3	22	7/30	0.011	0.28	0.032	0.81	0.246	6.25	15.0	16.5	30.9	55.7
<b>C4186A</b>	4	22	7/30	0.011	0.28	0.032	0.81	0.269	6.83	15.0	16.5	30.9	55.7
<b>C4187A</b>	5	22	7/30	0.011	0.28	0.032	0.81	0.294	7.47	15.0	16.5	30.9	55.7
<b>C4188A</b>	6	22	7/30	0.011	0.28	0.032	0.81	0.320	8.13	15.0	16.5	28.4	51.0
<b>C4189A</b>	9	22	7/30	0.011	0.28	0.032	0.81	0.367	9.32	15.0	16.5	28.4	51.0
<b>C4190A</b>	15	22	7/30	0.011	0.28	0.032	0.81	0.457	11.61	15.0	16.5	28.4	51.0

\*A – Capacitance between conductors

\*B – Capacitance between one conductor and other conductors connected to shield  
Data subject to change.

**COLOR CODE CHART 1**

NO. OF PAIRS	COLOR	NO. OF PAIRS	COLOR	NO. OF PAIRS	COLOR
<b>1</b>	Black paired with Red	<b>6</b>	Black paired with Brown	<b>11</b>	Red paired with Yellow
<b>2</b>	Black paired with White	<b>7</b>	Black paired with Orange	<b>12</b>	Red paired with Brown
<b>3</b>	Black paired with Green	<b>8</b>	Red paired with White	<b>13</b>	Red paired with Orange
<b>4</b>	Black paired with Blue	<b>9</b>	Red paired with Green	<b>14</b>	Green paired with White
<b>5</b>	Black paired with Yellow	<b>10</b>	Red paired with Blue	<b>15</b>	Green paired with Blue

# Multi-Paired, Individually Shielded

UL 2717, UL 2835, NEC Type CM (UL) c(UL) CMH or CMG

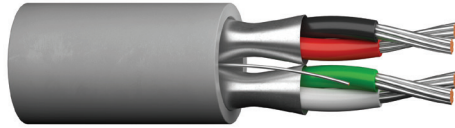

CATALOG NUMBER	NO. OF PAIRS	AWG SIZE	COND. STRAND	NOM. INSULATION THICKNESS		NOM. JACKET THICKNESS		NOMINAL O.D.		NOMINAL CAP.*	
				in	mm	in	mm	in	mm	A	B
<b>POLYPROPYLENE INSULATION – NEC TYPE CM(UL) C(UL) CMH</b>											
<b>C1352A</b>	2	22	7/30	0.007	0.18	0.020	0.51	0.160	4.06	30.0	45.0
<b>POLYPROPYLENE INSULATION – UL STYLE 2717, UL STYLE 2835, CM(UL) C(UL) CMH</b>											
<b>C1353A**</b>	2	22	7/30	0.010	0.25	0.028	0.71	0.208	5.028	25.0	53.5
<b>105°C PVC INSULATION – UL STYLE 2464, CM(UL) C(UL) CMG</b>											
<b>C7106A</b>	2	20	7/28	0.010	0.25	0.041	1.04	0.305	7.75	46.0	82.0

\*A – Capacitance between conductors  
 \*B – Capacitance between one conductor and other conductors connected to shield  
 \*\*Individually shielded with overall shield  
 Data subject to change.

### COLOR CODE CHART

NO. OF PAIRS	COLOR
<b>1</b>	Black/Red
<b>2</b>	Green/White

### Product Construction:

#### Conductor:

- 22 AWG fully annealed stranded tinned copper per ASTM B33
- Twisted pairs

#### Insulation:

- Premium-grade, color-coded polypropylene
- Color code: See chart below

#### Shield:

- Individually shielded pairs
- 100% Flexfoil® aluminum/polyester, 25% overlap, foil facing out
- Stranded tinned copper drain wire

#### Jacket:

- PVC, gray
- Temperature range: -20°C to +80°C

### Applications:

- Where total isolation of signal is required
- Computers
- Control circuits
- Industrial equipment
- Suggested voltage rating: 300 volts

### Compliances:

- NEC Article 800 Type CM (UL: 75°C, 300 V)
- UL Style 2717 (UL: 80°C)
- UL Style 2835 (UL: 60°C, 30 V)
- UL Style 2464 (UL: 80°C, 300 V)
- RoHS Compliant Directive 2015/863/EU (RoHS-3)
- Passes CSA CMH or CMG Flame Test

### Packaging:

- Please contact Customer Service for packaging and color options

# Multi-Paired, Individually Shielded

CSA Type AWM I/II A/B, NEC/CEC Type CMG (CSA C/US)

**Product Construction:**

**Conductor:**

- 22 AWG fully annealed stranded tinned copper per ASTM B33
- Twisted pairs

**Insulation:**

- Premium-grade, color-coded PVC
- Color code: See chart below

**Shield:**

- Individually shielded pairs
- 100% Flexfoil® aluminum/polyester, 25% overlap, foil facing out
- Stranded tinned copper drain wire

**Jacket:**

- PVC, gray
- Temperature range: -20°C to +105°C

**Applications:**

- Where total isolation of signal is required
- Computers
- Control circuits
- Industrial equipment
- Suggested voltage rating: 300 or 600 volts

**Compliances:**

- CSA Type AWM (105°C, 600 V)
- CSA Certified CMG to harmonized standard UL 444 and CSA (22.2 No. 2)
- NEC/CEC Type CMG (CSA: 105°C, 300 V)
- RoHS Compliant Directive 2015/863/EU (RoHS-3)
- Passes CSA FT4 Vertical Flame Test

**Packaging:**

- Please contact Customer Service for packaging and color options

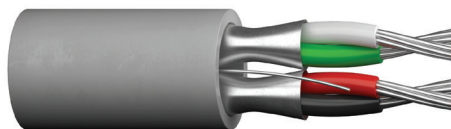

CATALOG NUMBER	NO. OF PAIRS	AWG SIZE	COND. STRAND	NOMINAL INSULATION THICKNESS		NOMINAL JACKET THICKNESS		NOMINAL O.D.		NOMINAL DCR Ω/kft		NOMINAL CAP.* pF/ft	
				in	mm	in	mm	in	mm	COND.	SHLD.	A	B
<b>C4203A</b>	2	22	7/30	0.011	0.28	0.020	0.51	0.175	4.45	16.6	7.2	67.0	121.0

\*A - Capacitance between conductors

\*B - Capacitance between one conductor and other conductors connected to shield

Data subject to change.

**COLOR CODE CHART**

NO. OF PAIRS	COLOR
1	Black with Red
2	Green with White

# Power-Limited Tray Cable, Individually Shielded

UL 2464, NEC Type PLTC and NEC/CEC Type CMG UL/CSA†



**Product Construction:**

**Conductor:**

- 22 or 18 AWG fully annealed stranded tinned copper per ASTM B33
- Twisted pairs

**Insulation:**

- Premium-grade, color-coded PVC
- Color code: Each pair black and red, numbered at one-inch intervals

**Shield:**

- Pairs are 100% individually shielded with Flexfoil® aluminum/polyester, foil facing in
- Stranded tinned copper drain wire each pair

**Jacket:**

- PVC, gray
- Sunlight-resistant
- Temperature range: -20°C to +105°C

**Applications:**

- Power-limited circuits
- Intercom systems
- Business machines
- Cash registers
- Computer interconnects
- Suitably marked for appropriate tray cable installations
- Burglar alarms
- Suggested voltage rating: 300 volts

**Compliances:**

- NEC Article 725 Power-Limited Tray Cable (UL: 105°C, 300 V)
- UL Style 2464 (UL: 80°C)
- CSA CMG (CSA: 105°C)
- RoHS Compliant Directive 2015/863/EU (RoHS-3)
- Passes CSA CMG Flame Test

**Packaging:**

- Please contact Customer Service for packaging and color options

CATALOG NUMBER	NO. OF PAIRS	AWG SIZE	COND. STRAND	NOM. INSULATION THICKNESS		NOM. JACKET THICKNESS		NOMINAL O.D.		NOMINAL CAP.* pF/ft	
				in	mm	in	mm	in	mm	A	B
C0570A	2	22	7/30	0.016	0.41	0.042	1.07	0.327	8.31	38.5	69.5
C0571A	3	22	7/30	0.016	0.41	0.042	1.07	0.345	8.76	38.5	69.5
C0572A	4	22	7/30	0.016	0.41	0.042	1.07	0.378	9.60	38.5	69.5
C0573A	6	22	7/30	0.016	0.41	0.053	1.35	0.469	11.91	38.5	69.5
C0574A	9	22	7/30	0.016	0.41	0.053	1.35	0.542	13.77	38.5	69.5
C0575A	11	22	7/30	0.016	0.41	0.053	1.35	0.589	14.96	38.5	69.5
C0584A	2	18	16/30	0.016	0.41	0.042	1.07	0.380	9.65	50.5	91.0
C0585A	3	18	16/30	0.016	0.41	0.053	1.35	0.437	11.10	50.5	91.0
C0586A	4	18	16/30	0.016	0.41	0.053	1.35	0.478	12.14	50.5	91.0
C0587A	6	18	16/30	0.016	0.41	0.053	1.35	0.566	14.38	50.5	91.0
C0588A	9	18	16/30	0.016	0.41	0.063	1.60	0.679	17.25	50.5	91.0
C0589A	11	18	16/30	0.016	0.41	0.063	1.60	0.738	18.75	50.5	91.0
C0590A	15	18	16/30	0.016	0.41	0.063	1.60	0.845	21.46	50.5	91.0

\*A – Capacitance between conductors

\*B – Capacitance between one conductor and other conductors connected to shield

†CSA or c(UL)

Data subject to change.

**COLOR CODE CHART**

NO. OF PAIRS	COLOR
1 thru 15	Black/Red

Each pair marked and numbered



# Power-Limited Tray Cable, Foil Shield

UL 2464, NEC Type PLTC, NEC/CEC Type CM, CMG UL/CSA†

**Product Construction:**

**Conductor:**

- 22 or 18 AWG fully annealed stranded tinned copper per ASTM B33
- Twisted pairs

**Insulation:**

- Premium-grade, color-coded PVC or FMPE
- Color code: See chart below

**Shield:**

- 100% Flexfoil® aluminum/polyester, 25% overlap, foil facing out
- Stranded tinned copper drain wire
- 65% tinned copper braid (C7112A, C7114A and C7116A only)

**Jacket:**

- PVC, gray or black
- Sunlight-resistant
- Temperature range: -20°C to +60°C or +105°C

**Applications:**

- Power-limited circuits
- Intercom systems
- Business machines
- Computer interconnects
- Suitably marked for appropriate tray cable installations
- Petrochemical control systems
- Burglar alarms
- Suggested voltage rating: 300 volts

**Compliances:**

- NEC Article 725 Power-Limited Tray Cable (UL: 105°C or 60°C, 300 V)
- NEC Article 800 Communications Cable (UL: 105°C or 60°C, 300 V)
- †UL Style 2464 (UL: 80°C, 300 V)
- UL PTLC Listing
- CSA CMG (CSA: 60°C) or CM c(UL)
- RoHS Compliant Directive 2015/863/EU (RoHS-3)
- Passes CSA CMG Flame Test

**Packaging:**

- Please contact Customer Service for packaging and color options
- † UL Style 2464 only available on PVC insulation constructions

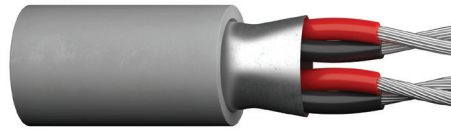

CATALOG NUMBER	NO. OF PAIRS	AWG SIZE	COND. STRAND	NOM. INSULATION THICKNESS		NOM. JACKET THICKNESS		NOMINAL O.D.		NOMINAL CAP.* pF/ft	
				in	mm	in	mm	in	mm	A	B

**PVC INSULATION – UL STYLE 2464, NEC TYPE PLTC/CM, CSA CMG, 105°C**

C0550A	2	22	7/0096	0.015	0.38	0.042	1.07	0.294	7.47	32.0	57.0
C0551A	3	22	7/0096	0.015	0.38	0.042	1.07	0.309	7.85	29.0	52.2
C0552A	4	22	7/0096	0.015	0.38	0.042	1.07	0.337	8.56	29.0	52.2
C0553A	6	22	7/0096	0.015	0.38	0.042	1.35	0.418	10.62	26.5	47.7
C0554A	9	22	7/0096	0.015	0.38	0.042	1.35	0.480	12.19	26.5	47.7
C0555A	11	22	7/30	0.015	0.38	0.053	1.35	0.520	13.21	27.0	48.5
C0556A	15	22	7/30	0.015	0.38	0.053	1.35	0.592	15.04	27.0	48.5
C0560A	2	18	16/30	0.016	0.41	0.042	1.07	0.314	7.98	40.0	72.0
C0561A	3	18	16/30	0.016	0.41	0.042	1.07	0.403	10.24	33.5	60.3
C0562A	4	18	16/30	0.016	0.41	0.042	1.07	0.440	11.18	33.5	60.3
C0563A	6	18	16/30	0.016	0.41	0.053	1.35	0.519	13.18	30.5	54.9
C0564A	9	18	16/30	0.016	0.41	0.063	1.60	0.643	16.33	30.5	54.9
C0566A	15	18	16/30	0.016	0.41	0.063	1.60	0.720	18.29	30.5	54.9

\*A – Capacitance between conductors

\*B – Capacitance between one conductor and other conductors connected to shield

†CSA or c(UL)

Data subject to change.

**COLOR CODE CHART**

NO. OF PAIRS	COLOR
1 thru 15	Black/Red

Each pair marked and numbered



**LO-CAP® DATACOM COLOR CODE WITH 65% TINNED COPPER BRAID**

CATALOG NUMBER	NO. OF PAIRS	AWG SIZE	COND. STRAND	NOM. INSULATION THICKNESS		NOM. JACKET THICKNESS		NOMINAL O.D.		NOMINAL CAP.* pF/ft	
				in	mm	in	mm	in	mm	A	B

**FOAMED POLYETHYLENE INSULATION – NEC TYPE PLTC/CM, CEC CM c(UL), 60°C**

C7112A	1	22	7/0096	0.024	0.61	0.037	0.94	0.261	6.63	11.5	20.5
C7114A	2	22	7/0096	0.017	0.43	0.042	1.07	0.343	8.71	11.0	19.6
C7116A	3	22	7/0096	0.015	0.38	0.042	1.07	0.344	8.74	11.0	19.6

\*A – Capacitance between conductors

\*B – Capacitance between one conductor and other conductors connected to shield

Data subject to change.

**COLOR CODE CHART**

NO. OF PAIRS	COLOR
1	White/Blue Stripe and Blue/White Stripe
2	White/Orange Stripe and Orange/White Stripe
3	White/Green Stripe and Green/White Stripe



Underwriters Laboratories Inc.



# Computer Cable

# 3

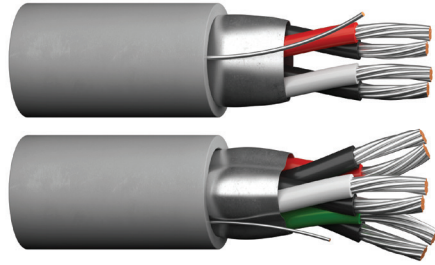

Prysmian manufactures a comprehensive line of computer cables.

This complete line of paired and unpaired, shielded computer cables—which are UL and CSA listed—are used primarily for the internal or external interconnection of electronic equipment and computers. Applications include data transmission, CAD/CAM, telemetry, data displays, computer print-out, credit verification systems and similar applications.

Prysmian also offers a variety of put-ups for computer cables to meet your individual requirements.

Our products are manufactured to meet the latest UL, CSA and NEC requirements and approvals.

Section	Page
Multi-Conductor, Foil Shield	45-46
Multi-Conductor, Foil/Braid Shield	47-48
Multi-Conductor, Foil/Braid Shield, Lo-Cap®	49
Multi-Paired, Foil Shield	50
Multi-Paired, Foil Shield, Lo-Cap	51
Multi-Paired, Foil/Braid Shield	52
Multi-Paired, Foil/Braid Shield, Lo-Cap	53-55
Multi-Paired, Individually Foil Shielded	56
Multi-Paired, Individually Foil Shielded, Lo-Cap	57
Multi-Paired, Individually Foil/Braid Shielded, Lo-Cap	58

# Multi-Conductor, Foil Shield

UL 2464, NEC/CEC Type CMR, CMG UL/CSA

**Product Construction:**

**Conductor:**

- 24 AWG fully annealed stranded tinned copper per ASTM B33

**Insulation:**

- Premium-grade, color-coded PVC
- Color code: See charts below

**Shield:**

- 100% Flexfoil® aluminum/polyester with 25% overlap, foil facing out
- Stranded tinned copper drain wire

**Jacket:**

- PVC, gray
- Temperature range: -20°C to +105°C

**Applications:**

- Computer interconnections
- Data transmission
- Control circuits
- Industrial equipment control
- Suitable for EIA RS-232 applications
- Suggested voltage rating: 300 volts

**Compliances:**

- NEC Article 800 Type CMR (UL: 105°C)
- UL Style 2464 (UL: 105°C, 300 V)
- CSA CMG (CSA: 105°C)
- RoHS Compliant Directive 2015/863/EU (RoHS-3)
- Passes CSA CMG Flame Test

**Packaging:**

- Please contact Customer Service for packaging and color options
- Data subject to change.

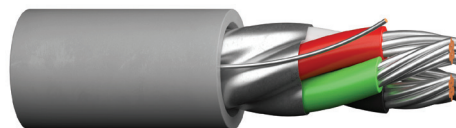

CATALOG NUMBER	NO. OF COND.	AWG SIZE	COND. STRAND	NOMINAL INSULATION THICKNESS		NOMINAL JACKET THICKNESS		NOMINAL O.D.		NOMINAL DCR Ω/ft @20°C		NOMINAL CAP.* pF/ft	
				in	mm	in	mm	in	mm	COND.	SHLD.	A	B
C0740A	2	24	7/32	0.010	0.25	0.032	0.81	0.157	3.99	26.0	7.2	36.0	64.0
C0741A	3	24	7/32	0.010	0.25	0.032	0.81	0.164	4.17	26.0	7.2	33.0	59.0
C0742A	4	24	7/32	0.010	0.25	0.032	0.81	0.175	4.45	26.0	7.2	33.0	59.0
C0753A	5	24	7/32	0.010	0.25	0.032	0.81	0.188	4.78	26.0	7.2	33.0	59.0
C0743A	6	24	7/32	0.010	0.25	0.032	0.81	0.201	5.11	26.0	7.2	30.0	55.0
C0754A	7	24	7/32	0.010	0.25	0.032	0.81	0.201	5.11	26.0	7.2	30.0	55.0
C0744A	8	24	7/32	0.010	0.25	0.032	0.81	0.215	5.46	26.0	7.2	30.0	55.0
C0755A	9	24	7/32	0.010	0.25	0.032	0.81	0.228	5.79	26.0	7.2	30.0	55.0
C0745A	10	24	7/32	0.010	0.25	0.032	0.81	0.245	6.22	26.0	7.2	30.0	55.0

\*A - Capacitance between conductors

\*B - Capacitance between one conductor and other conductors connected to shield

**COLOR CODE CHART 1**

For cables up to and including 10 conductors

NO. OF COND.	COLOR	NO. OF COND.	COLOR	NO. OF COND.	COLOR
1	Black	5	Light Brown	9	Purple
2	White	6	Light Blue	10	Gray
3	Red	7	Orange		
4	Light Green	8	Yellow		

CATALOG NUMBER	NO. OF COND.	AWG SIZE	COND. STRAND	NOMINAL INSULATION THICKNESS		NOMINAL JACKET THICKNESS		NOMINAL O.D.		NOMINAL DCR Ω/ft @20°C		NOMINAL CAP.* pF/ft	
				in	mm	in	mm	in	mm	COND.	SHLD.	A	B
C0746A	15	24	7/32	0.010	0.25	0.032	0.81	0.276	7.01	26.0	7.2	30.0	55.0
C0747A	20	24	7/32	0.010	0.25	0.032	0.81	0.303	7.70	26.0	7.2	30.0	55.0
C0748A	25	24	7/32	0.010	0.25	0.032	0.81	0.333	8.46	26.0	7.2	30.0	55.0
C0749A	30	24	7/32	0.010	0.25	0.032	0.81	0.351	8.92	26.0	7.2	30.0	55.0
C0750A	40	24	7/32	0.010	0.25	0.032	0.81	0.391	9.93	26.0	7.2	30.0	55.0
C0751A	50	24	7/32	0.010	0.25	0.032	0.81	0.439	11.15	26.0	7.2	30.0	55.0

\*A - Capacitance between conductors

\*B - Capacitance between one conductor and other conductors connected to shield

**COLOR CODE CHART 2 PER ICEA**

For cables of 15 thru 50 conductors

NO. OF COND.	COLOR	NO. OF COND.	COLOR	NO. OF COND.	COLOR	NO. OF COND.	COLOR	NO. OF COND.	COLOR
1	Black	11	Light Blue/Black	21	Orange/Green	31	Light Green/Black/Orange	41	Light Green/White/Blue
2	White	12	Black/White	22	Black/White/Red	32	Orange/Black/Green	42	Orange/Red/Green
3	Red	13	Red/White	23	White/Black/Red	33	Light Blue/White/Orange	43	Light Blue/Red/Green
4	Light Green	14	Light Green/White	24	Red/Black/White	34	Black/White/Orange	44	Black/White/Blue
5	Orange	15	Light Blue/White	25	Light Green/Black/White	35	White/Red/Orange	45	White/Black/Blue
6	Light Blue	16	Black/Red	26	Orange/Black/White	36	Orange/White/Blue	46	Red/White/Blue
7	White/Black	17	White/Red	27	Light Blue/Black/White	37	White/Red/Blue	47	Light Green/Orange/Red
8	Red/Black	18	Orange/Red	28	Black/Red/Green	38	Black/White/Green	48	Orange/Red/Blue
9	Light Green/Black	19	Light Blue/Red	29	White/Red/Green	39	White/Black/Green	49	Light Blue/Red/Orange
10	Orange/Black	20	Red/Green	30	Red/Black/Green	40	Red/White/Green	50	Black/Orange/Red



# Multi-Conductor, Foil Shield

UL 2464, NEC/CEC Type CM or CMR, CMG UL/CSA



**Product Construction:**

**Conductor:**

- 22 or 20 AWG fully annealed stranded tinned copper per ASTM B33

**Insulation:**

- Premium-grade, color-coded PVC
- Color code: See chart below

**Shield:**

- 100% Flexfoil® aluminum/polyester with 25% overlap, minimum, foil facing out
- Stranded tinned copper drain wire

**Jacket:**

- PVC, gray
- Temperature range: -20°C to +105°C

**Applications:**

- Computer interconnections
- Data transmission
- Control circuits
- Industrial equipment control
- Suitable for EIA RS-232 applications
- Suggested voltage rating: 300 volts

**Compliances:**

- NEC Article 800 Type CM - 20 AWG (UL: 105°C)
- NEC Article 800 Type CMR - 20 AWG (UL: 105°C)
- UL Style 2464 (UL: 80°C, 300 V)
- CSA CMG (CSA: 105°C)
- RoHS Compliant Directive 2015/863/EU (RoHS-3)
- Passes CSA CMG Flame Test

**Packaging:**

- Please contact Customer Service for packaging and color options

CATALOG NUMBER	NO. OF COND.	AWG SIZE	COND. STRAND	NOMINAL INSULATION THICKNESS		NOMINAL JACKET THICKNESS		NOMINAL O.D.		NOMINAL DCR $\Omega$ /kft @20°C		NOMINAL CAP.* pF/ft	
				in	mm	in	mm	in	mm	COND.	SHLD.	A	B

**PVC - CMR (UL) c(UL)**

C0760A	2	22	7/30	0.010	0.25	0.032	0.81	0.169	4.29	16.5	6.3	36.0	65.0
C0761A	3	22	7/30	0.010	0.25	0.032	0.81	0.177	4.50	16.5	6.3	36.0	65.0
C0762A	4	22	7/30	0.010	0.25	0.032	0.81	0.190	4.83	16.5	6.3	36.0	65.0
C0763A	6	22	7/30	0.010	0.25	0.032	0.81	0.219	5.56	16.5	6.3	34.0	61.0
C0764A	8	22	7/30	0.010	0.25	0.032	0.81	0.235	5.97	16.5	6.3	34.0	61.0
C0765A	10	22	7/30	0.010	0.25	0.032	0.81	0.269	6.83	16.5	6.3	34.0	61.0
C0766A	15	22	7/30	0.010	0.25	0.032	0.81	0.304	7.72	16.5	6.3	34.0	61.0
C0767A	20	22	7/30	0.010	0.25	0.032	0.81	0.335	8.51	16.5	6.3	34.0	61.0
C0768A	25	22	7/30	0.010	0.25	0.032	0.81	0.369	9.37	16.5	6.3	34.0	61.0

**PVC - CM (UL) c(UL)**

C0780A	2	20	7/28	0.016	0.41	0.032	0.81	0.207	5.26	11.0	6.3	39.0	70.0
C0781A	3	20	7/28	0.016	0.41	0.032	0.81	0.217	5.51	11.0	6.3	39.0	70.0
C0782A	4	20	7/28	0.016	0.41	0.032	0.81	0.236	5.99	11.0	6.3	39.0	70.0
C0783A	6	20	7/28	0.016	0.41	0.032	0.81	0.276	7.01	11.0	6.3	37.0	66.0
C0784A	8	20	7/28	0.016	0.41	0.032	0.81	0.297	7.54	11.0	6.3	37.0	66.0
C0785A	10	20	7/28	0.016	0.41	0.032	0.81	0.345	8.76	11.0	6.3	37.0	66.0
C0786A	15	20	7/28	0.016	0.41	0.032	0.81	0.393	9.98	11.0	6.3	37.0	66.0
C0787A	20	20	7/28	0.016	0.41	0.032	0.81	0.435	11.05	11.0	6.3	37.0	66.0
C0788A	25	20	7/28	0.016	0.41	0.032	0.81	0.483	12.27	11.0	6.3	40.0	72.0

\*A - Capacitance between conductors

\*B - Capacitance between one conductor and other conductors connected to shield

Data subject to change.

**COLOR CODE CHART**

NO. OF COND.	COLOR	NO. OF COND.	COLOR	NO. OF COND.	COLOR	NO. OF COND.	COLOR	NO. OF COND.	COLOR
1	Black	6	Blue	11	Blue/Black	16	Black/Red	21	Orange/Green
2	White	7	White/Black	12	Black/White	17	White/Red	22	Black/White/Red
3	Red	8	Red/Black	13	Red/White	18	Orange/Red	23	White/Black/Red
4	Green	9	Green/Black	14	Green/White	19	Blue/Red	24	Red/Black/White
5	Orange	10	Orange/Black	15	Blue/White	20	Red/Green	25	Green/Black/White



# Multi-Conductor, Foil/Braid Shield

UL 2464, NEC Type CL2 or NEC/CEC Type CM, CMG UL/CSA

**Product Construction:**

**Conductor:**

- 28 and 24 AWG fully annealed stranded tinned copper per ASTM B33

**Insulation:**

- Premium-grade, color-coded PVC
- Color code: See charts below

**Shield:**

- 100% Flexfoil® aluminum/polyester with 25% overlap, minimum, foil facing out
- Stranded tinned copper drain wire
- 65% tinned copper braid

**Jacket:**

- PVC, gray
- Temperature range: -20°C to +105°C

**Applications:**

- Computers
- Industrial equipment
- Data transmission
- Control circuits
- Suitable for EIA RS-232 applications
- Suggested voltage rating: 300 volts

**Compliances:**

- NEC Article 800 Type CM - 24 AWG (UL: 105°C)
- UL Style 2464 (UL: 80°C, 300 V)
- CSA CMG (CSA: 105°C)
- RoHS Compliant Directive 2015/863/EU (RoHS-3)
- Passes CSA CMG Flame Test

**Packaging:**

- Please contact Customer Service for packaging and color options

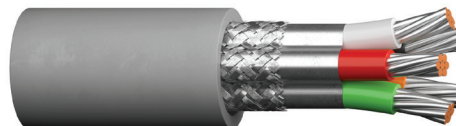

CATALOG NUMBER	NO. OF COND.	AWG SIZE	COND. STRAND	NOMINAL INSULATION THICKNESS		NOMINAL JACKET THICKNESS		NOMINAL O.D.		NOMINAL DCR Ω/kft @20°C		NOMINAL CAP.** pF/ft	
				in	mm	in	mm	in	mm	COND.	SHLD.	A	B
<b>CM, CMG, UL 2464</b>													
<b>C0951A</b>	3	24	7/32	0.010	0.25	0.032	0.81	0.186	4.72	25.7	5.3	33.0	59.0
<b>C0952A</b>	4	24	7/32	0.010	0.25	0.032	0.81	0.197	5.00	25.7	5.5	33.0	59.0
<b>C0953A</b>	5	24	7/32	0.010	0.25	0.032	0.81	0.210	5.33	25.7	4.4	33.0	59.0
<b>C0954A</b>	6	24	7/32	0.010	0.25	0.032	0.81	0.223	5.66	25.7	4.6	30.0	55.0
<b>C0955A</b>	7	24	7/32	0.010	0.25	0.032	0.81	0.223	5.66	25.7	4.6	30.0	55.0
<b>C0956A</b>	8	24	7/32	0.010	0.25	0.032	0.81	0.237	6.02	25.7	3.8	30.0	55.0
<b>C0957A</b>	9	24	7/32	0.010	0.25	0.032	0.81	0.250	6.35	25.7	3.9	30.0	55.0
<b>C0958A</b>	10	24	7/32	0.010	0.25	0.032	0.81	0.267	6.78	25.7	4.2	30.0	55.0
<b>C0959A</b>	15	24	7/32	0.010	0.25	0.032	0.81	0.298	7.57	25.7	3.6	30.0	55.0
<b>C0960A</b>	20	24	7/32	0.010	0.25	0.032	0.81	0.325	8.26	25.7	4.5	30.0	55.0
<b>C0961A</b>	25	24	7/32	0.010	0.25	0.032	0.81	0.355	9.02	25.7	3.5	30.0	55.0

\*Color Code Chart 1. Remaining items Color Code Chart 2  
 \*\*A - Capacitance between conductors  
 \*\*B - Capacitance between one conductor and other conductors connected to shield  
 Data subject to change.

**COLOR CODE CHART 1**

For cables up to and including 10 conductors

NO. OF COND.	COLOR	NO. OF COND.	COLOR	NO. OF COND.	COLOR
<b>1</b>	Black	<b>5</b>	Light Brown	<b>9</b>	Purple
<b>2</b>	White	<b>6</b>	Light Blue	<b>10</b>	Gray
<b>3</b>	Red	<b>7</b>	Orange		
<b>4</b>	Light Green	<b>8</b>	Yellow		

**COLOR CODE CHART 2 Per ICEA**

NO. OF COND.	COLOR	NO. OF COND.	COLOR	NO. OF COND.	COLOR	NO. OF COND.	COLOR	NO. OF COND.	COLOR
<b>1</b>	Black	<b>6</b>	Light Blue	<b>11</b>	Light Blue/Black	<b>16</b>	Black/Red	<b>21</b>	Orange/Green
<b>2</b>	White	<b>7</b>	White/Black	<b>12</b>	Black/White	<b>17</b>	White/Red	<b>22</b>	Black/White/Red
<b>3</b>	Red	<b>8</b>	Red/Black	<b>13</b>	Red/White	<b>18</b>	Orange/Red	<b>23</b>	White/Black/Red
<b>4</b>	Light Green	<b>9</b>	Light Green/Black	<b>14</b>	Light Green/White	<b>19</b>	Light Blue/Red	<b>24</b>	Red/Black/White
<b>5</b>	Orange	<b>10</b>	Orange/Black	<b>15</b>	Light Blue/White	<b>20</b>	Red/Green	<b>25</b>	Light Green/Black/White



# Multi-Conductor, Foil/Braid Shield

UL 2464, NEC/CEC Type CMR, CMG UL/CSA



**Product Construction:**

**Conductor:**

- 22 AWG fully annealed stranded tinned copper per ASTM B33

**Insulation:**

- Premium-grade, color-coded PVC
- Color code: See chart below

**Shield:**

- 100% Flexfoil® aluminum/polyester with 25% overlap, minimum, foil facing out
- 65% tinned copper braid

**Jacket:**

- PVC, gray
- Temperature range: -20°C to +105°C

**Applications:**

- Computers
- Industrial equipment
- Data transmission
- Control circuits
- Suitable for EIA RS-232 applications
- Suggested voltage rating: 300 volts

**Compliances:**

- NEC Article 800 Type CMR (UL: 105°C)
- UL Style 2464 (UL: 80°C, 300 V)
- CSA CMG (CSA: 105°C)
- RoHS Compliant Directive 2015/863/EU (RoHS-3)
- Passes CSA CMG Flame Test

**Packaging:**

- Please contact Customer Service for packaging and color options

CATALOG NUMBER	NO. OF COND.	AWG SIZE	COND. STRAND	NOMINAL INSULATION THICKNESS		NOMINAL JACKET THICKNESS		NOMINAL O.D.		NOMINAL DCR @/kft @20°C		NOMINAL CAP.* pF/ft	
				in	mm	in	mm	in	mm	COND.	SHLD.	A	B
C0971A	3	22	7/30	0.010	0.25	0.032	0.81	0.199	5.05	16.6	5.6	36.0	66.0
C0972A	4	22	7/30	0.010	0.25	0.032	0.81	0.212	5.38	16.6	4.4	36.0	66.0
C0973A	5	22	7/30	0.010	0.25	0.032	0.81	0.226	5.74	16.6	4.7	36.0	66.0
C0974A	6	22	7/30	0.010	0.25	0.032	0.81	0.241	6.12	16.6	3.8	34.0	60.0
C0975A	7	22	7/30	0.010	0.25	0.032	0.81	0.241	6.12	16.6	6.2	34.0	60.0
C0976A	8	22	7/30	0.010	0.25	0.032	0.81	0.257	6.53	16.6	4.0	34.0	60.0
C0977A	9	22	7/30	0.010	0.25	0.032	0.81	0.272	6.91	16.6	3.4	34.0	60.0
C0978A	10	22	7/30	0.010	0.25	0.032	0.81	0.291	7.39	16.6	3.6	34.0	60.0
C0979A	15	22	7/30	0.010	0.25	0.032	0.81	0.326	8.28	16.6	3.6	34.0	60.0
C0980A	20	22	7/30	0.010	0.25	0.032	0.81	0.357	9.07	16.6	3.9	34.0	60.0
C0981A	25	22	7/30	0.010	0.25	0.032	0.81	0.391	9.93	16.6	2.7	34.0	60.0

\*A – Capacitance between conductors

\*B – Capacitance between one conductor and other conductors connected to shield  
Data subject to change.

**COLOR CODE CHART Per ICEA**

NO. OF COND.	COLOR	NO. OF COND.	COLOR	NO. OF COND.	COLOR	NO. OF COND.	COLOR	NO. OF COND.	COLOR
1	Black	6	Light Blue	11	Light Blue/Black	16	Black/Red	21	Orange/Green
2	White	7	White/Black	12	Black/White	17	White/Red	22	Black/White/Red
3	Red	8	Red/Black	13	Red/White	18	Orange/Red	23	White/Black/Red
4	Light Green	9	Light Green/Black	14	Light Green/White	19	Light Blue/Red	24	Red/Black/White
5	Orange	10	Orange/Black	15	Light Blue/White	20	Red/Green	25	Light Green/Black/White



# Multi-Conductor, Foil/Braid Shield, Lo-Cap®

UL 2919, NEC Type CL2 or NEC/CEC Type CM, CEC Type CMH UL/CSA

**Product Construction:**

**Conductor:**

- 24 AWG fully annealed stranded tinned copper per ASTM B33

**Insulation:**

- Premium grade foamed Lo-Cap® color coded polypropylene
- Color code: See chart below

**Shield:**

- 100% Flexfoil® aluminum/polyester with 25% overlap, minimum, foil facing out
- Stranded tinned copper drain wire
- 70% tinned copper braid

**Jacket:**

- PVC, gray
- Temperature range: -20°C to +80°C

**Applications:**

- High speed computers
- Industrial equipment
- Control circuits
- Designed for low capacitance applications
- Suitable for EIA RS-232 and RS-423 CAD/CAM applications
- Suggested voltage rating: 30 volts

**Compliances:**

- NEC Article 800 Type CM (UL: 75°C, 300 V)
- UL Style 2919 (UL: 80°C, 30 V)
- CSA CMH (CSA: 60°C)
- RoHS Compliant Directive 2015/863/EU (RoHS-3)
- Passes CSA CMH Flame Test

**Packaging:**

- Please contact Customer Service for packaging and color options

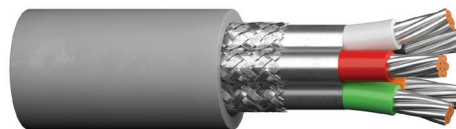

CATALOG NUMBER	NO. OF COND.	NOM. INSULATION THICKNESS		NOM. JACKET THICKNESS		NOMINAL O.D.		NOMINAL DCR Ω/kft		NOMINAL CAP.* pF/ft	
		in	mm	in	mm	in	mm	COND.	SHLD.	A	B
<b>24 AWG (7/32): CM (UL) c(UL) CMH, AWM Style 2919</b>											
<b>C0680A</b>	3	0.016	0.41	0.032	0.81	0.211	5.36	25.7	3.8	11.9	21.5
<b>C0681A</b>	4	0.016	0.41	0.032	0.81	0.227	5.77	25.7	3.8	11.9	21.5
<b>C0682A</b>	5	0.016	0.41	0.032	0.81	0.242	6.15	25.7	3.8	11.9	21.5
<b>C0683A</b>	6	0.016	0.41	0.032	0.81	0.259	6.58	25.7	3.2	11.2	20.2
<b>C0684A</b>	7	0.016	0.41	0.032	0.81	0.259	6.58	25.7	3.2	11.2	20.2
<b>C0685A</b>	8	0.016	0.41	0.032	0.81	0.276	7.01	25.7	3.2	11.2	20.2
<b>C0686A</b>	9	0.016	0.41	0.032	0.81	0.293	7.44	25.7	3.6	11.2	20.2
<b>C0687A</b>	10	0.016	0.41	0.032	0.81	0.315	8.00	25.7	3.6	11.2	20.2
<b>C0688A</b>	15	0.016	0.41	0.032	0.81	0.354	8.99	25.7	3.6	11.2	20.2

\*A – Capacitance between conductors  
 \*B – Capacitance between one conductor and other conductors connected to shield  
 Vp = 78%  
 Impedance: ≈100 Ω  
 Data subject to change.

**COLOR CODE CHART 1**

For cables up to and including 10 conductors

NO. OF COND.	COLOR	NO. OF COND.	COLOR	NO. OF COND.	COLOR
<b>1</b>	Black	<b>5</b>	Brown	<b>9</b>	Purple
<b>2</b>	White	<b>6</b>	Light Blue	<b>10</b>	Gray
<b>3</b>	Red	<b>7</b>	Orange		
<b>4</b>	Light Green	<b>8</b>	Yellow		

**COLOR CODE CHART 2 PER ICEA**

For cables up to 15 conductors

NO. OF COND.	COLOR	NO. OF COND.	COLOR	NO. OF COND.	COLOR
<b>1</b>	Black	<b>6</b>	Light Blue	<b>11</b>	Light Blue/Black
<b>2</b>	White	<b>7</b>	White/Black	<b>12</b>	Black/White
<b>3</b>	Red	<b>8</b>	Red/Black	<b>13</b>	Red/White
<b>4</b>	Light Green	<b>9</b>	Light Green/Black	<b>14</b>	Light Green/White
<b>5</b>	Orange	<b>10</b>	Orange/Black	<b>15</b>	Light Blue/White



# Multi-Paired, Foil Shield

UL 2464, NEC/CEC Type CMR, CMG UL/CSA



**Product Construction:**

**Conductor:**

- 24 AWG fully annealed stranded tinned copper per ASTM B33
- Twisted pairs

**Insulation:**

- Premium-grade, color-coded PVC
- Color code: See chart below

**Shield:**

- 100% Flexfoil® aluminum/polyester with 25% overlap, minimum, foil facing out
- Stranded tinned copper drain wire

**Jacket:**

- PVC, gray
- Temperature range: -20°C to +105°C

**Applications:**

- Computers
- Industrial equipment
- Data transmission
- Control circuits
- Suitable for EIA RS-232 applications
- Suggested voltage rating: 300 volts

**Compliances:**

- NEC Article 800 Type CMR (UL: 105°C)
- UL Style 2464 (UL: 80°C, 300 V)
- CSA CMG (CSA, 105°C)
- RoHS Compliant Directive 2015/863/EU (RoHS-3)
- Passes CSA CMG Flame Test

**Packaging:**

- Please contact Customer Service for packaging and color options
- Data subject to change.

CATALOG NUMBER	NO. OF PAIRS	AWG SIZE	COND. STRAND	NOMINAL INSULATION THICKNESS		NOMINAL JACKET THICKNESS		NOMINAL O.D.		NOMINAL DCR Ω/kft		NOMINAL CAP.* pF/ft	
				in	mm	in	mm	in	mm	COND.	SHLD.	A	B
C0600A	1	24	7/32	0.010	0.25	0.032	0.81	0.157	3.99	25.7	7.2	19.7	21.5
C0601A	2	24	7/32	0.010	0.25	0.032	0.81	0.214	5.44	25.7	7.2	28.7	21.5
C0602A	3	24	7/32	0.010	0.25	0.032	0.81	0.225	5.72	25.7	7.2	25.7	21.5
C0603A	4	24	7/32	0.010	0.25	0.032	0.81	0.245	6.23	25.7	7.2	25.7	20.2
C0604A	5	24	7/32	0.010	0.25	0.032	0.81	0.265	6.73	25.7	7.2	25.7	20.2
C0605A	6	24	7/32	0.010	0.25	0.032	0.81	0.287	7.29	25.7	7.2	23.7	42.7
C0606A	7	24	7/32	0.010	0.25	0.032	0.81	0.287	7.29	25.7	7.2	23.7	42.7
C0607A	8	24	7/32	0.010	0.25	0.032	0.81	0.309	7.85	25.7	7.2	23.7	42.7
C0608A	9	24	7/32	0.010	0.25	0.032	0.81	0.331	8.41	25.7	7.2	23.7	42.7
C0609A	10	24	7/32	0.010	0.25	0.032	0.81	0.359	9.12	25.7	7.2	23.7	42.7
C0610A	15	24	7/32	0.010	0.25	0.032	0.81	0.410	10.41	25.7	7.2	23.7	42.7
C0611A	19	24	7/32	0.010	0.25	0.032	0.81	0.432	10.97	25.7	7.2	23.7	42.7
C0612A	25	24	7/32	0.010	0.25	0.032	0.81	0.505	12.84	25.7	7.2	23.7	42.7
C0720A	1	22	7/30	0.010	0.25	0.032	0.81	0.169	4.29	16.6	6.2	40.4	72.6
C0721A	2	22	7/30	0.010	0.25	0.032	0.81	0.234	5.94	16.6	6.2	32.3	58.1
C0722A	3	22	7/30	0.010	0.25	0.032	0.81	0.246	6.25	16.6	6.2	27.8	50.1
C0723A	4	22	7/30	0.010	0.25	0.032	0.81	0.269	6.83	16.6	6.2	27.8	50.1
C0724A	5	22	7/30	0.010	0.25	0.032	0.81	0.292	7.42	16.6	6.2	27.8	50.1
C0725A	6	22	7/30	0.010	0.25	0.032	0.81	0.317	8.05	16.6	6.2	25.5	45.9
C0726A	9	22	7/30	0.010	0.25	0.032	0.81	0.367	9.32	16.6	6.2	25.5	45.9
C0728A	15	22	7/30	0.010	0.25	0.032	0.81	0.457	11.62	16.6	6.2	25.5	45.9
C0729A	19	22	7/30	0.010	0.25	0.032	0.81	0.482	12.24	16.6	6.2	25.5	45.9
C0730A	27	22	7/30	0.010	0.25	0.032	0.81	0.576	14.36	16.6	6.2	26.0	46.0

\*A – Capacitance between conductors

\*B – Capacitance between one conductor and other conductors connected to shield

**COLOR CODE CHART**

NO. OF PAIRS	COLOR	NO. OF PAIRS	COLOR		
1	Black with Red	10	Red with Blue	19	White with Blue
2	Black with White	11	Red with Yellow	20	White with Yellow
3	Black with Green	12	Red with Brown	21	White with Brown
4	Black with Blue	13	Red with Orange	22	White with Orange
5	Black with Yellow	14	Green with White	23	Blue with Yellow
6	Black with Brown	15	Green with Blue	24	Blue with Brown
7	Black with Orange	16	Green with Yellow	25	Blue with Orange
8	Red with White	17	Green with Brown	26	Brown with Yellow
9	Red with Green	18	Green with Orange	27	Brown with Orange





# Multi-Paired, Foil Shield, Lo-Cap®

UL 2448, NEC Type CM (UL) c(UL), CMH

**Product Construction:**

**Conductor:**

- 24 AWG fully annealed stranded tinned copper per ASTM B33
- Twisted pairs

**Insulation:**

- Premium-grade, color-coded polyethylene
- Color code: See chart below

**Shield:**

- 100% Flexfoil® aluminum/polyester with 25% overlap, minimum, foil facing out
- Stranded tinned copper drain wire

**Jacket:**

- PVC, gray
- Temperature range: -20°C to +75°C

**Applications:**

- Computers
- Industrial equipment
- Data transmission
- Control circuits
- Suitable for low capacitance applications
- Suggested voltage rating: 30 volts

**Compliances:**

- NEC Article 800 Type CM (UL: 75°C)
- UL Style 2448 (UL: 60°C, 30 V)
- CSA CMH (CSA: 60°C)
- RoHS Compliant Directive 2015/863/EU (RoHS-3)
- Passes CSA CMH Flame Test

**Packaging:**

- Please contact Customer Service for packaging and color options



CATALOG NUMBER	NO. OF PAIRS	AWG SIZE	COND. STRAND	NOM. INSULATION THICKNESS		NOM. JACKET THICKNESS		NOMINAL O.D.		NOMINAL DCR Ω/kft		VEL. OF PROP. %	NOM. IMP. Ω	NOMINAL CAP.* pF/ft	
				in	mm	in	mm	in	mm	COND.	SHLD.			A	B
<b>C0890A</b>	2	24	7/32	0.015	0.38	0.032	0.81	0.247	6.27	25.7	7.20	66	100	14.4	26.0
<b>C0901A</b>	3	24	7/32	0.015	0.38	0.032	0.81	0.261	6.63	25.7	7.20	66	100	13.9	25.1
<b>C0893A</b>	4	24	7/32	0.015	0.38	0.032	0.81	0.277	7.04	25.7	7.20	66	100	13.9	25.1
<b>C0894A</b>	5	24	7/32	0.015	0.38	0.032	0.81	0.310	7.87	25.7	7.20	66	100	13.9	25.1
<b>C0899A</b>	6	24	7/32	0.015	0.38	0.032	0.81	0.336	8.53	25.7	7.20	66	100	13.0	23.4
<b>C0896A</b>	9	24	7/32	0.015	0.38	0.032	0.81	0.391	9.93	25.7	7.20	66	100	13.0	23.4
<b>C0897A</b>	12.5	24	7/32	0.015	0.38	0.032	0.97	0.459	11.66	25.7	7.20	66	100	13.0	23.4

\*A – Capacitance between conductors

\*B – Capacitance between one conductor and other conductors connected to shield  
Data subject to change.

**COLOR CODE CHART**

NO. OF PAIRS	COLOR	NO. OF PAIRS	COLOR	NO. OF PAIRS	COLOR
<b>1</b>	Black paired with White	<b>5</b>	Purple paired with Gray	<b>9</b>	White/Orange paired with Orange/White
<b>2</b>	Red paired with Green	<b>6</b>	Tan paired with Pink	<b>10</b>	White/Green paired with Green/White
<b>3</b>	Brown paired with Blue	<b>7</b>	White/Blue paired with Blue/White	<b>11</b>	White/Red paired with Red/White
<b>4</b>	Orange paired with Yellow	<b>8</b>	White/Brown paired with Brown/White	<b>12</b>	White/Black paired with Black/White
Single Conductor: Green With Yellow Stripe					



# Multi-Paired, Foil/Braid Shield

UL 2464, NEC/CEC Type CMR, CMG UL/CSA

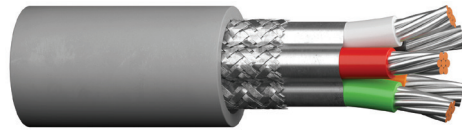

CATALOG NUMBER	NO. OF PAIRS	AWG SIZE	COND. STRAND	NOMINAL INSULATION THICKNESS		NOMINAL JACKET THICKNESS		NOMINAL O.D.		NOMINAL DCR $\Omega$ /kft		NOMINAL CAP.* pF/ft	
				in	mm	in	mm	in	mm	COND.	SHLD.	A	B
C0620A	2	24	7/32	0.010	0.25	0.032	0.81	0.235	5.97	25.7	5.4	29.5	53.0
C0621A	3	24	7/32	0.010	0.25	0.032	0.81	0.231	5.87	25.7	5.0	26.4	47.6
C0622A	4	24	7/32	0.010	0.25	0.032	0.81	0.253	6.43	25.7	4.5	26.4	47.6
C0623A	5	24	7/32	0.010	0.25	0.032	0.81	0.278	7.06	25.7	4.6	26.4	47.6
C0624A	6	24	7/32	0.010	0.25	0.032	0.81	0.296	7.52	25.7	2.9	24.4	43.9
C0625A	7	24	7/32	0.010	0.25	0.032	0.81	0.313	7.95	25.7	3.1	24.4	43.9
C0626A	8	24	7/32	0.010	0.25	0.032	0.81	0.336	8.53	25.7	4.1	24.4	43.9
C0628A	10	24	7/32	0.010	0.25	0.032	0.81	0.357	9.07	25.7	2.6	24.4	43.9
C0630A	12.5	24	7/32	0.010	0.25	0.032	0.81	0.386	9.80	25.7	3.6	24.4	43.9
C0650A	2	22	7/30	0.010	0.25	0.032	0.81	0.229	5.82	16.6	3.8	33.2	59.7
C0651A	3	22	7/30	0.010	0.25	0.032	0.81	0.296	7.52	16.6	4.1	28.6	51.5
C0652A	4	22	7/30	0.010	0.25	0.032	0.81	0.320	8.13	16.6	3.5	28.6	51.5
C0653A	5	22	7/30	0.010	0.25	0.032	0.81	0.331	8.41	16.6	3.9	28.6	51.5
C0654A	6	22	7/30	0.010	0.25	0.032	0.81	0.348	8.84	16.6	4.4	26.2	47.2
C0655A	7	22	7/30	0.010	0.25	0.032	0.81	0.348	8.84	16.6	5.0	26.2	47.2
C0656A	8	22	7/30	0.010	0.25	0.032	0.81	0.368	9.35	16.6	3.8	26.2	47.2
C0658A	10	22	7/30	0.010	0.25	0.032	0.81	0.388	9.86	16.6	4.1	26.2	47.2
C0660A	12.5	22	7/30	0.010	0.25	0.032	0.81	0.429	10.90	16.6	4.7	26.2	47.2
C0663A	25	22	7/30	0.010	0.25	0.058	0.81	0.620	15.75	16.6	2.1	26.2	46.0

\*A – Capacitance between conductors

\*B – Capacitance between one conductor and other conductors connected to shield

## COLOR CODE CHART

NO. OF PAIRS	COLOR	NO. OF PAIRS	COLOR	NO. OF PAIRS	COLOR
1	Black paired with Red	10	Red paired with Blue	19	White paired with Blue
2	Black paired with White	11	Red paired with Yellow	20	White paired with Yellow
3	Black paired with Green	12	Red paired with Brown	21	White paired with Brown
4	Black paired with Blue	13	Red paired with Orange	22	White paired with Orange
5	Black paired with Yellow	14	White paired with Green	23	Yellow paired with Blue
6	Black paired with Brown	15	Blue paired with Green	24	Blue paired with Brown
7	Black paired with Orange	16	Yellow paired with Green	25	Orange paired with Blue
8	Red paired with White	17	Brown paired with Green		
9	Red paired with Green	18	Orange paired with Green		

Single Conductor: Green With Yellow Stripe

### Product Construction:

#### Conductor:

- 22 and 24 AWG fully annealed stranded tinned copper per ASTM B33
- Twisted pairs

#### Insulation:

- Premium-grade, color-coded PVC
- Color code: See chart below

#### Shield:

- 100% Flexfoil® aluminum/polyester with 25% overlap, minimum, foil facing out
- 65% tinned copper braid

#### Jacket:

- PVC, gray
- Temperature range: -20°C to +105°C

### Applications:

- Computers
- Industrial equipment
- Data transmission
- Control circuits
- Suitable for EIA RS-232 applications
- Suggested voltage rating: 300 volts

### Compliances:

- NEC Article 800 Type CMR (UL: 105°C)
- UL Style 2464 (UL: 80°C, 300 V)
- CSA CMG (CSA: 105°C)
- RoHS Compliant Directive 2015/863/EU (RoHS-3)
- Passes CSA CMG Flame Test

### Packaging:

- Please contact Customer Service for packaging and color options
- Data subject to change.



# Multi-Paired, Foil/Braid Shield, Lo-Cap®

UL 2919, NEC Type CM (UL) c(UL) CMH

**Product Construction:**

**Conductor:**

- 24 AWG fully annealed stranded tinned copper per ASTM B33
- Twisted pairs

**Insulation:**

- Premium-grade, color-coded polyethylene
- Color code: See charts below

**Shield:**

- 100% Flexfoil® aluminum/polyester with 25% overlap, minimum, foil facing out
- Stranded tinned copper drain wire
- 90% tinned copper braid

**Jacket:**

- PVC, gray
- Temperature range: -20°C to +80°C

**Applications:**

- Computers
- Industrial equipment
- Data transmission
- Control circuits
- Low capacitance requirements
- Suitable for EIA RS-485 applications
- Suggested voltage rating: 30 volts

**Compliances:**

- NEC Article 800 Type CM/CMH (UL: 75°C, 300 V)
- UL Style 2919 (UL: 80°C, 30 V)
- RoHS Compliant Directive 2015/863/EU (RoHS-3)
- Passes CSA CMH Flame Test

**Packaging:**

- Please contact Customer Service for packaging and color options

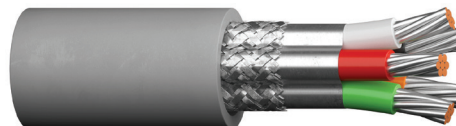

CATALOG NUMBER	NO. OF PAIRS	AWG SIZE	COND. STRAND	NOM. INSULATION THICKNESS		NOM. JACKET THICKNESS		NOMINAL O.D.		NOMINAL DCR Ω/kft		VEL. OF PROP. %	NOM. IMP. Ω	NOMINAL CAP.* pF/ft	
				in	mm	in	mm	in	mm	COND.	SHLD.			A	B
<b>C0841A</b>	1	24	7/32	0.024	0.61	0.032	0.81	0.235	5.97	25.7	2.9	66	120	14.6	26.2
<b>C0842A</b>	2	24	7/32	0.024	0.61	0.032	0.81	0.304	7.72	25.7	2.3	66	120	11.7	21.0
<b>C0843A</b>	3	24	7/32	0.024	0.61	0.032	0.81	0.360	9.14	25.7	2.3	66	120	11.9	21.4
<b>C0844A</b>	4	24	7/32	0.024	0.61	0.032	0.81	0.390	9.91	25.7	2.1	66	120	11.9	21.4

\*A – Capacitance between conductors

\*B – Capacitance between one conductor and other conductors connected to shield  
Data subject to change.

**COLOR CODE CHART 1**

NO. OF PAIRS	COLOR
<b>1</b>	Black paired with Red
<b>2</b>	Black paired with White
<b>3</b>	Black paired with Green
<b>4</b>	Black paired with Blue

CATALOG NUMBER	NO. OF PAIRS	AWG SIZE	COND. STRAND	NOM. INSULATION THICKNESS		NOM. JACKET THICKNESS		NOMINAL O.D.		NOMINAL DCR Ω/kft		VEL. OF PROP. %	NOM. IMP. Ω	NOMINAL CAP.* pF/ft	
				in	mm	in	mm	in	mm	COND.	SHLD.			A	B
<b>C4841A</b>	1	24	7/32	0.024	0.61	0.032	0.81	0.235	5.97	25.7	2.9	66	120	14.6	26.2
<b>C4842A</b>	2	24	7/32	0.024	0.61	0.032	0.81	0.304	7.72	25.7	2.3	66	120	11.7	21.0
<b>C4843A</b>	3	24	7/32	0.024	0.61	0.032	0.81	0.360	9.14	25.7	2.3	66	120	11.9	21.4
<b>C4844A</b>	4	24	7/32	0.024	0.61	0.032	0.81	0.390	9.91	25.7	2.1	66	120	11.9	21.4

\*A – Capacitance between conductors

\*B – Capacitance between one conductor and other conductors connected to shield  
Data subject to change.

**COLOR CODE CHART 2**

NO. OF PAIRS	COLOR	NO. OF PAIRS	COLOR
<b>1</b>	White-Blue Stripe Blue-White Stripe	<b>1</b>	White-Green Stripe Green-White Stripe
<b>2</b>	White-Orange Stripe Orange-White Stripe	<b>2</b>	White-Brown Stripe Brown-White Stripe



# Multi-Paired, Foil/Braid Shield, Lo-Cap®

UL 2919, NEC Type CM (UL) c(UL) CMH



**Product Construction:**

**Conductor:**

- 24 AWG fully annealed stranded tinned copper per ASTM B33
- Twisted pairs

**Insulation:**

- Premium-grade, color-coded polyethylene
- Color code: See chart below

**Shield:**

- 100% Flexfoil® aluminum/polyester with 25% overlap, minimum, foil facing out
- Stranded tinned copper drain wire
- 90% tinned copper braid

**Jacket:**

- PVC, gray
- Temperature range: -20°C to +80°C

**Applications:**

- Computers
- Industrial equipment
- Data transmission
- Control circuits
- Low capacitance requirements
- Suitable for EIA RS-232 applications
- Suitable for EIA RS-422 applications

**Compliances:**

- NEC Article 800 Type CM/CMH (UL: 75°C)
- UL Style 2919 (UL: 80°C, 30 V)
- CSA CMH (CSA: 60°C)
- RoHS Compliant Directive 2015/863/EU (RoHS-3)
- Passes CSA CMH Flame Test

**Packaging:**

- Please contact Customer Service for packaging and color options

CATALOG NUMBER	NO. OF PAIRS	AWG SIZE	COND. STRAND	NOM. INSULATION THICKNESS		NOM. JACKET THICKNESS		NOMINAL O.D.		NOMINAL DCR Ω/kft		VEL. OF PROP. %	NOM. IMP. Ω	NOMINAL CAP.* pF/ft	
				in	mm	in	mm	in	mm	COND.	SHLD.			A	B
<b>C0829A</b>	2	24	7/32	0.015	0.38	0.032	0.81	0.257	6.53	25.7	2.7	66	100	14.8	26.7
<b>C0830A</b>	3	24	7/32	0.015	0.38	0.032	0.81	0.289	7.34	25.7	2.6	66	100	14.2	25.5
<b>C0831A</b>	4	24	7/32	0.015	0.38	0.032	0.81	0.313	7.95	25.7	3.2	66	100	14.2	25.5
<b>C0832A</b>	5	24	7/32	0.015	0.38	0.032	0.81	0.338	8.59	25.7	1.9	66	100	14.2	25.5
<b>C0839A</b>	6	24	7/32	0.015	0.38	0.032	0.81	0.364	9.24	25.7	2.4	66	100	13.2	23.8
<b>C0833A</b>	7	24	7/32	0.015	0.38	0.032	0.81	0.364	9.24	25.7	2.0	66	100	13.2	23.8
<b>C0835A</b>	10	24	7/32	0.015	0.38	0.038	0.97	0.462	11.73	25.7	1.7	66	100	13.2	23.8
<b>C0836A</b>	12	24	7/32	0.015	0.38	0.038	0.97	0.479	12.17	25.7	1.8	66	100	13.2	23.8

\*A – Capacitance between conductors

\*B – Capacitance between one conductor and other conductors connected to shield  
Data subject to change.

**COLOR CODE CHART**

NO. OF COND.	COLOR	NO. OF COND.	COLOR
<b>1</b>	Black paired with Red	<b>7</b>	Black paired with Orange
<b>2</b>	Black paired with White	<b>8</b>	Red paired with White
<b>3</b>	Black paired with Green	<b>9</b>	Red paired with Green
<b>4</b>	Black paired with Blue	<b>10</b>	Red paired with Blue
<b>5</b>	Black paired with Yellow	<b>11</b>	Red paired with Yellow
<b>6</b>	Black paired with Brown	<b>12</b>	Red paired with Brown



# Multi-Paired, Foil/Braid Shield, Lo-Cap®

UL 2919, NEC Type CM (UL) c(UL) CMH

**Product Construction:**

**Conductor:**

- 24 AWG fully annealed stranded tinned copper per ASTM B33
- Twisted pairs

**Insulation:**

- Premium-grade, color-coded Lo-Cap® foamed polypropylene
- Color code: See chart below

**Shield:**

- 100% Flexfoil® aluminum/polyester with 25% overlap, minimum, foil facing out
- Stranded tinned copper drain wire
- 65% tinned copper braid

**Jacket:**

- PVC, gray
- Temperature range: -20°C to +80°C

**Applications:**

- High-speed computer interconnects
- CAD/CAM systems
- EIA RS-232 and RS-423 systems
- Control circuits
- Industrial equipment
- Low signal distortion data requirements
- Suitable for EIA RS-485 120Ω applications

**Compliances:**

- NEC Article 800 Type CM/CMH (UL: 75°C, 300 V)
- UL Style 2919 (UL: 80°C, 30 V)
- RoHS Compliant Directive 2015/863/EU (RoHS-3)

**Packaging:**

- Please contact Customer Service for packaging and color options

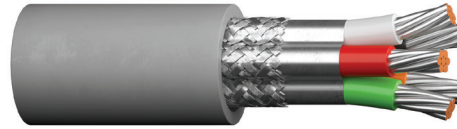

CATALOG NUMBER	NO. OF PAIRS	AWG SIZE	COND. STRAND	NOM. INSULATION THICKNESS		NOM. JACKET THICKNESS		NOMINAL O.D.		NOMINAL DCR Ω/ft	VEL. OF PROP. %	NOM. IMP. Ω	NOMINAL CAP.* pF/ft		
				in	mm	in	mm	in	mm				COND.	SHLD.	A
C0515A	2	24	7/32	0.016	0.41	0.032	0.81	0.276	7.01	25.7	3.0	78	132	10.2	18.4
C0516A	3	24	7/32	0.016	0.41	0.032	0.81	0.290	7.37	25.7	3.2	78	132	9.9	17.8
C0517A	4	24	7/32	0.016	0.41	0.032	0.81	0.315	8.00	25.7	3.3	78	132	9.9	17.8
C0518A	5	24	7/32	0.016	0.41	0.032	0.81	0.340	8.64	25.7	4.2	78	132	9.9	17.8
C0519A	6	24	7/32	0.016	0.41	0.032	0.81	0.368	9.35	25.7	3.6	78	141	9.2	16.6
C0520A	7	24	7/32	0.016	0.41	0.032	0.81	0.370	9.40	25.7	3.5	78	141	9.2	16.6
C0521A	8	24	7/32	0.016	0.41	0.032	0.81	0.397	10.08	25.7	2.7	78	141	9.2	16.6
C0522A	10	24	7/32	0.016	0.41	0.038	0.97	0.473	12.01	25.7	2.4	78	141	9.2	16.6
C0523A	12.5	24	7/32	0.016	0.41	0.038	0.97	0.486	12.34	25.7	2.4	78	141	9.2	16.6
C0524A	15	24	7/32	0.016	0.41	0.048	1.22	0.555	14.10	25.7	2.6	78	141	9.2	16.6
C0525A	18	24	7/32	0.016	0.41	0.048	1.22	0.585	14.86	25.7	2.1	78	141	9.2	16.6
C0526A	25	24	7/32	0.016	0.41	0.048	1.22	0.677	17.20	25.7	2.0	78	141	9.2	16.6

\*A – Capacitance between conductors  
 \*B – Capacitance between one conductor and other conductors connected to shield  
 Data subject to change.

**COLOR CODE CHART**

NO. OF PAIRS	COLOR	NO. OF PAIRS	COLOR	NO. OF PAIRS	COLOR
1	White-Blue Stripe Blue-White Stripe	10	Red-Gray Stripe Gray-Red Stripe	19	Yellow-Brown Stripe Brown-Yellow Stripe
2	White-Orange Stripe Orange-White Stripe	11	Black-Blue Stripe Blue-Black Stripe	20	Yellow-Gray Stripe Gray-Yellow Stripe
3	White-Green Stripe Green-White Stripe	12	Black-Orange Stripe Orange-Black Stripe	21	Purple-Blue Stripe Blue-Purple Stripe
4	White-Brown Stripe Brown-White Stripe	13	Black-Green Stripe Green-Black Stripe	22	Purple-Orange Stripe Orange-Purple Stripe
5	White-Gray Stripe Gray-White Stripe	14	Black-Brown Stripe Brown-Black Stripe	23	Purple-Green Stripe Green-Purple Stripe
6	Red-Blue Stripe Blue-Red Stripe	15	Black-Gray Stripe Gray-Black Stripe	24	Purple-Brown Stripe Brown-Purple Stripe
7	Red-Orange Stripe Orange-Red Stripe	16	Yellow-Blue Stripe Blue-Yellow Stripe	25	Purple-Gray Stripe Gray-Purple Stripe
8	Red-Green Stripe Green-Red Stripe	17	Yellow-Orange Stripe Orange-Yellow Stripe		
9	Red-Brown Stripe Brown-Red Stripe	18	Yellow-Green Stripe Green-Yellow Stripe		

Single Conductor: Green With Yellow Stripe



# Multi-Paired, Individually Foil Shielded

UL 2919, NEC Type CM, CSA CMH

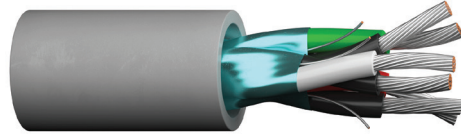

**Product Construction:**

**Conductor:**

- 24 thru 18 AWG fully annealed stranded tinned copper per ASTM B33
- Twisted pairs

**Insulation:**

- Premium-grade, color-coded polyethylene
- Color code: See chart below

**Shield:**

- Individually shielded pairs
- 100% Flexfoil® aluminum/polyester with 25% overlap, minimum, foil facing in
- Stranded tinned copper drain wire each pair

**Jacket:**

- PVC, gray
- Temperature range: -20°C to +80°C

**Applications:**

- Applications for total isolation of signal
- Computers
- Control circuits
- Industrial equipment

**Compliances:**

- NEC Article 800 Type CM (UL: 75°C, 300 V)
- UL Style 2919 (UL: 80°C, 30 V)
- CSA CMH (CSA: 60°C)
- RoHS Compliant Directive 2015/863/EU (RoHS-3)
- Passes CSA CMH Flame Test

**Packaging:**

- Please contact Customer Service for packaging and color options

CATALOG NUMBER	NO. OF PAIRS	AWG SIZE	COND. STRAND	NOM. INSULATION THICKNESS		NOM. JACKET THICKNESS		NOMINAL O.D.		NOMINAL DCR Ω/kft		VEL OF PROP, %	NOM. IMP, Ω	NOMINAL CAP:** pF/ft	
				in	mm	in	mm	in	mm	COND.	SHLD.			A	B
C6065A	3	24	7/32	0.011	0.28	0.032	0.81	0.269	6.83	26.0	18.0	66	71	21.7	39.0
C6066A	6	24	7/32	0.011	0.28	0.032	0.81	0.349	8.86	26.0	18.0	66	71	21.7	39.0
C6067A	9	24	7/32	0.011	0.28	0.032	0.81	0.406	10.31	26.0	18.0	66	71	21.7	39.0
C6040A	3	22	7/30	0.011	0.28	0.032	0.81	0.292	7.42	16.5	11.3	66	63	24.4	43.9
C6041A	6	22	7/30	0.011	0.28	0.032	0.81	0.381	9.68	16.5	11.3	66	63	24.4	43.9
C6042A	9	22	7/30	0.011	0.28	0.032	0.81	0.445	11.30	16.5	11.3	66	63	24.4	43.9
C6043A	11	22	7/30	0.011	0.28	0.032	0.81	0.486	12.34	16.5	11.3	66	63	24.4	43.9
C6059A	12	22	7/30	0.011	0.28	0.048	1.22	0.533	13.54	16.5	11.3	66	63	24.4	43.9
C6044A	15	22	7/30	0.011	0.28	0.048	1.22	0.591	15.01	16.5	11.3	66	63	24.4	43.9
C6060A	17	22	7/30	0.011	0.28	0.048	1.22	0.622	15.80	16.5	11.3	66	63	24.4	43.9
C6045A	19	22	7/30	0.011	0.28	0.048	1.22	0.622	15.80	16.5	11.3	66	63	24.4	43.9
C6046A*	27	22	7/30	0.011	0.28	0.048	1.22	0.696	17.68	16.5	11.3	66	63	24.4	43.9
C6052A	3	20	7/28	0.013	0.33	0.032	0.81	0.339	8.61	10.5	10.2	66	61	25.3	45.6
C6053A	6	20	7/28	0.013	0.33	0.032	0.81	0.446	11.33	10.5	10.2	66	61	25.3	45.6
C6054A	9	20	7/28	0.013	0.33	0.048	1.22	0.555	14.10	10.5	10.2	66	61	25.3	45.6
C6056A	12	20	7/28	0.013	0.33	0.048	1.22	0.623	15.82	10.5	10.2	66	61	25.3	45.6
C6058A	15	20	7/28	0.013	0.33	0.048	1.22	0.692	17.58	10.5	10.2	66	61	25.3	45.6
C6047A	3	18	16/30	0.016	0.41	0.032	0.81	0.395	10.03	7.2	8.3	66	60	25.7	46.2
C6048A	6	18	16/30	0.016	0.41	0.048	1.22	0.556	14.12	7.2	8.3	66	60	25.7	46.2
C6049A	9	18	16/30	0.016	0.41	0.048	1.22	0.649	16.48	7.2	8.3	66	60	25.7	46.2
C6050A	12	18	16/30	0.016	0.41	0.048	1.22	0.731	18.57	7.2	8.3	66	60	25.7	46.2
C6051A	15	18	16/30	0.016	0.41	0.048	1.22	0.776	19.71	7.2	8.3	66	60	25.7	46.2

\*UL 2919, CSA CMH Only

\*\*A – Capacitance between conductors

\*\*B – Capacitance between one conductor and other conductors connected to shield

Data subject to change.

**COLOR CODE CHART**

NO. OF PAIRS	COLOR	NO. OF PAIRS	COLOR	NO. OF PAIRS	COLOR
1	Black paired with Red	10	Red paired with Blue	19	White paired with Blue
2	Black paired with White	11	Red paired with Yellow	20	White paired with Yellow
3	Black paired with Green	12	Red paired with Brown	21	White paired with Brown
4	Black paired with Blue	13	Red paired with Orange	22	White paired with Orange
5	Black paired with Yellow	14	Green paired with White	23	Blue paired with Yellow
6	Black paired with Brown	15	Green paired with Blue	24	Blue paired with Brown
7	Black paired with Orange	16	Green paired with Yellow	25	Blue paired with Orange
8	Red paired with White	17	Green paired with Brown	26	Brown paired with Yellow
9	Red paired with Green	18	Green paired with Orange	27	Brown paired with Orange



# Multi-Paired, Individually Foil Shielded, Lo-Cap®

UL 2493, NEC Type CM (UL) c(UL) CMH

**Product Construction:**

**Conductor:**

- 24 AWG fully annealed stranded tinned copper per ASTM B33
- Twisted pairs

**Insulation:**

- Premium-grade, color-coded foamed Lo-Cap® polypropylene
- Color code: See chart below

**Shield:**

- Individually shielded pairs
- 100% Flexfoil® aluminum/polyester with 25% overlap, minimum, foil facing in
- Stranded tinned copper drain wire each pair

**Jacket:**

- PVC, gray
- Temperature range: -20°C to +75°C

**Applications:**

- High-speed computers
- Industrial equipment
- Control circuits
- Suitable for low capacitance applications
- Suitable for EIA RS-422 CAD/CAM applications
- Suggested voltage rating: 300 volts

**Compliances:**

- NEC Article 800 Type CM/CMH (UL: 75°C, 300 V)
- UL Style 2493 (UL: 60°C)
- RoHS Compliant Directive 2015/863/EU (RoHS-3)

**Packaging:**

- Please contact Customer Service for packaging and color options

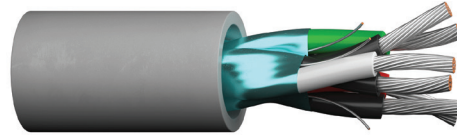

CATALOG NUMBER	NO. OF PAIRS	AWG SIZE	COND. STRAND	NOM. INSULATION THICKNESS		NOM. JACKET THICKNESS		NOMINAL O.D.		NOMINAL DCR Ω/kft		VEL. OF PROP. %	NOM. IMP. Ω	NOMINAL CAP.* pF/ft	
				in	mm	in	mm	in	mm	COND.	SHLD.			A	B
C0910A	2	24	7/32	0.022	0.56	0.047	1.19	0.283	7.19	26.0	18.0	78	100	14.8	26.7
C0911A	3	24	7/32	0.022	0.56	0.048	1.22	0.381	9.68	26.0	18.0	78	100	14.8	26.7
C0912A	4	24	7/32	0.022	0.56	0.048	1.22	0.416	10.57	26.0	18.0	78	100	14.8	26.7
C0913A	6	24	7/32	0.022	0.56	0.048	1.22	0.492	12.50	26.0	18.0	78	100	14.8	26.7
C0914A	9	24	7/32	0.022	0.56	0.063	1.60	0.601	15.27	26.0	18.0	78	100	14.8	26.7
C0915A	11	24	7/32	0.022	0.56	0.063	1.60	0.652	16.56	26.0	18.0	78	100	14.8	26.7
C0916A	12	24	7/32	0.022	0.56	0.063	1.60	0.672	17.08	26.0	18.0	78	100	14.8	26.7
C0917A	15	24	7/32	0.022	0.56	0.063	1.60	0.743	18.87	26.0	18.0	78	100	14.8	26.7

\*A – Capacitance between conductors

\*B – Capacitance between one conductor and other conductors connected to shield  
Data subject to change.

**COLOR CODE CHART**

NO. OF COND.	COLOR	NO. OF COND.	COLOR	NO. OF COND.	COLOR
1	Black paired with Red	6	Black paired with Brown	11	Red paired with Yellow
2	Black paired with White	7	Black paired with Orange	12	Red paired with Brown
3	Black paired with Green	8	Red paired with White	13	Red paired with Orange
4	Black paired with Blue	9	Red paired with Green	14	Green paired with White
5	Black paired with Yellow	10	Red paired with Blue	15	Green paired with Blue



# Multi-Paired, Individually Foil/Braid Shielded, Lo-Cap®

UL 2493, NEC Type CM (UL) c(UL) CMH

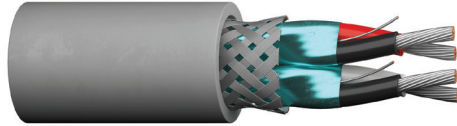

CATALOG NUMBER	NO. OF PAIRS	AWG SIZE	COND. STRAND	NOM. INSULATION THICKNESS		NOM. JACKET THICKNESS		NOMINAL O.D.		NOMINAL DCR**			VEL. OF PROP. %	NOM. IMP. Ω	NOMINAL CAP.*	
				in	mm	in	mm	in	mm	C	D	E			A	B
<b>C0924A</b>	2	24	7/32	0.022	0.56	0.048	1.22	0.392	9.96	26.0	18.0	4.3	78	100	14.8	26.7
<b>C0925A</b>	3	24	7/32	0.022	0.56	0.048	1.22	0.410	10.41	26.0	18.0	4.4	78	100	14.8	26.7
<b>C0926A</b>	4	24	7/32	0.022	0.56	0.048	1.22	0.445	11.30	26.0	18.0	3.2	78	100	14.8	26.7

\*A – Capacitance between conductors  
 \*B – Capacitance between one conductor and other conductors connected to shield  
 \*\*C – Conductor resistance  
 \*\*D – Individual shield resistance  
 \*\*E – Overall shield resistance  
 Data subject to change.

### COLOR CODE CHART

NO. OF PAIRS	COLOR
<b>1</b>	Black paired with Red
<b>2</b>	Black paired with White
<b>3</b>	Black paired with Green
<b>4</b>	Black paired with Blue

### Product Construction:

#### Conductor:

- 24 AWG fully annealed stranded tinned copper per ASTM B33
- Twisted pairs

#### Insulation:

- Premium-grade, color-coded foamed Lo-Cap® polypropylene
- Color code: See chart below

#### Shield:

- Individually shielded pairs
- 100% Flexfoil® aluminum/polyester with 25% overlap, minimum, foil facing in
- Stranded tinned copper drain wire, each pair
- 70% tinned copper braid

#### Jacket:

- PVC, gray
- Temperature range: -20°C to +75°C

### Applications:

- High-speed computers
- Industrial equipment
- Control circuits
- Designed for low capacitance applications
- Suitable for RS-422 CAD/CAM applications
- Suggested voltage rating: 300 volts

### Compliances:

- NEC Article 800 Type CM/CMH (UL: 75°C, 300 V)
- UL Style 2493 (UL: 60°C)
- RoHS Compliant Directive 2015/863/EU (RoHS-3)

### Packaging:

- Please contact Customer Service for packaging and color options



# EXZEL® High-Endurance Cables

## 4



As a full electronics solutions provider with a commitment to designing innovative cable constructions, Prysmian recognizes the growing demand for a higher performance line of electronic wire and cable to support emerging technology, mission-critical applications and today's environmental concerns. That's why we've introduced a new, tougher addition to the CAROL® Brand family – EXZEL High-Endurance Electronic Cables.

Prysmian's new EXZEL High-Endurance Electronic Cables are engineered for extreme environments where unparalleled performance is critical and cable failures are not an option. An exceptional choice that offers complete peace of mind, this new cabling line excels in applications where oil, liquids, vapors or other substances can attack the jacketing of conventional "round gray" PVC electronic cables. Along with improved jacketing performance, EXZEL's innovative Dual Foil/Braid Shield technology provides more effective shielding. This dual-foil design with 85% copper-braid coverage significantly reduces electromagnetic and radio frequency interference (EMI/RFI) over traditional single-foil tape designs.

In response to environmental concern surrounding the burning of halogens, Prysmian also offers the Low-Smoke, Zero-Halogen (LSZH) line of EXZEL High-Endurance Electronic Cables. To reduce the toxicity and corrosive effects that may impact people and equipment, CAROL Brand's EXZEL LSZH construction produces low amounts of smoke and acid gas during a fire, while maintaining the same flame requirements, electrical performance and longevity as traditional cable constructions.

Whether you are involved with a green building installation or simply looking for ways to safeguard people and protect the environment, EXZEL High-Endurance Electronic Cables provide a true "green" alternative. And with EXZEL, U.S. manufacturers now have access to a domestic LSZH cable solution required for use on equipment that may be sold internationally.

Section	Page
CAROL Brand EXZEL Guide	60-62
Multi-Conductor, Unshielded	63
Multi-Conductor, Foil Shielded	64
Multi-Conductor, Foil/Braid Shielded	65
Multi-Paired, Unshielded	66
Multi-Paired, Foil Shielded	67
Multi-Paired, Foil/Braid Shielded	68
Multi-Conductor, Unshielded, Heavy Duty	69
Multi-Conductor, Foil Shielded, Heavy Duty	70
Multi-Conductor, Foil/Braid Shielded, Heavy Duty	71
Multi-Paired, Foil/Braid Shielded, Heavy Duty	72
LSZH Multi-Conductor, Unshielded	73
LSZH Multi-Conductor, Foil Shielded	74
LSZH Multi-Conductor, Foil/Braid Shielded	75
LSZH Multi-Paired, Unshielded	76
LSZH Multi-Paired, Foil Shielded	77
LSZH Multi-Paired, Foil/Braid Shielded	78
Color Code Charts	79

# CAROL® Brand EXZEL® Complete Peace of Mind

## READY TO SERVE

For more than 60 years, Prysmian has met the ever-changing needs of major Original Equipment Manufacturers (OEMs) and the most demanding, high-volume bulk requirements of Maintenance Repair Operations (MROs), as well as smaller, niche OEMs around the world. Uniquely qualified to provide superior engineering, products and value-added services, Prysmian's customers represent a virtual "who's who" of the industries we serve. All CAROL® Brand's EXZEL® High-Endurance Electronic Cables are ideal for use in the following markets and applications:

### Manufacturing

- Device communications
- Control interconnect
- PLC networking
- Industrial machinery

### Food and Beverage

- Meat and food processing
- Bottling plants
- Packaging machines

### Semiconductor

- Robotic handling systems
- Class I, Division 2
- Automated test equipment
- Wafer processing equipment

### Utilities

- Wastewater treatment plants
- Wind turbine control
- Gas delivery communications

### Military

- Mobile communications
- Avionics control

### Process

- Remote monitoring
- Discrete/analog signaling

### Medical Diagnostics

- Digital imaging control
- Biomedical

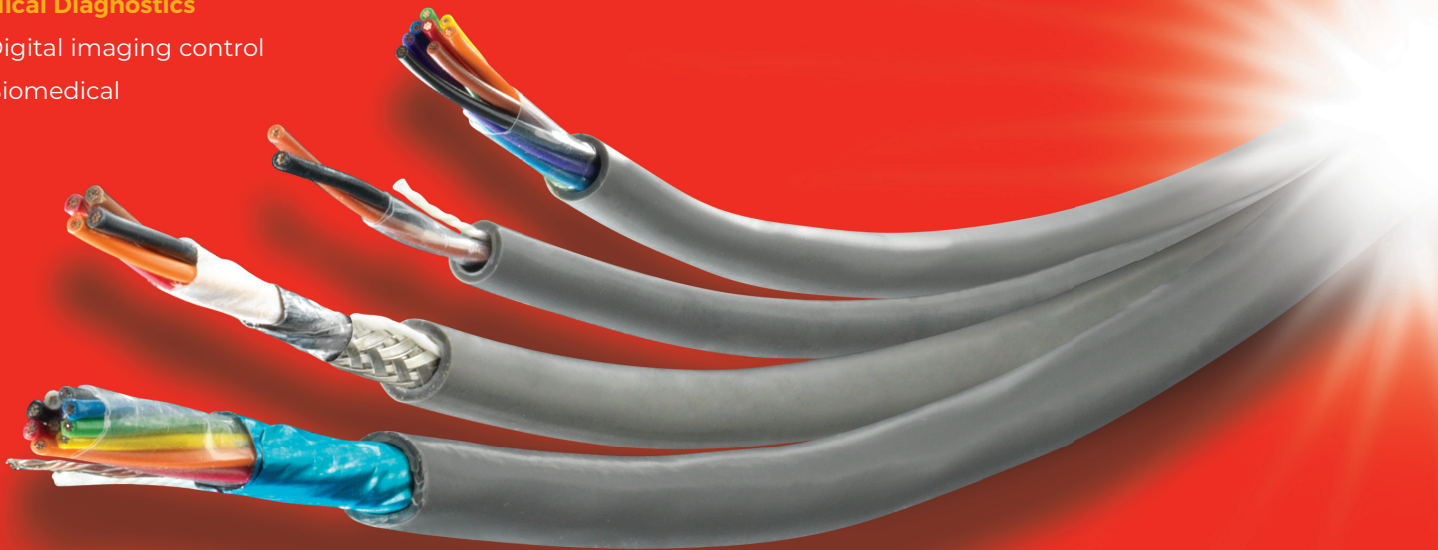

**BACKED BY QUALITY**

EXZEL® High-Endurance Electronic Cables are manufactured with the selection, quality and dependability our customers have come to expect from CAROL® Brand cables. From special jacket colors, print legends and TRU-Mark® sequential footage markings to unique constructions, innovative materials and quality manufacturing, Prysmian's expert engineers offer superior service and design assistance. Most of our products carry UL, ETL, RoHS, CSA and other major approvals from around the globe.

Need a specific construction not available in our standard stock? We have you covered. Prysmian will customize any standard EXZEL cable construction to meet your unique application requirements, including:

- Jacket colors
- Gauge sizes
- Conductor count and construction
- Insulation and jacket construction
- Shielding options
- Armoring
- Composites

EXZEL's LSZH cables, as well as all of our High-Endurance cables, are manufactured in Prysmian's Franklin, Massachusetts and Manchester, New Hampshire facilities — both of which are recognized among North America's Top 10 Best Manufacturing Plants by INDUSTRYWEEK Magazine.

When exceptional performance and reliability are critical to your application, put your trust in CAROL Brand EXZEL.

**Comparison of Traditional Round Gray Electronic Cables to EXZEL High-Endurance Electronic Cables**

	Traditional Round Gray Electronic Cables	EXZEL PVC	EXZEL LSZH
<b>Conductor Type</b>	Tinned Copper	Tinned Copper	Tinned Copper
<b>Conductor Strand</b>	7/XX	Flexible	Flexible
<b>Insulation</b>	PVC	PVC	LSZH
<b>Shielding</b>	Limited	Full	Full
<b>Braid Coverage</b>	70	70	85
<b>Jacket</b>	PVC	PVC	LSZH
<b>Footage Markings</b>	No	TRU-Mark	Yes
<b>Temp Rating</b>	80 °C	105 °C	105 °C
<b>Oil Resistance</b>	No	No	OR I*
<b>UV Resistance</b>	No	Yes	Yes
<b>NEC/UL Type CM</b>	Yes (80 °C)	Yes (105 °C)	Yes
<b>UL AWM</b>	Style 2464	Style 2464	N/A
<b>CSA CMG</b>	Yes (80 °C)	Yes (105 °C)	No
<b>UL PLTC-ER</b>	No	No	Yes
<b>PLTC</b>	No	No	Yes
<b>UL Flame Rating</b>	UL 1581	UL 1581	UL 1581
<b>CSA Flame Rating</b>	FT4	FT4	FT4

\*OR I = UL Oil Resistance I

**FEATURES AND BENEFITS OF CAROL<sup>®</sup> BRAND EXZEL<sup>®</sup>**

- Reduced downtime for lower cost of ownership
- Superior reliability, even in the harshest environments available
- Extensive selection to meet application needs
- Optimum lifespan in severe operating conditions
- Highest available shield coverage for maximum EMI/RFI resistance
- Low-Smoke, Zero-Halogen constructions available
- Premium-grade PVC insulation and jacket available for routing in tight spaces
- Resistant to most oils (UL Class 43) and to ambient temperatures up to 105°C

**SURFACE TRANSFER IMPEDANCES (STI)**

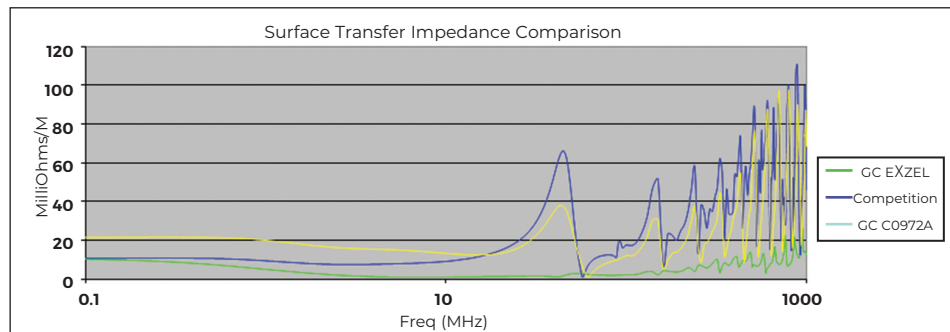

## Why Prysmian?

**Unrivaled service. Unparalleled innovation. Unmatched industry leadership.**

At Prysmian, we believe quality is what we put in your product. That's why we employ a LeanSigma management philosophy that eliminates waste and non-value-added processes to improve the flow of information and materials. Always searching for new and better ways of doing things, Prysmian consistently identifies and eliminates sources of variation while reducing cycle time and inventory, ensuring better capacity and space utilization and improving productivity. We have the right mix of people, equipment and experience to produce custom cables, wire harnesses and cable assemblies of the highest complexity and quality

- High-Endurance Electronic products that exzel!
- Certified ISO 9001 manufacturing facilities
- Rigorous performance standards
- Ongoing R&D for an ever-growing range of materials
- Superior materials and proactive prevention
- Comprehensive process control and quality audits
- Stringent in-house and third-party testing

Prysmian is an environmentally conscious company committed to reducing and, where possible, eliminating hazardous substances. Our facilities have fully implemented an ISO 14001-equivalent environmental management system with strict oversight to ensure that regulatory compliance is met or exceeded. All applicable products are certified or are being upgraded to meet RoHS standards, and we are working to comply with evolving REACH requirements as they pertain to wire and cable products and materials.

**THE BOTTOM LINE**

Prysmian recognizes and values the vital importance of total, exceptional customer satisfaction, and we have the experience and know-how to achieve it. Our people may come to work for us, but on the job, our Wire Wizards work for you. Put us to work and see what we can do for you.

# EXZEL® Multi-Conductor, Unshielded

UL 2464, NEC Type CM (UL), CSA CMG

**Product Construction:**

**Conductor:**

- Fully annealed stranded tinned copper per ASTM B33

**Insulation:**

- Premium-grade, color-coded PVC
- Color per Chart A for 24 AWG and 22 AWG on page 97
- Color per Chart B for 20 AWG and larger on page 97
- International colors per IEC Color Chart on page 97

**Shield:**

- Unshielded

**Jacket:**

- Premium PVC
- Operating temperature range:  
-30°C to +105°C (Type CM)  
-30°C to +80°C (AWM)

**Applications:**

- Advanced signal transmission in controlled environments
- Medical instrumentation and equipment
- Consumer electronic peripherals
- Industrial process control systems
- Suitable for EIA RS-232 applications

**Features:**

- Oil-resistant per UL Oil Res I and Class 43
- Sunlight-resistant per UL 720-hr. UV test
- Nylon ripcord

**Compliances:**

- NEC Article 800 Type CM (UL: 105°C)
- UL Style 2464 (UL: 80°C, 300 V, VW-1)
- CSA Type CMG (CSA: 105°C, FT4)
- RoHS Compliant Directive 2015/863/EU (RoHS-3)
- Vertical Tray Cable Flame Test per UL 1581 and IEEE 383 (70,000 BTU)

**Packaging**

- Please contact Customer Service for packaging and color options
- Data subject to change.

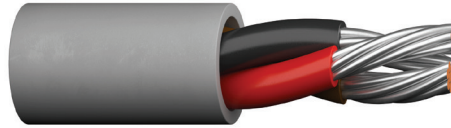

PART NUMBER	COND.	AWG SIZE	COND. STRAND	NOMINAL INSULATION THICKNESS		NOMINAL JACKET THICKNESS		NOMINAL CABLE DIAMETER	
				in	mm	in	mm	INCHES	mm
C9000A	2	24	7/32	0.010	0.25	0.032	0.81	0.155	3.94
C9001A	3	24	7/32	0.010	0.25	0.032	0.81	0.161	4.10
C9002A	4	24	7/32	0.010	0.25	0.032	0.81	0.173	4.40
C9003A	6	24	7/32	0.010	0.25	0.032	0.81	0.198	5.03
C9004A	8	24	7/32	0.010	0.25	0.032	0.81	0.211	5.37
C9005A	10	24	7/32	0.010	0.25	0.032	0.81	0.241	6.12
C9006A	15	24	7/32	0.010	0.25	0.032	0.81	0.271	6.89
C9007A	20	24	7/32	0.010	0.25	0.032	0.81	0.297	7.55
C9008A	25	24	7/32	0.010	0.25	0.032	0.81	0.327	8.31
C9009A	2	22	7/30	0.010	0.25	0.032	0.81	0.167	4.24
C9010A	3	22	7/30	0.010	0.25	0.032	0.81	0.174	4.43
C9011A	4	22	7/30	0.010	0.25	0.032	0.81	0.188	4.76
C9012A	6	22	7/30	0.010	0.25	0.032	0.81	0.216	5.49
C9013A	8	22	7/30	0.010	0.25	0.032	0.81	0.231	5.87
C9014A	10	22	7/30	0.010	0.25	0.032	0.81	0.265	6.73
C9015A	15	22	7/30	0.010	0.25	0.032	0.81	0.299	7.60
C9016A	20	22	7/30	0.010	0.25	0.032	0.81	0.329	8.36
C9017A	25	22	7/30	0.010	0.25	0.032	0.81	0.363	9.22
C9018A	2	20	7/28	0.016	0.41	0.032	0.81	0.205	5.21
C9019A	3	20	7/28	0.016	0.41	0.032	0.81	0.215	5.47
C9020A	4	20	7/28	0.016	0.41	0.032	0.81	0.234	5.93
C9021A	6	20	7/28	0.016	0.41	0.032	0.81	0.273	6.93
C9022A	8	20	7/28	0.016	0.41	0.032	0.81	0.294	7.47
C9023A	10	20	7/28	0.016	0.41	0.032	0.81	0.341	8.66
C9024A	15	20	7/28	0.016	0.41	0.032	0.81	0.389	9.87
C9025A	20	20	7/28	0.016	0.41	0.032	0.81	0.430	10.92
C9026A	25	20	7/28	0.016	0.41	0.032	0.81	0.477	12.12
C9027A*	2	18	16/30	0.016	0.41	0.032	0.81	0.225	5.72
C9028A	2	18	16/30	0.016	0.41	0.032	0.81	0.225	5.72
C9029A*	3	18	16/30	0.016	0.41	0.032	0.81	0.237	6.01
C9030A	3	18	16/30	0.016	0.41	0.032	0.81	0.237	6.01
C9031A	4	18	16/30	0.016	0.41	0.032	0.81	0.258	6.55
C9032A	6	18	16/30	0.016	0.41	0.032	0.81	0.303	7.70
C9033A	8	18	16/30	0.016	0.41	0.032	0.81	0.327	8.31
C9034A	10	18	16/30	0.016	0.41	0.032	0.81	0.381	9.68
C9035A	15	18	16/30	0.016	0.41	0.032	0.81	0.436	11.06
C9036A	20	18	16/30	0.016	0.41	0.032	0.81	0.483	12.27
C9037A	25	18	16/30	0.016	0.41	0.032	0.81	0.537	13.64
C9038A*	2	16	19/0117	0.016	0.41	0.032	0.81	0.245	6.22
C9039A	2	16	19/0117	0.016	0.41	0.032	0.81	0.245	6.22
C9040A*	3	16	19/0117	0.016	0.41	0.032	0.81	0.258	6.56
C9041A	3	16	19/0117	0.016	0.41	0.032	0.81	0.258	6.56
C9042A	4	16	19/0117	0.016	0.41	0.032	0.81	0.282	7.16
C9043A	6	16	19/0117	0.016	0.41	0.032	0.81	0.333	8.46
C9044A	8	16	19/0117	0.016	0.41	0.032	0.81	0.360	9.15
C9045A	10	16	19/0117	0.016	0.41	0.032	0.81	0.421	10.69
C9046A	15	16	19/0117	0.016	0.41	0.032	0.81	0.483	12.26
C9047A	20	16	19/0117	0.016	0.41	0.053	1.35	0.578	14.69
C9048A	25	16	19/0117	0.016	0.41	0.053	1.35	0.639	16.23

\* IEC Color Code: Brown, Blue, Green/Yellow



# EXZEL® Multi-Conductor, Foil Shielded

UL 2464, NEC Type CM (UL), CSA CMG

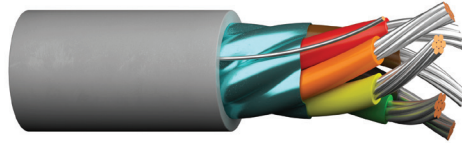

**Product Construction:**

**Conductor:**

- Fully annealed stranded tinned copper per ASTM B33

**Insulation:**

- Premium-grade, color-coded PVC
- Color per Chart A for 24 AWG and 22 AWG on page 97
- Color per Chart B for 20 AWG and larger on page 97
- International colors per IEC Color Chart on page 97

**Shield:**

- 100% Flexfoil® aluminum/polyester, foil facing in
- Stranded tinned copper drain wire

**Jacket:**

- Premium PVC
- Operating temperature range: -30°C to +105°C (Type CM)
- -30°C to +80°C (AWM)

**Applications:**

- Advanced signal transmission in controlled environments
- Medical instrumentation and equipment
- Consumer electronic peripherals
- Industrial process control systems
- Suitable for EIA RS-232 applications

**Features:**

- Oil-resistant per UL Oil Res I and Class 43
- Sunlight-resistant per UL 720-hr. UV test
- Nylon ripcord

**Compliances:**

- NEC Article 800 Type CM (UL: 105°C)
- UL Style 2464 (UL: 80°C, 300 V, VW-1)
- CSA Type CMG (CSA: 105°C, FT4)
- RoHS Compliant Directive 2015/863/EU (RoHS-3)
- Vertical Tray Cable Flame Test per UL 1581 and IEEE 383 (70,000 BTU)

**Packaging:**

- Please contact Customer Service for packaging and color options
- Data subject to change.

PART NUMBER	COND.	AWG SIZE	COND. STRAND	NOMINAL INSULATION THICKNESS		NOMINAL JACKET THICKNESS		NOMINAL CABLE DIAMETER	
				in	mm	in	mm	in	mm
C9100A	2	24	7/32	0.010	0.25	0.032	0.81	0.157	3.99
C9101A	3	24	7/32	0.010	0.25	0.032	0.81	0.163	4.15
C9102A	4	24	7/32	0.010	0.25	0.032	0.81	0.175	4.45
C9103A	6	24	7/32	0.010	0.25	0.032	0.81	0.200	5.08
C9104A	8	24	7/32	0.010	0.25	0.032	0.81	0.213	5.42
C9105A	10	24	7/32	0.010	0.25	0.032	0.81	0.243	6.17
C9106A	15	24	7/32	0.010	0.25	0.032	0.81	0.273	6.94
C9107A	20	24	7/32	0.010	0.25	0.032	0.81	0.299	7.60
C9108A	25	24	7/32	0.010	0.25	0.032	0.81	0.329	8.36
C9109A	2	22	7/30	0.010	0.25	0.032	0.81	0.169	4.29
C9110A	3	22	7/30	0.010	0.25	0.032	0.81	0.176	4.48
C9111A	4	22	7/30	0.010	0.25	0.032	0.81	0.190	4.82
C9112A	6	22	7/30	0.010	0.25	0.032	0.81	0.218	5.54
C9113A	8	22	7/30	0.010	0.25	0.032	0.81	0.233	5.92
C9114A	10	22	7/30	0.010	0.25	0.032	0.81	0.267	6.78
C9115A	15	22	7/30	0.010	0.25	0.032	0.81	0.301	7.65
C9116A	20	22	7/30	0.010	0.25	0.032	0.81	0.331	8.41
C9117A	25	22	7/30	0.010	0.25	0.032	0.81	0.365	9.27
C9118A	2	20	7/28	0.016	0.41	0.032	0.81	0.207	5.26
C9119A	3	20	7/28	0.016	0.41	0.032	0.81	0.217	5.52
C9120A	4	20	7/28	0.016	0.41	0.032	0.81	0.236	5.98
C9121A	6	20	7/28	0.016	0.41	0.032	0.81	0.275	6.99
C9122A	8	20	7/28	0.016	0.41	0.032	0.81	0.296	7.52
C9123A	10	20	7/28	0.016	0.41	0.032	0.81	0.343	8.71
C9124A	15	20	7/28	0.016	0.41	0.032	0.81	0.391	9.92
C9125A	20	20	7/28	0.016	0.41	0.032	0.81	0.432	10.97
C9126A	25	20	7/28	0.016	0.41	0.032	0.81	0.479	12.17
C9127A	2	18	16/30	0.016	0.41	0.032	0.81	0.227	5.77
C9128A*	2	18	16/30	0.016	0.41	0.032	0.81	0.227	5.77
C9129A	3	18	16/30	0.016	0.41	0.032	0.81	0.239	6.06
C9130A*	3	18	16/30	0.016	0.41	0.032	0.81	0.239	6.06
C9131A	4	18	16/30	0.016	0.41	0.032	0.81	0.260	6.60
C9132A	6	18	16/30	0.016	0.41	0.032	0.81	0.305	7.75
C9133A	8	18	16/30	0.016	0.41	0.032	0.81	0.329	8.36
C9134A	10	18	16/30	0.016	0.41	0.032	0.81	0.383	9.73
C9135A	15	18	16/30	0.016	0.41	0.032	0.81	0.438	11.12
C9136A	20	18	16/30	0.016	0.41	0.032	0.81	0.485	12.32
C9137A	25	18	16/30	0.016	0.41	0.032	0.81	0.539	13.69
C9138A	2	16	19/0117	0.016	0.41	0.032	0.81	0.247	6.27
C9139A*	2	16	19/0117	0.016	0.41	0.032	0.81	0.247	6.27
C9140A	3	16	19/0117	0.016	0.41	0.032	0.81	0.260	6.61
C9141A*	3	16	19/0117	0.016	0.41	0.032	0.81	0.260	6.61
C9142A	4	16	19/0117	0.016	0.41	0.032	0.81	0.284	7.21
C9143A	6	16	19/0117	0.016	0.41	0.032	0.81	0.335	8.51
C9144A	8	16	19/0117	0.016	0.41	0.032	0.81	0.362	9.20
C9145A	10	16	19/0117	0.016	0.41	0.032	0.81	0.423	10.74
C9146A	15	16	19/0117	0.016	0.41	0.032	0.81	0.485	12.31
C9147A	20	16	19/0117	0.016	0.41	0.053	1.35	0.580	14.74
C9148A	25	16	19/0117	0.016	0.41	0.053	1.35	0.641	16.28

\* IEC Color Code: Brown, Blue, Green/Yellow



# EXZEL® Multi-Conductor, Foil/Braid Shielded

UL 2464, NEC Type CM (UL), CSA CMG

**Product Construction:**

**Conductor:**

- Fully annealed stranded tinned copper per ASTM B33

**Insulation:**

- Premium-grade, color-coded PVC
- Color per Chart A for 24 AWG and 22 AWG on page 97
- Color per Chart B for 20 AWG and larger on page 97
- International colors per IEC Color Chart on page 97

**Shield:**

- Dual foil with overall braided shield
- Aluminum/polyester/aluminum foil with 100% coverage
- Stranded tinned copper drain wire
- Tinned copper braided shield, 70% min coverage

**Jacket:**

- Premium PVC
- Operating temperature range: -30°C to +105°C (Type CM)
- -30°C to +80°C (AWM)

**Applications:**

- Advanced signal transmission in controlled environments
- Medical instrumentation and equipment
- Consumer electronic peripherals
- Industrial process control systems
- Suitable for EIA RS-232 applications

**Features:**

- Oil-resistant per UL Oil Res I and Class 43
- Sunlight-resistant
- Nylon ripcord

**Compliances:**

- NEC Article 800 Type CM (UL: 105°C)
- UL Style 2464 (UL: 80°C, 300 V, VW-1)
- CSA Type CMG (CSA: 105°C, FT4)
- RoHS Compliant Directive 2015/863/EU (RoHS-3)
- Vertical Tray Cable Flame Test per UL 1581 and IEEE 383 (70,000 BTU)

**Packaging:**

- Please contact Customer Service for packaging and color options
- Data subject to change.

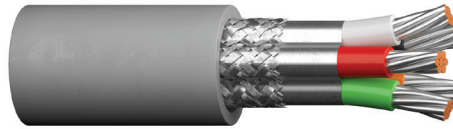

PART NUMBER	COND.	AWG SIZE	COND. STRAND	NOMINAL INSULATION THICKNESS		NOMINAL JACKET THICKNESS		NOMINAL CABLE DIAMETER	
				in	mm	in	mm	in	mm
C9200A	2	24	7/32	0.010	0.25	0.032	0.81	0.184	4.67
C9201A	3	24	7/32	0.010	0.25	0.032	0.81	0.190	4.84
C9202A	4	24	7/32	0.010	0.25	0.032	0.81	0.202	5.13
C9203A	6	24	7/32	0.010	0.25	0.032	0.81	0.227	5.77
C9204A	8	24	7/32	0.010	0.25	0.032	0.81	0.240	6.10
C9205A	10	24	7/32	0.010	0.25	0.032	0.81	0.270	6.86
C9206A	15	24	7/32	0.010	0.25	0.032	0.81	0.300	7.62
C9207A	20	24	7/32	0.010	0.25	0.032	0.81	0.326	8.29
C9208A	25	24	7/32	0.010	0.25	0.032	0.81	0.356	9.04
C9209A	2	22	7/30	0.010	0.25	0.032	0.81	0.196	4.98
C9210A	3	22	7/30	0.010	0.25	0.032	0.81	0.203	5.17
C9211A	4	22	7/30	0.010	0.25	0.032	0.81	0.217	5.50
C9212A	6	22	7/30	0.010	0.25	0.032	0.81	0.245	6.22
C9213A	8	22	7/30	0.010	0.25	0.032	0.81	0.260	6.61
C9214A	10	22	7/30	0.010	0.25	0.032	0.81	0.294	7.47
C9215A	15	22	7/30	0.010	0.25	0.032	0.81	0.328	8.34
C9216A	20	22	7/30	0.010	0.25	0.032	0.81	0.358	9.10
C9217A	25	22	7/30	0.010	0.25	0.032	0.81	0.392	9.96
C9218A	2	20	7/28	0.016	0.41	0.032	0.81	0.234	5.94
C9219A	3	20	7/28	0.016	0.41	0.032	0.81	0.244	6.20
C9220A	4	20	7/28	0.016	0.41	0.032	0.81	0.263	6.67
C9221A	6	20	7/28	0.016	0.41	0.032	0.81	0.302	7.67
C9222A	8	20	7/28	0.016	0.41	0.032	0.81	0.323	8.21
C9223A	10	20	7/28	0.016	0.41	0.032	0.81	0.370	9.40
C9224A	15	20	7/28	0.016	0.41	0.032	0.81	0.418	10.61
C9225A	20	20	7/28	0.016	0.41	0.032	0.81	0.459	11.66
C9226A	25	20	7/28	0.016	0.41	0.032	0.81	0.506	12.85
C9227A*	2	18	16/30	0.016	0.41	0.032	0.81	0.254	6.45
C9228A	2	18	16/30	0.016	0.41	0.032	0.81	0.254	6.45
C9229A*	3	18	16/30	0.016	0.41	0.032	0.81	0.266	6.75
C9230A	3	18	16/30	0.016	0.41	0.032	0.81	0.266	6.75
C9231A	4	18	16/30	0.016	0.41	0.032	0.81	0.287	7.28
C9232A	6	18	16/30	0.016	0.41	0.032	0.81	0.332	8.43
C9233A	8	18	16/30	0.016	0.41	0.032	0.81	0.356	9.05
C9234A	10	18	16/30	0.016	0.41	0.032	0.81	0.410	10.41
C9235A	15	18	16/30	0.016	0.41	0.032	0.81	0.465	11.80
C9236A	20	18	16/30	0.016	0.41	0.032	0.81	0.512	13.01
C9237A	25	18	16/30	0.016	0.41	0.032	0.81	0.566	14.38
C9238A*	2	16	19/0117	0.016	0.41	0.032	0.81	0.274	6.96
C9239A	2	16	19/0117	0.016	0.41	0.032	0.81	0.274	6.96
C9240A*	3	16	19/0117	0.016	0.41	0.032	0.81	0.287	7.29
C9241A	3	16	19/0117	0.016	0.41	0.032	0.81	0.287	7.29
C9242A	4	16	19/0117	0.016	0.41	0.032	0.81	0.311	7.90
C9243A	6	16	19/0117	0.016	0.41	0.032	0.81	0.362	9.19
C9244A	8	16	19/0117	0.016	0.41	0.032	0.81	0.389	9.89
C9245A	10	16	19/0117	0.016	0.41	0.032	0.81	0.450	11.43
C9246A	15	16	19/0117	0.016	0.41	0.032	0.81	0.512	12.99
C9247A	20	16	19/0117	0.016	0.41	0.053	1.35	0.607	15.42
C9248A	25	16	19/0117	0.016	0.41	0.053	1.35	0.679	17.25

\* IEC Color Code: Brown, Blue, Green/Yellow



# EXZEL® Multi-Paired, Unshielded

UL 2464, NEC Type CM (UL), CSA CMG

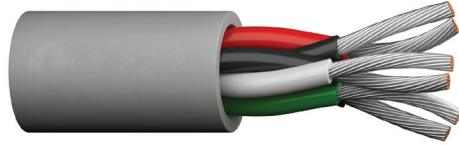

PART NUMBER	PAIRS	AWG SIZE	COND. STRAND	NOMINAL INSULATION THICKNESS		NOMINAL JACKET THICKNESS		NOMINAL CABLE DIAMETER	
				in	mm	in	mm	in	mm
C9300A	1	24	7/32	0.010	0.25	0.032	0.81	0.155	3.94
C9301A	2	24	7/32	0.010	0.25	0.032	0.81	0.211	5.37
C9302A	3	24	7/32	0.010	0.25	0.032	0.81	0.222	5.64
C9303A	4	24	7/32	0.010	0.25	0.032	0.81	0.242	6.13
C9304A	5	24	7/32	0.010	0.25	0.032	0.81	0.262	6.65
C9305A	6	24	7/32	0.010	0.25	0.032	0.81	0.283	7.20
C9306A	9	24	7/32	0.010	0.25	0.032	0.81	0.327	8.31
C9307A	11	24	7/32	0.010	0.25	0.032	0.81	0.355	9.03
C9308A	15	24	7/32	0.010	0.25	0.032	0.81	0.406	10.31
C9309A	1	22	7/30	0.010	0.25	0.032	0.81	0.149	3.79
C9310A	2	22	7/30	0.010	0.25	0.032	0.81	0.231	5.88
C9311A	3	22	7/30	0.010	0.25	0.032	0.81	0.244	6.19
C9312A	4	22	7/30	0.010	0.25	0.032	0.81	0.266	6.75
C9313A	5	22	7/30	0.010	0.25	0.032	0.81	0.289	7.34
C9314A	6	22	7/30	0.010	0.25	0.032	0.81	0.314	7.96
C9315A	15	22	7/30	0.010	0.25	0.032	0.81	0.453	11.51
C9316A	2	20	7/28	0.016	0.41	0.032	0.81	0.295	7.49
C9317A	3	20	7/28	0.016	0.41	0.032	0.81	0.312	7.93
C9318A	6	20	7/28	0.016	0.41	0.032	0.81	0.409	10.39
C9319A	9	20	7/28	0.016	0.41	0.032	0.81	0.479	12.16
C9320A	12	20	7/28	0.016	0.41	0.032	0.81	0.540	13.72
C9321A	2	18	16/30	0.016	0.41	0.032	0.81	0.329	8.35
C9322A	3	18	16/30	0.016	0.41	0.032	0.81	0.348	8.85
C9323A	6	18	16/30	0.016	0.41	0.032	0.81	0.459	11.67
C9324A	9	18	16/30	0.016	0.41	0.032	0.81	0.539	13.70
C9325A	12	18	16/30	0.016	0.41	0.053	1.35	0.652	16.56

**Product Construction:**

**Conductor:**

- Fully annealed stranded tinned copper per ASTM B33

**Insulation:**

- Premium-grade, color-coded PVC
- Color per Chart C for 24 AWG and 22 AWG on page 97
- Color per Chart D for 20 AWG and larger on page 97

**Shield:**

- Unshielded

**Jacket:**

- Premium PVC
- Operating temperature range: -30°C to +105°C (Type CM) -30°C to +80°C (AWM)

**Applications:**

- Advanced signal transmission in controlled environments
- Medical instrumentation and equipment
- Consumer electronic peripherals
- Industrial process control systems
- Suitable for EIA RS-232 applications

**Features:**

- Oil-resistant per UL Oil Res I and Class 43
- Sunlight-resistant
- Nylon ripcord

**Compliances:**

- NEC Article 800 Type CM (UL: 105°C)
- UL Style 2464 (UL: 80°C, 300 V, VW-1)
- CSA Type CMG (CSA: 105°C, FT4)
- RoHS Compliant Directive 2015/863/EU (RoHS-3)
- Vertical Tray Cable Flame Test per UL 1581 and IEEE 383 (70,000 BTU)

**Packaging:**

- Please contact Customer Service for packaging and color options
- Data subject to change.





# EXZEL® Multi-Paired, Foil Shielded

UL 2464, NEC Type CM (UL), CSA CMG

**Product Construction:**

**Conductor:**

- Fully annealed stranded tinned copper per ASTM B33

**Insulation:**

- Premium-grade, color-coded PVC
- Color per Chart C for 24 AWG and 22 AWG on page 97
- Color per Chart D for 20 AWG and larger on page 97

**Shield:**

- 100% Flexfoil® aluminum/polyester, foil facing in
- Stranded tinned copper drain wire

**Jacket:**

- Premium PVC
- Operating temperature range: -30°C to +105°C (Type CM)
- -30°C to +80°C (AWM)

**Applications:**

- Advanced signal transmission in controlled environments
- Medical instrumentation and equipment
- Consumer electronic peripherals
- Industrial process control systems
- Suitable for EIA RS-232 applications

**Features:**

- Oil-resistant per UL Oil Res I and Class 43
- Sunlight-resistant
- Nylon ripcord

**Compliances:**

- NEC Article 800 Type CM (UL: 105°C)
- UL Style 2464 (UL: 80°C, 300 V, VW-1)
- CSA Type CMG (CSA: 105°C, FT4)
- RoHS Compliant Directive 2015/863/EU (RoHS-3)
- Vertical Tray Cable Flame Test per UL 1581 and IEEE 383 (70,000 BTU)

**Packaging:**

- Please contact Customer Service for packaging and color options
- Data subject to change.

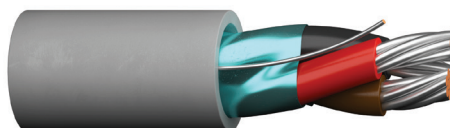

PART NUMBER	PAIRS	AWG SIZE	COND. STRAND	NOMINAL INSULATION THICKNESS		NOMINAL JACKET THICKNESS		NOMINAL CABLE DIAMETER	
				in	mm	in	mm	in	mm
C9400A	1	24	7/32	0.010	0.25	0.032	0.81	0.157	3.99
C9401A	2	24	7/32	0.010	0.25	0.032	0.81	0.215	5.47
C9402A	3	24	7/32	0.010	0.25	0.032	0.81	0.226	5.74
C9403A	4	24	7/32	0.010	0.25	0.032	0.81	0.246	6.24
C9404A	5	24	7/32	0.010	0.25	0.032	0.81	0.266	6.75
C9405A	6	24	7/32	0.010	0.25	0.032	0.81	0.287	7.30
C9406A	9	24	7/32	0.010	0.25	0.032	0.81	0.331	8.42
C9407A	11	24	7/32	0.010	0.25	0.032	0.81	0.359	9.13
C9408A	15	24	7/32	0.010	0.25	0.032	0.81	0.410	10.41
C9410A	1	22	7/30	0.010	0.25	0.032	0.81	0.169	4.29
C9411A	2	22	7/30	0.010	0.25	0.032	0.81	0.235	5.98
C9412A	3	22	7/30	0.010	0.25	0.032	0.81	0.248	6.29
C9413A	4	22	7/30	0.010	0.25	0.032	0.81	0.270	6.85
C9414A	5	22	7/30	0.010	0.25	0.032	0.81	0.293	7.44
C9415A	6	22	7/30	0.010	0.25	0.032	0.81	0.318	8.06
C9416A	9	22	7/30	0.010	0.25	0.032	0.81	0.368	9.34
C9417A	11	22	7/30	0.010	0.25	0.032	0.81	0.400	10.15
C9418A	15	22	7/30	0.010	0.25	0.032	0.81	0.457	11.61
C9420A	2	20	7/28	0.016	0.41	0.032	0.81	0.299	7.60
C9421A	3	20	7/28	0.016	0.41	0.032	0.81	0.316	8.03
C9422A	6	20	7/28	0.016	0.41	0.032	0.81	0.413	10.49
C9423A	9	20	7/28	0.016	0.41	0.032	0.81	0.483	12.26
C9424A	12	20	7/28	0.016	0.41	0.032	0.81	0.544	13.82
C9426A	3	18	16/30	0.016	0.41	0.032	0.81	0.352	8.95
C9427A	6	18	16/30	0.016	0.41	0.032	0.81	0.463	11.77



# EXZEL® Multi-Paired, Foil/Braid Shielded

UL 2464, NEC Type CM (UL), CSA CMG

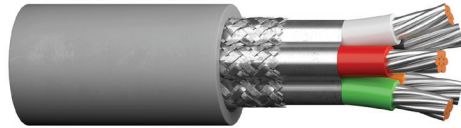

PART NUMBER	PAIRS	AWG SIZE	COND. STRAND	NOMINAL INSULATION THICKNESS		NOMINAL JACKET THICKNESS		NOMINAL CABLE DIAMETER	
				in	mm	in	mm	in	mm
C9500A	1	24	7/32	0.010	0.25	0.032	0.81	0.184	4.67
C9501A	2	24	7/32	0.010	0.25	0.032	0.81	0.242	6.10
C9502A	3	24	7/32	0.010	0.25	0.032	0.81	0.253	6.40
C9503A	4	24	7/32	0.010	0.25	0.032	0.81	0.273	6.88
C9504A	5	24	7/32	0.010	0.25	0.032	0.81	0.293	7.42
C9505A	6	24	7/32	0.010	0.25	0.032	0.81	0.314	7.98
C9506A	9	24	7/32	0.010	0.25	0.032	0.81	0.358	9.14
C9507A	11	24	7/32	0.010	0.25	0.032	0.81	0.386	9.78
C9508A	15	24	7/32	0.010	0.25	0.032	0.81	0.437	10.90
C9510A	1	22	7/30	0.010	0.25	0.032	0.81	0.196	4.98
C9511A	2	22	7/30	0.010	0.25	0.032	0.81	0.262	6.60
C9512A	3	22	7/30	0.010	0.25	0.032	0.81	0.275	6.93
C9513A	4	22	7/30	0.010	0.25	0.032	0.81	0.297	7.49
C9514A	5	22	7/30	0.010	0.25	0.032	0.81	0.320	8.10
C9515A	6	22	7/30	0.010	0.25	0.032	0.81	0.345	8.74
C9516A	9	22	7/30	0.010	0.25	0.032	0.81	0.395	10.06
C9517A	11	22	7/30	0.010	0.25	0.032	0.81	0.427	10.77
C9518A	15	22	7/30	0.010	0.25	0.032	0.81	0.484	12.07
C9520A	2	20	7/28	0.016	0.41	0.032	0.81	0.326	8.28
C9521A	3	20	7/28	0.016	0.41	0.032	0.81	0.343	8.74
C9522A	6	20	7/28	0.016	0.41	0.032	0.81	0.440	11.25
C9523A	9	20	7/28	0.016	0.41	0.032	0.81	0.510	13.08
C9525A	2	18	16/30	0.016	0.41	0.032	0.81	0.360	9.02
C9526A	3	18	16/30	0.016	0.41	0.032	0.81	0.379	9.55
C9527A	6	18	16/30	0.016	0.41	0.032	0.81	0.490	12.40
C9528A	9	18	16/30	0.016	0.41	0.053	1.35	0.612	15.52

**Product Construction:**

**Conductor:**

- Fully annealed stranded tinned copper per ASTM B33

**Insulation:**

- Premium-grade, color-coded PVC
- Color per Chart C for 24 AWG and 22 AWG on page 97
- Color per Chart D for 20 AWG and larger on page 97

**Shield:**

- Dual foil with overall braided shield
- Aluminum/polyester/aluminum foil with 100% coverage
- Stranded tinned copper drain wire
- Tinned copper braided shield, 70% min coverage

**Jacket:**

- Premium PVC
- Operating temperature range: -30°C to +105°C (Type CM) -30°C to +80°C (AWM)

**Applications:**

- Advanced signal transmission in controlled environments
- Medical instrumentation and equipment
- Consumer electronic peripherals
- Industrial process control systems
- Suitable for EIA RS-232 applications

**Features:**

- Oil-resistant per UL Oil Res I and Class 43
- Sunlight-resistant
- Nylon ripcord

**Compliances:**

- NEC Article 800 Type CM (UL: 105°C)
- UL Style 2464 (UL: 80°C, 300 V, VW-1)
- CSA Type CMG (CSA: 105°C, FT4)
- RoHS Compliant Directive 2015/863/EU (RoHS-3)
- Vertical Tray Cable Flame Test per UL 1581 and IEEE 383 (70,000 BTU)

**Packaging:**

- Please contact Customer Service for packaging and color options
- Data subject to change.



# EXZEL® Multi-Conductor, Unshielded, Heavy Duty

UL 2343, NEC Type CM (UL), CSA CMG

**Product Construction:**

**Conductor:**

- Fully annealed stranded tinned copper per ASTM B33

**Insulation:**

- Premium-grade, color-coded PVC
- Color per Chart A on page 97

**Shield:**

- Unshielded

**Jacket:**

- Premium PVC
- Operating temperature range:  
-30°C to +105°C (Type CM)  
-30°C to +80°C (AWM)

**Applications:**

- Advanced signal transmission in controlled environments
- Medical instrumentation and equipment
- Consumer electronic peripherals
- Industrial process control systems
- Suitable for EIA RS-232 applications

**Features:**

- Oil-resistant per UL Oil Res I and Class 43
- Sunlight-resistant
- Nylon ripcord

**Compliances:**

- NEC Article 800 Type CM (UL: 105°C)
- UL Style 2343 (UL: 80°C, VW-1)
- CSA Type CMG (CSA: 105°C, FT4)
- RoHS Compliant Directive 2015/863/EU (RoHS-3)
- Vertical Tray Cable Flame Test per UL 1581 and IEEE 383 (70,000 BTU)

**Packaging:**

- Please contact Customer Service for packaging and color options
- Data subject to change.

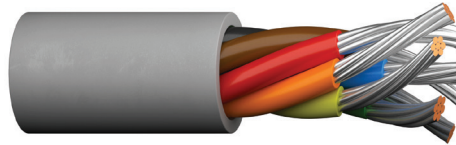

PART NUMBER	COND.	AWG SIZE	COND. STRAND	NOMINAL INSULATION THICKNESS		NOMINAL JACKET THICKNESS		NOMINAL CABLE DIAMETER	
				in	mm	in	mm	in	mm
C9058A	7	24	7/32	0.010	0.25	0.063	1.6	0.260	6.60
C9059A	12	24	7/32	0.010	0.25	0.063	1.6	0.309	7.86
C9060A	15	24	7/32	0.010	0.25	0.063	1.6	0.333	8.46
C9061A	19	24	7/32	0.010	0.25	0.063	1.6	0.346	8.79
C9062A	2	22	7/30	0.010	0.25	0.063	1.6	0.229	5.82
C9063A	7	22	7/30	0.010	0.25	0.063	1.6	0.278	7.06
C9064A	12	22	7/30	0.010	0.25	0.063	1.6	0.334	8.49
C9065A	15	22	7/30	0.010	0.25	0.063	1.6	0.361	9.18
C9066A	19	22	7/30	0.010	0.25	0.063	1.6	0.376	9.55
C9067A	25	22	7/30	0.010	0.25	0.063	1.6	0.425	10.80
C9068A	2	20	7/28	0.010	0.25	0.063	1.6	0.243	6.17
C9069A	5	20	7/28	0.010	0.25	0.063	1.6	0.282	7.17
C9070A	7	20	7/28	0.010	0.25	0.063	1.6	0.299	7.59
C9071A	12	20	7/28	0.010	0.25	0.063	1.6	0.363	9.23
C9072A	15	20	7/28	0.010	0.25	0.063	1.6	0.394	10.01
C9073A	19	20	7/28	0.010	0.25	0.063	1.6	0.411	10.44
C9074A	25	20	7/28	0.010	0.25	0.063	1.6	0.467	11.86

# EXZEL® Multi-Conductor, Foil Shielded, Heavy Duty

UL 2343, NEC Type CM (UL), CSA CMG

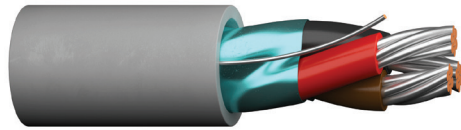

PART NUMBER	COND.	AWG SIZE	COND. STRAND	NOMINAL INSULATION THICKNESS		NOMINAL JACKET THICKNESS		NOMINAL CABLE DIAMETER	
				in	mm	in	mm	in	mm
C9158A	3	24	7/32	0.010	0.25	0.063	1.6	0.225	5.73
C9159A	5	24	7/32	0.010	0.25	0.063	1.6	0.249	6.33
C9160A	7	24	7/32	0.010	0.25	0.063	1.6	0.262	6.65
C9161A	12	24	7/32	0.010	0.25	0.063	1.6	0.311	7.91
C9162A	15	24	7/32	0.010	0.25	0.063	1.6	0.335	8.51
C9163A	19	24	7/32	0.010	0.25	0.063	1.6	0.348	8.84
C9164A	2	22	7/30	0.010	0.25	0.063	1.6	0.231	5.87
C9165A	5	22	7/30	0.010	0.25	0.063	1.6	0.265	6.74
C9166A	7	22	7/30	0.010	0.25	0.063	1.6	0.280	7.11
C9167A	12	22	7/30	0.010	0.25	0.063	1.6	0.336	8.54
C9168A	15	22	7/30	0.010	0.25	0.063	1.6	0.363	9.23
C9169A	19	22	7/30	0.010	0.25	0.063	1.6	0.378	9.60
C9170A	2	20	7/28	0.010	0.25	0.063	1.6	0.245	6.22
C9171A	5	20	7/28	0.010	0.25	0.063	1.6	0.284	7.22
C9172A	7	20	7/28	0.010	0.25	0.063	1.6	0.301	7.65
C9173A	12	20	7/28	0.010	0.25	0.063	1.6	0.365	9.28
C9174A	15	20	7/28	0.010	0.25	0.063	1.6	0.396	10.06
C9175A	19	20	7/28	0.010	0.25	0.063	1.6	0.413	10.49

**Product Construction:**

**Conductor:**

- Fully annealed stranded tinned copper per ASTM B33

**Insulation:**

- Premium-grade, color-coded PVC
- Color per Chart A on page 97

**Shield:**

- 100% Flexfoil® aluminum/polyester, foil facing in
- Stranded tinned copper drain wire

**Jacket:**

- Premium PVC
- Operating temperature range: -30°C to +105°C (Type CM)
- -30°C to +80°C (AWM)

**Applications:**

- Advanced signal transmission in controlled environments
- Medical instrumentation and equipment
- Consumer electronic peripherals
- Industrial process control systems
- Suitable for EIA RS-232 applications

**Features:**

- Oil-resistant per UL Oil Res I and Class 43
- Sunlight-resistant
- Nylon ripcord

**Compliances:**

- NEC Article 800 Type CM (UL: 105°C)
- UL Style 2343 (UL: 80°C, VW-1)
- CSA Type CMG (CSA: 105°C, FT4)
- RoHS Compliant Directive 2015/863/EU (RoHS-3)
- Vertical Tray Cable Flame Test per UL 1581 and IEEE 383 (70,000 BTU)

**Packaging:**

- Please contact Customer Service for packaging and color options
- Data subject to change.



# EXZEL® Multi-Conductor, Foil/Braid Shielded, Heavy Duty

UL 2343, NEC Type CM (UL), CSA CMG

**Product Construction:**

**Conductor:**

- Fully annealed stranded tinned copper per ASTM B33

**Insulation:**

- Premium-grade, color-coded PVC
- Color per Chart A on page 97

**Shield:**

- Dual foil with overall braided shield
- Aluminum/polyester/aluminum foil with 100% coverage
- Stranded tinned copper drain wire
- Tinned copper braided shield, 70% min coverage

**Jacket:**

- Premium PVC
- Operating temperature range: -30°C to +105°C (Type CM) -30°C to +80°C (AWM)

**Applications:**

- Advanced signal transmission in controlled environments
- Medical instrumentation and equipment
- Consumer electronic peripherals
- Industrial process control systems
- Suitable for EIA RS-232 applications

**Features:**

- Oil-resistant per UL Oil Res I and Class 43
- Sunlight-resistant
- Nylon ripcord

**Compliances:**

- NEC Article 800 Type CM (UL: 105°C)
- UL Style 2343 (UL: 80°C, VW-1)
- CSA Type CMG (CSA: 105°C, FT4)
- RoHS Compliant Directive 2015/863/EU (RoHS-3)
- Vertical Tray Cable Flame Test per UL 1581 and IEEE 383 (70,000 BTU)

**Packaging:**

- Please contact Customer Service for packaging and color options
- Data subject to change.

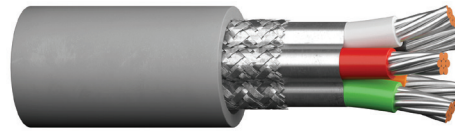

PART NUMBER	COND.	AWG SIZE	COND. STRAND	NOMINAL INSULATION THICKNESS		NOMINAL JACKET THICKNESS		NOMINAL CABLE DIAMETER	
				in	mm	in	mm	in	mm
C9258A	5	24	7/32	0.010	0.25	0.063	1.6	0.276	7.01
C9259A	7	24	7/32	0.010	0.25	0.063	1.6	0.289	7.34
C9260A	12	24	7/32	0.010	0.25	0.063	1.6	0.338	8.60
C9261A	15	24	7/32	0.010	0.25	0.063	1.6	0.362	9.20
C9262A	19	24	7/32	0.010	0.25	0.063	1.6	0.375	9.53
C9263A	5	22	7/30	0.010	0.25	0.063	1.6	0.292	7.42
C9264A	7	22	7/30	0.010	0.25	0.063	1.6	0.307	7.80
C9265A	12	22	7/30	0.010	0.25	0.063	1.6	0.363	9.23
C9266A	15	22	7/30	0.010	0.25	0.063	1.6	0.390	9.91
C9267A	19	22	7/30	0.010	0.25	0.063	1.6	0.405	10.29
C9268A	4	20	7/28	0.010	0.25	0.063	1.6	0.296	7.51
C9269A	5	20	7/28	0.010	0.25	0.063	1.6	0.311	7.90
C9270A	7	20	7/28	0.010	0.25	0.063	1.6	0.328	8.33
C9271A	12	20	7/28	0.010	0.25	0.063	1.6	0.392	9.97
C9272A	15	20	7/28	0.010	0.25	0.063	1.6	0.423	10.75
C9273A	19	20	7/28	0.010	0.25	0.063	1.6	0.440	11.18

# EXZEL® Multi-Paired, Foil/Braid Shielded, Heavy Duty

UL 2343, NEC Type CM (UL), CSA CMG

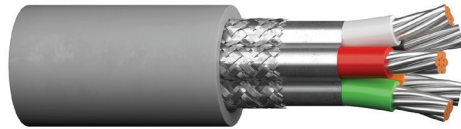

PART NUMBER	PAIRS	AWG SIZE	COND. STRAND	NOMINAL INSULATION THICKNESS		NOMINAL JACKET THICKNESS		NOMINAL CABLE DIAMETER	
				in	mm	in	mm	in	mm
C9538A	5	24	7/32	0.010	0.25	0.063	1.6	0.355	9.01
C9539A	7	24	7/32	0.010	0.25	0.063	1.6	0.376	9.56
C9540A	12	24	7/32	0.010	0.25	0.063	1.6	0.459	11.67
C9541A	15	24	7/32	0.010	0.25	0.063	1.6	0.499	12.67
C9543A	2	22	7/30	0.010	0.25	0.063	1.6	0.324	8.24
C9544A	5	22	7/30	0.010	0.25	0.063	1.6	0.382	9.70
C9545A	7	22	7/30	0.010	0.25	0.063	1.6	0.407	10.33
C9546A	12	22	7/30	0.010	0.25	0.063	1.6	0.501	12.73
C9548A	4	20	7/28	0.010	0.25	0.063	1.6	0.387	9.84
C9549A	5	20	7/28	0.010	0.25	0.063	1.6	0.414	10.50
C9550A	7	20	7/28	0.010	0.25	0.063	1.6	0.442	11.22
C9551A	9	20	7/28	0.010	0.25	0.063	1.6	0.499	12.68
C9552A	15	20	7/28	0.010	0.25	0.063	1.6	0.601	15.28

**Product Construction:**

**Conductor:**

- Fully annealed stranded tinned copper per ASTM B33

**Insulation:**

- Premium-grade, color-coded PVC
- Color per Chart C on page 97

**Shield:**

- Dual foil with overall braided shield
- Aluminum/polyester/aluminum foil with 100% coverage
- Stranded tinned copper drain wire
- Tinned copper braided shield, 70% min coverage

**Jacket:**

- Premium PVC
- Operating temperature range: -30°C to +105°C

**Applications:**

- Advanced signal transmission in controlled environments
- Medical instrumentation and equipment
- Consumer electronic peripherals
- Industrial process control systems
- Suitable for EIA RS-232 applications

**Features:**

- Oil-resistant per UL Oil Res I and Class 43
- Sunlight-resistant
- Nylon ripcord

**Compliances:**

- NEC Article 800 Type CM (UL: 105°C)
- UL Style 2343 (UL: 80°C, VW-1)
- CSA Type CMG (CSA: 105°C, FT4)
- RoHS Compliant Directive 2015/863/EU (RoHS-3)
- Vertical Tray Cable Flame Test per UL 1581 and IEEE 383 (70,000 BTU)

**Packaging:**

- Please contact Customer Service for packaging and color options
- Data subject to change.

# EXZEL® LSZH Multi-Conductor, Unshielded

NEC Type CM, CMG, CL2 or PLTC-ER (UL)

**Product Construction:**

**Conductor:**

- Fully annealed stranded tinned copper per ASTM B33

**Insulation:**

- Premium-grade, color-coded LSZH
- Color per Chart A for 24 AWG and 22 AWG on page 97
- Color per Chart B for 20 AWG and larger on page 97
- International colors per IEC Color Chart on page 97

**Shield:**

- Unshielded

**Jacket:**

- Premium FR-LSZH (Thermoplastic Polyolefin)
- Operating temperature range: -40°C to +105°C

**Applications:**

- Advanced signal transmission in controlled environments
- Medical instrumentation and equipment
- Consumer electronic peripherals
- Industrial process control systems
- Suitable for EIA RS-232 applications

**Features:**

- Oil-resistant (OIL RES I)
- Sunlight-resistant (SUN RES)
- Nylon ripcord
- UV-resistant

**Compliances:**

- NEC Article 725 Type PLTC-ER (22 AWG and larger, UL: 105°C, 300 V)
- (-ER): approved for Exposed Run as defined per NEC Article 725
- NEC Article 725 Type CL2 (UL: 105°C, 150 V)
- NEC Article 800 Type CM/CMG (UL: 105°C, 300 V)
- RoHS Compliant Directive 2015/863/EU (RoHS-3)

**Compliances: Flame & Smoke**

- Vertical Tray Cable Flame Test per UL 1581 and IEEE 383 (70,000 BTU)
- CSA FT4/IEEE 1202 flame test per UL 1685
- IEC 60332-1, 3, Cat A: Flammability
- IEC 61034-1, 2 and Mil-DTL-24643B and NES 711: Smoke Index Emission
- IEC 60754-1, 2 and Mil-DTL-24643B: Halogen Content and Acid Gas Generation

**Packaging:**

- Please contact Customer Service for packaging and color options
- Data subject to change.

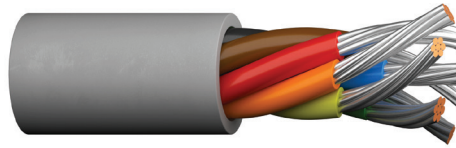

PART NUMBER	COND.	AWG SIZE	COND. STRAND	NOMINAL INSULATION THICKNESS		NOMINAL JACKET THICKNESS		NOMINAL CABLE DIAMETER	
				in	mm	in	mm	in	mm
C9000ZH	2	24	7/32	0.010	0.25	0.032	0.81	0.160	4.06
C9001ZH	3	24	7/32	0.010	0.25	0.032	0.81	0.167	4.23
C9002ZH	4	24	7/32	0.010	0.25	0.032	0.81	0.178	4.53
C9003ZH	6	24	7/32	0.010	0.25	0.032	0.81	0.204	5.18
C9004ZH	8	24	7/32	0.010	0.25	0.032	0.81	0.218	5.53
C9005ZH	10	24	7/32	0.010	0.25	0.032	0.81	0.248	6.30
C9006ZH	15	24	7/32	0.010	0.25	0.037	0.94	0.289	7.34
C9007ZH	20	24	7/32	0.010	0.25	0.037	0.94	0.316	8.02
C9008ZH	25	24	7/32	0.010	0.25	0.037	0.94	0.346	8.79
C9009ZH	2	22	7/30	0.013	0.33	0.037	0.94	0.182	4.62
C9010ZH	3	22	7/30	0.013	0.33	0.037	0.94	0.190	4.81
C9011ZH	4	22	7/30	0.013	0.33	0.037	0.94	0.203	5.16
C9012ZH	6	22	7/30	0.013	0.33	0.037	0.94	0.232	5.89
C9013ZH	8	22	7/30	0.013	0.33	0.037	0.94	0.248	6.29
C9014ZH	10	22	7/30	0.013	0.33	0.042	1.07	0.292	7.42
C9015ZH	15	22	7/30	0.013	0.33	0.042	1.07	0.327	8.31
C9016ZH	20	22	7/30	0.013	0.33	0.042	1.07	0.358	9.08
C9017ZH	25	22	7/30	0.013	0.33	0.052	1.32	0.412	10.46
C9018ZH	2	20	7/28	0.016	0.41	0.037	0.94	0.222	5.64
C9019ZH	3	20	7/28	0.016	0.41	0.037	0.94	0.233	5.91
C9020ZH	4	20	7/28	0.016	0.41	0.037	0.94	0.251	6.39
C9021ZH	6	20	7/28	0.016	0.41	0.042	1.07	0.302	7.67
C9022ZH	8	20	7/28	0.016	0.41	0.042	1.07	0.324	8.22
C9023ZH	10	20	7/28	0.016	0.41	0.042	1.07	0.372	9.45
C9024ZH	15	20	7/28	0.016	0.41	0.052	1.32	0.441	11.20
C9025ZH	20	20	7/28	0.016	0.41	0.052	1.32	0.484	12.29
C9026ZH	25	20	7/28	0.016	0.41	0.052	1.32	0.532	13.51
C9027ZH*	2	18	16/30	0.016	0.41	0.037	0.94	0.238	6.05
C9028ZH*	2	18	16/30	0.016	0.41	0.037	0.94	0.238	6.05
C9029ZH*	3	18	16/30	0.016	0.41	0.037	0.94	0.250	6.34
C9030ZH	3	18	16/30	0.016	0.41	0.037	0.94	0.250	6.34
C9031ZH	4	18	16/30	0.016	0.41	0.037	0.94	0.271	6.88
C9032ZH	6	18	16/30	0.016	0.41	0.042	1.07	0.326	8.28
C9033ZH	8	18	16/30	0.016	0.41	0.042	1.07	0.350	8.89
C9034ZH	10	18	16/30	0.016	0.41	0.052	1.32	0.424	10.77
C9035ZH	15	18	16/30	0.016	0.41	0.052	1.32	0.479	12.16
C9036ZH	20	18	16/30	0.016	0.41	0.052	1.32	0.526	13.36
C9037ZH	25	18	16/30	0.016	0.41	0.052	1.32	0.580	14.73
C9038ZH*	2	16	19/0117	0.016	0.41	0.037	0.94	0.262	6.65
C9039ZH*	2	16	19/0117	0.016	0.41	0.037	0.94	0.262	6.65
C9040ZH*	3	16	19/0117	0.016	0.41	0.037	0.94	0.276	7.00
C9041ZH	3	16	19/0117	0.016	0.41	0.037	0.94	0.276	7.00
C9042ZH	4	16	19/0117	0.016	0.41	0.042	1.07	0.310	7.87
C9043ZH	6	16	19/0117	0.016	0.41	0.042	1.07	0.362	9.19
C9044ZH	8	16	19/0117	0.016	0.41	0.052	1.32	0.410	10.41
C9045ZH	10	16	19/0117	0.016	0.41	0.052	1.32	0.472	11.99
C9046ZH	15	16	19/0117	0.016	0.41	0.052	1.32	0.535	13.59
C9047ZH	20	16	19/0117	0.016	0.41	0.052	1.32	0.590	14.98
C9048ZH	25	16	19/0117	0.016	0.41	0.062	1.57	0.672	17.07

\* IEC Color Code: Brown, Blue, Green/Yellow.

# EXZEL® LSZH Multi-Conductor, Foil Shielded

NEC Type CM, CMG, CL2 or PLTC-ER (UL)

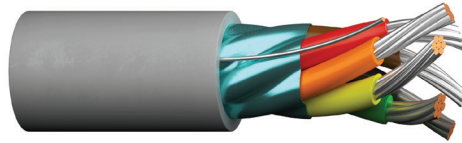

PART NUMBER	COND.	AWG SIZE	COND. STRAND	NOMINAL INSULATION THICKNESS		NOMINAL JACKET THICKNESS		NOMINAL CABLE DIAMETER	
				in	mm	in	mm	in	mm
C9100ZH	2	24	7/32	0.010	0.25	0.032	0.81	0.165	4.19
C9101ZH	3	24	7/32	0.010	0.25	0.032	0.81	0.172	4.36
C9102ZH	4	24	7/32	0.010	0.25	0.032	0.81	0.183	4.66
C9103ZH	6	24	7/32	0.010	0.25	0.032	0.81	0.209	5.31
C9104ZH	8	24	7/32	0.010	0.25	0.032	0.81	0.223	5.66
C9105ZH	10	24	7/32	0.010	0.25	0.032	0.81	0.253	6.43
C9106ZH	15	24	7/32	0.010	0.25	0.037	0.94	0.294	7.46
C9107ZH	20	24	7/32	0.010	0.25	0.037	0.94	0.321	8.14
C9108ZH	25	24	7/32	0.010	0.25	0.037	0.94	0.351	8.92
C9109ZH	2	22	7/30	0.013	0.33	0.037	0.94	0.187	4.75
C9110ZH	3	22	7/30	0.013	0.33	0.037	0.94	0.195	4.94
C9111ZH	4	22	7/30	0.013	0.33	0.037	0.94	0.208	5.28
C9112ZH	6	22	7/30	0.013	0.33	0.037	0.94	0.237	6.02
C9113ZH	8	22	7/30	0.013	0.33	0.037	0.94	0.253	6.41
C9114ZH	10	22	7/30	0.013	0.33	0.042	1.07	0.297	7.54
C9115ZH	15	22	7/30	0.013	0.33	0.042	1.07	0.332	8.43
C9116ZH	20	22	7/30	0.013	0.33	0.042	1.07	0.363	9.21
C9117ZH	25	22	7/30	0.013	0.33	0.052	1.32	0.417	10.59
C9118ZH	2	20	7/28	0.016	0.41	0.037	0.94	0.227	5.77
C9119ZH	3	20	7/28	0.016	0.41	0.037	0.94	0.238	6.03
C9120ZH	4	20	7/28	0.016	0.41	0.037	0.94	0.256	6.51
C9121ZH	6	20	7/28	0.016	0.41	0.042	1.07	0.307	7.80
C9122ZH	8	20	7/28	0.016	0.41	0.042	1.07	0.329	8.35
C9123ZH	10	20	7/28	0.016	0.41	0.042	1.07	0.377	9.58
C9124ZH	15	20	7/28	0.016	0.41	0.052	1.32	0.446	11.33
C9125ZH	20	20	7/28	0.016	0.41	0.052	1.32	0.489	12.41
C9126ZH	25	20	7/28	0.016	0.41	0.052	1.32	0.537	13.64
C9127ZH	2	18	16/30	0.016	0.41	0.037	0.94	0.243	6.17
C9128ZH*	2	18	16/30	0.016	0.41	0.037	0.94	0.243	6.17
C9129ZH	3	18	16/30	0.016	0.41	0.037	0.94	0.255	6.47
C9130ZH*	3	18	16/30	0.016	0.41	0.037	0.94	0.255	6.47
C9131ZH	4	18	16/30	0.016	0.41	0.037	0.94	0.276	7.00
C9132ZH	6	18	16/30	0.016	0.41	0.042	1.07	0.331	8.41
C9133ZH	8	18	16/30	0.016	0.41	0.042	1.07	0.355	9.02
C9134ZH	10	18	16/30	0.016	0.41	0.052	1.32	0.429	10.90
C9135ZH	15	18	16/30	0.016	0.41	0.052	1.32	0.484	12.28
C9136ZH	20	18	16/30	0.016	0.41	0.052	1.32	0.531	13.49
C9137ZH	25	18	16/30	0.016	0.41	0.052	1.32	0.585	14.86
C9138ZH	2	16	19/0117	0.016	0.41	0.037	0.94	0.267	6.78
C9139ZH*	2	16	19/0117	0.016	0.41	0.037	0.94	0.267	6.78
C9140ZH	3	16	19/0117	0.016	0.41	0.037	0.94	0.281	7.12
C9141ZH*	3	16	19/0117	0.016	0.41	0.037	0.94	0.281	7.12
C9142ZH	4	16	19/0117	0.016	0.41	0.042	1.07	0.315	8.00
C9143ZH	6	16	19/0117	0.016	0.41	0.042	1.07	0.367	9.32
C9144ZH	8	16	19/0117	0.016	0.41	0.052	1.32	0.415	10.54
C9145ZH	10	16	19/0117	0.016	0.41	0.052	1.32	0.477	12.12
C9146ZH	15	16	19/0117	0.016	0.41	0.052	1.32	0.540	13.72
C9147ZH	20	16	19/0117	0.016	0.41	0.052	1.32	0.595	15.11
C9148ZH	25	16	19/0117	0.016	0.41	0.062	1.57	0.677	17.20

\* IEC Color Code: Brown, Blue, Green/Yellow.

**Product Construction:**

**Conductor:**

- Fully annealed stranded tinned copper per ASTM B33

**Insulation:**

- Premium-grade, color-coded LSZH (Thermoplastic Polyolefin)
- Color per Chart A for 24 AWG and 22 AWG on page 97
- Color per Chart B for 20 AWG and larger on page 97
- International colors per IEC Color Chart on page 97

**Shield:**

- 100% Flexfoil®, aluminum/polyester/aluminum, foil facing in
- Stranded tinned copper drain wire

**Jacket:**

- Premium FR-LSZH (Thermoplastic Polyolefin)
- Operating temperature range: -40°C to +105°C

**Applications:**

- Advanced signal transmission in controlled environments
- Medical instrumentation and equipment
- Consumer electronic peripherals
- Industrial process control systems
- Suitable for EIA RS-232 applications

**Features:**

- Oil-resistant (OIL RES I)
- Sunlight-resistant (SUN RES)
- Nylon ripcord
- UV-resistant

**Compliances:**

- NEC Article 725 Type PLTC-ER (22 AWG and larger, UL: 105°C, 300 V)
- (-ER): approved for Exposed Run as defined per NEC Article 725
- NEC Article 725 Type CL2 (UL: 105°C, 150 V)
- NEC Article 800 Type CM/CMG (UL: 105°C, 300 V)
- RoHS Compliant Directive 2015/863/EU (RoHS-3)

**Compliances: Flame & Smoke**

- Vertical Tray Cable Flame Test per UL 1581 and IEEE 383 (70,000 BTU)
- CSA FT4/IEEE 1202 flame test per UL 1685
- IEC 60332-1, 3, Cat A: Flammability
- IEC 61034-1, 2 and Mil-DTL-24643B and NES 711: Smoke Index Emission
- IEC 60754-1, 2 and Mil-DTL-24643B: Halogen Content and Acid Gas Generation

**Packaging**

- Please contact Customer Service for packaging and color options
- Data subject to change.





# EXZEL® LSZH Multi-Conductor, Foil/Braid Shielded

NEC Type CM, CMG, CL2 or PLTC-ER (UL)

**Product Construction:**

**Conductor:**

- Full annealed stranded tinned copper per ASTM B33

**Insulation:**

- Premium-grade, color-coded LSZH (Thermoplastic Polyolefin)
- Color per Chart A for 24 AWG and 22 AWG on page 97
- Color per Chart B for 20 AWG and larger on page 97
- International colors per IEC Color Chart on page 97

**Shield:**

- Dual foil with overall braided shield
- Aluminum/polyester/aluminum foil with 100% coverage
- Stranded tinned copper drain wire
- Tinned copper braided shield, 85% min. coverage

**Jacket:**

- Premium FR-LSZH (Thermoplastic Polyolefin)
- Operating temperature range: -40°C to +105°C

**Applications:**

- Advanced signal transmission in controlled environments
- Medical instrumentation and equipment
- Consumer electronic peripherals
- Industrial process control systems
- Suitable for EIA RS-232 applications

**Features:**

- Oil-resistant (OIL RES I)
- Sunlight-resistant (SUN RES)
- Nylon ripcord
- UV-resistant

**Compliances:**

- NEC Article 725 Type PLTC-ER (22 AWG and larger, UL: 105°C, 300 V)
- (-ER): approved for Exposed Run as defined per NEC Article 725
- NEC Article 725 Type CL2 (UL: 105°C, 150 V)
- NEC Article 800 Type CM/CMG (UL: 105°C, 300 V)
- RoHS Compliant Directive 2015/863/EU (RoHS-3)

**Compliances: Flame & Smoke**

- Vertical Tray Cable Flame Test per UL 1581 and IEEE 383 (70,000 BTU)
- CSA FT4/IEEE 1202 flame test per UL 1685
- IEC 60332-1, 3, Cat A: Flammability
- IEC 61034-1, 2 and Mil-DTL-24643B and NES 711: Smoke Index Emission
- IEC 60754-1, 2 and Mil-DTL-24643B: Halogen Content and Acid Gas Generation

**Packaging:**

- Please contact Customer Service for packaging and color options
- Data subject to change.

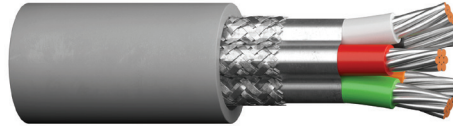

PART NUMBER	COND.	AWG SIZE	COND. STRAND	NOMINAL INSULATION THICKNESS		NOMINAL JACKET THICKNESS		NOMINAL CABLE DIAMETER	
				in	mm	in	mm	in	mm
C9200ZH	2	24	7/32	0.010	0.25	0.032	0.81	0.187	4.75
C9201ZH	3	24	7/32	0.010	0.25	0.032	0.81	0.194	4.92
C9202ZH	4	24	7/32	0.010	0.25	0.032	0.81	0.205	5.22
C9203ZH	6	24	7/32	0.010	0.25	0.032	0.81	0.231	5.87
C9204ZH	8	24	7/32	0.010	0.25	0.032	0.81	0.245	6.21
C9205ZH	10	24	7/32	0.010	0.25	0.037	0.94	0.285	7.24
C9206ZH	15	24	7/32	0.010	0.25	0.037	0.94	0.316	8.02
C9207ZH	20	24	7/32	0.010	0.25	0.037	0.94	0.343	8.70
C9208ZH	25	24	7/32	0.010	0.25	0.037	0.94	0.373	9.47
C9209ZH	2	22	7/30	0.013	0.33	0.037	0.94	0.209	5.31
C9210ZH	3	22	7/30	0.013	0.33	0.037	0.94	0.217	5.50
C9211ZH	4	22	7/30	0.013	0.33	0.037	0.94	0.230	5.84
C9212ZH	6	22	7/30	0.013	0.33	0.037	0.94	0.259	6.58
C9213ZH	8	22	7/30	0.013	0.33	0.037	0.94	0.275	6.97
C9214ZH	10	22	7/30	0.013	0.33	0.042	1.07	0.319	8.10
C9215ZH	15	22	7/30	0.013	0.33	0.042	1.07	0.354	8.99
C9216ZH	20	22	7/30	0.013	0.33	0.042	1.07	0.385	9.77
C9217ZH	25	22	7/30	0.013	0.33	0.052	1.32	0.444	11.28
C9218ZH	2	20	7/28	0.016	0.41	0.037	0.94	0.249	6.32
C9219ZH	3	20	7/28	0.016	0.41	0.037	0.94	0.260	6.59
C9220ZH	4	20	7/28	0.016	0.41	0.037	0.94	0.278	7.07
C9221ZH	6	20	7/28	0.016	0.41	0.042	1.07	0.329	8.36
C9222ZH	8	20	7/28	0.016	0.41	0.042	1.07	0.351	8.91
C9223ZH	10	20	7/28	0.016	0.41	0.052	1.32	0.419	10.64
C9224ZH	15	20	7/28	0.016	0.41	0.052	1.32	0.473	12.01
C9225ZH	20	20	7/28	0.016	0.41	0.052	1.32	0.516	13.10
C9226ZH	25	20	7/28	0.016	0.41	0.052	1.32	0.564	14.33
C9227ZH*	2	18	16/30	0.016	0.41	0.037	0.94	0.265	6.73
C9228ZH	2	18	16/30	0.016	0.41	0.037	0.94	0.265	6.73
C9229ZH*	3	18	16/30	0.016	0.41	0.037	0.94	0.277	7.03
C9230ZH	3	18	16/30	0.016	0.41	0.037	0.94	0.277	7.03
C9231ZH	4	18	16/30	0.016	0.41	0.042	1.07	0.308	7.82
C9232ZH	6	18	16/30	0.016	0.41	0.042	1.07	0.353	8.97
C9233ZH	8	18	16/30	0.016	0.41	0.042	1.07	0.377	9.58
C9234ZH	10	18	16/30	0.016	0.41	0.052	1.32	0.456	11.58
C9235ZH	15	18	16/30	0.016	0.41	0.052	1.32	0.511	12.97
C9236ZH	20	18	16/30	0.016	0.41	0.052	1.32	0.558	14.18
C9237ZH	25	18	16/30	0.016	0.41	0.062	1.57	0.632	16.05
C9238ZH*	2	16	19/0117	0.016	0.41	0.042	1.07	0.299	7.59
C9239ZH	2	16	19/0117	0.016	0.41	0.042	1.07	0.299	7.59
C9240ZH*	3	16	19/0117	0.016	0.41	0.042	1.07	0.313	7.94
C9241ZH	3	16	19/0117	0.016	0.41	0.042	1.07	0.313	7.94
C9242ZH	4	16	19/0117	0.016	0.41	0.042	1.07	0.337	8.55
C9243ZH	6	16	19/0117	0.016	0.41	0.052	1.32	0.409	10.39
C9244ZH	8	16	19/0117	0.016	0.41	0.052	1.32	0.437	11.10
C9245ZH	10	16	19/0117	0.016	0.41	0.052	1.32	0.504	12.80
C9246ZH	15	16	19/0117	0.016	0.41	0.052	1.32	0.567	14.40
C9247ZH	20	16	19/0117	0.016	0.41	0.062	1.57	0.642	16.30
C9248ZH	25	16	19/0117	0.016	0.41	0.062	1.57	0.704	17.88

\* IEC Color Code: Brown, Blue, Green/Yellow



# EXZEL® LSZH Multi-Paired, Unshielded

NEC Type CM, CMG, CL2 or PLTC-ER (UL)

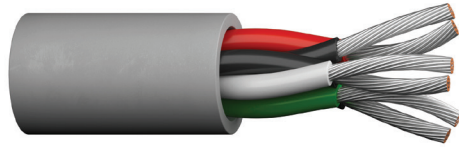

PART NUMBER	PAIRS	AWG SIZE	COND. STRAND	NOMINAL INSULATION THICKNESS		NOMINAL JACKET THICKNESS		NOMINAL CABLE DIAMETER	
				in	mm	in	mm	in	mm
C9300ZH	1	24	7/32	0.010	0.25	0.032	0.81	0.160	4.06
C9301ZH	2	24	7/32	0.010	0.25	0.032	0.81	0.220	5.58
C9302ZH	3	24	7/32	0.010	0.25	0.032	0.81	0.231	5.87
C9303ZH	4	24	7/32	0.010	0.25	0.032	0.81	0.251	6.37
C9304ZH	5	24	7/32	0.010	0.25	0.037	0.94	0.282	7.15
C9305ZH	6	24	7/32	0.010	0.25	0.037	0.94	0.304	7.72
C9306ZH	9	24	7/32	0.010	0.25	0.037	0.94	0.350	8.88
C9307ZH	11	24	7/32	0.010	0.25	0.037	0.94	0.378	9.59
C9308ZH	15	24	7/32	0.010	0.25	0.047	1.19	0.449	11.42
C9309ZH	1	22	7/30	0.013	0.33	0.037	0.94	0.182	4.62
C9310ZH	2	22	7/30	0.013	0.33	0.037	0.94	0.250	6.35
C9311ZH	3	22	7/30	0.013	0.33	0.037	0.94	0.263	6.67
C9312ZH	4	22	7/30	0.013	0.33	0.042	1.07	0.295	7.50
C9313ZH	5	22	7/30	0.013	0.33	0.042	1.07	0.319	8.10
C9314ZH	6	22	7/30	0.013	0.33	0.042	1.07	0.344	8.74
C9326ZH	9	22	7/30	0.013	0.33	0.052	1.32	0.416	10.57
C9327ZH	12	22	7/30	0.013	0.33	0.052	1.32	0.461	11.70
C9315ZH	15	22	7/30	0.013	0.33	0.052	1.32	0.507	12.87
C9328ZH	1	20	7/28	0.016	0.41	0.037	0.94	0.222	5.64
C9316ZH	2	20	7/28	0.016	0.41	0.042	1.07	0.327	8.31
C9317ZH	3	20	7/28	0.016	0.41	0.042	1.07	0.345	8.76
C9329ZH	4	20	7/28	0.016	0.41	0.042	1.07	0.377	9.57
C9330ZH	5	20	7/28	0.016	0.41	0.052	1.32	0.430	10.91
C9318ZH	6	20	7/28	0.016	0.41	0.052	1.32	0.465	11.81
C9319ZH	9	20	7/28	0.016	0.41	0.052	1.32	0.538	13.66
C9320ZH	12	20	7/28	0.016	0.41	0.052	1.32	0.600	15.24
C9331ZH	15	20	7/28	0.016	0.41	0.062	1.57	0.685	17.39
C9332ZH	1	18	16/30	0.016	0.41	0.037	0.94	0.238	6.05
C9321ZH	2	18	16/30	0.016	0.41	0.042	1.07	0.354	8.99
C9322ZH	3	18	16/30	0.016	0.41	0.042	1.07	0.374	9.49
C9333ZH	4	18	16/30	0.016	0.41	0.052	1.32	0.429	10.90
C9334ZH	5	18	16/30	0.016	0.41	0.052	1.32	0.466	11.83
C9323ZH	6	18	16/30	0.016	0.41	0.052	1.32	0.505	12.83
C9324ZH	9	18	16/30	0.016	0.41	0.052	1.32	0.586	14.89
C9325ZH	12	18	16/30	0.016	0.41	0.062	1.57	0.656	16.67
C9335ZH	15	18	16/30	0.016	0.41	0.062	1.57	0.748	19.00

**Product Construction:**

**Conductor:**

- Fully annealed stranded tinned copper per ASTM B33

**Insulation:**

- Premium-grade, color-coded LSZH (Thermoplastic Polyolefin)
- Color per Chart C for 24 AWG and 22 AWG on page 97
- Color per Chart D for 20 AWG and larger on page 97

**Shield:**

- Unshielded

**Jacket:**

- Premium FR-LSZH (Thermoplastic Polyolefin)
- Operating temperature range: -40°C to +105°C

**Applications:**

- Advanced signal transmission in controlled environments
- Medical instrumentation and equipment
- Consumer electronic peripherals
- Industrial process control systems
- Suitable for EIA RS-232 applications

**Features:**

- Oil-resistant (OIL RES I)
- Sunlight-resistant (SUN RES)
- Nylon ripcord
- UV-resistant

**Compliances:**

- NEC Article 725 Type PLTC-ER (22 AWG and larger, UL: 105°C, 300 V)
- (-ER): approved for Exposed Run as defined per NEC Article 725
- NEC Article 725 Type CL2 (UL: 105°C, 150 V)
- NEC Article 800 Type CM/CMG (UL: 105°C, 300 V)
- RoHS Compliant Directive 2015/863/EU (RoHS-3)

**Compliances: Flame & Smoke**

- Vertical Tray Cable Flame Test per UL 1581 and IEEE 383 (70,000 BTU)
- CSA FT4/IEEE 1202 flame test per UL 1685
- IEC 60332-1, 3, Cat A: Flammability
- IEC 61034-1, 2 and Mil-DTL-24643B and NES 711: Smoke Index Emission
- IEC 60754-1, 2 and Mil-DTL-24643B: Halogen Content and Acid Gas Generation

**Packaging:**

- Please contact Customer Service for packaging and color options
- Data subject to change.



# EXZEL® LSZH Multi-Paired, Foil Shielded

NEC Type CM, CMG, CL2 or PLTC-ER (UL)

**Product Construction:**

**Conductor:**

- Fully annealed stranded tinned copper per ASTM B33

**Insulation:**

- Premium-grade, color-coded LSZH (Thermoplastic Polyolefin)
- Color per Chart C for 24 AWG and 22 AWG on page 97
- Color per Chart D for 20 AWG and larger on page 97

**Shield:**

- 100% Flexfoil®, aluminum/polyester/aluminum, foil facing in
- Stranded tinned copper drain wire

**Jacket:**

- Premium FR-LSZH (Thermoplastic Polyolefin)
- Operating temperature range: -40°C to +105°C

**Applications:**

- Advanced signal transmission in controlled environments
- Medical instrumentation and equipment
- Consumer electronic peripherals
- Industrial process control systems
- Suitable for EIA RS-232 applications

**Features:**

- Oil-resistant (OIL RES I)
- Sunlight-resistant (SUN RES)
- Nylon ripcord
- UV-resistant

**Compliances:**

- NEC Article 725 Type PLTC-ER (22 AWG and larger, UL: 105°C, 300 V)
- (-ER): approved for Exposed Run as defined per NEC Article 725
- NEC Article 725 Type CL2 (UL: 105°C, 150 V)
- NEC Article 800 Type CM/CMG (UL: 105°C, 300 V)
- RoHS Compliant Directive 2015/863/EU (RoHS-3)

**Compliances: Flame & Smoke**

- Vertical Tray Cable Flame Test per UL 1581 and IEEE 383 (70,000 BTU)
- CSA FT4/IEEE 1202 flame test per UL 1685
- IEC 60332-1, 3, Cat A: Flammability
- IEC 61034-1, 2 and Mil-DTL-24643B and NES 711: Smoke Index Emission
- IEC 60754-1, 2 and Mil-DTL-24643B: Halogen Content and Acid Gas Generation

**Packaging:**

- Please contact Customer Service for packaging and color options
- Data subject to change.



PART NUMBER	PAIRS	AWG SIZE	COND. STRAND	NOMINAL INSULATION THICKNESS		NOMINAL JACKET THICKNESS		NOMINAL CABLE DIAMETER	
				in	mm	in	mm	in	mm
C9400ZH	1	24	7/32	0.010	0.25	0.032	0.81	0.165	4.19
C9401ZH	2	24	7/32	0.010	0.25	0.032	0.81	0.225	5.71
C9402ZH	3	24	7/32	0.010	0.25	0.032	0.81	0.236	5.99
C9403ZH	4	24	7/32	0.010	0.25	0.032	0.81	0.256	6.50
C9404ZH	5	24	7/32	0.010	0.25	0.037	0.94	0.287	7.28
C9405ZH	6	24	7/32	0.010	0.25	0.037	0.94	0.309	7.84
C9406ZH	9	24	7/32	0.010	0.25	0.037	0.94	0.355	9.01
C9407ZH	11	24	7/32	0.010	0.25	0.047	1.19	0.403	10.23
C9408ZH	15	24	7/32	0.010	0.25	0.047	1.19	0.454	11.54
C9410ZH	1	22	7/30	0.013	0.33	0.037	0.94	0.187	4.75
C9411ZH	2	22	7/30	0.013	0.33	0.037	0.94	0.255	6.48
C9412ZH	3	22	7/30	0.013	0.33	0.037	0.94	0.268	6.80
C9413ZH	4	22	7/30	0.013	0.33	0.042	1.07	0.300	7.63
C9414ZH	5	22	7/30	0.013	0.33	0.042	1.07	0.324	8.22
C9415ZH	6	22	7/30	0.013	0.33	0.042	1.07	0.349	8.86
C9416ZH	9	22	7/30	0.013	0.33	0.052	1.32	0.421	10.70
C9417ZH	11	22	7/30	0.013	0.33	0.052	1.32	0.453	11.51
C9418ZH	15	22	7/30	0.013	0.33	0.052	1.32	0.512	13.00
C9450ZH	1	20	7/28	0.016	0.41	0.037	0.94	0.227	5.77
C9420ZH	2	20	7/28	0.016	0.41	0.042	1.07	0.332	8.44
C9421ZH	3	20	7/28	0.016	0.41	0.042	1.07	0.350	8.89
C9451ZH	4	20	7/28	0.016	0.41	0.042	1.07	0.382	9.69
C9452ZH	5	20	7/28	0.016	0.41	0.052	1.32	0.435	11.04
C9422ZH	6	20	7/28	0.016	0.41	0.052	1.32	0.470	11.93
C9423ZH	9	20	7/28	0.016	0.41	0.052	1.32	0.543	13.78
C9424ZH	12	20	7/28	0.016	0.41	0.052	1.32	0.587	14.92
C9453ZH	15	20	7/28	0.016	0.41	0.062	1.57	0.690	17.52
C9454ZH	1	18	16/30	0.016	0.41	0.037	0.94	0.243	6.17
C9455ZH	2	18	16/30	0.016	0.41	0.042	1.07	0.359	9.12
C9426ZH	3	18	16/30	0.016	0.41	0.042	1.07	0.379	9.62
C9456ZH	4	18	16/30	0.016	0.41	0.052	1.32	0.434	11.03
C9457ZH	5	18	16/30	0.016	0.41	0.052	1.32	0.471	11.96
C9427ZH	6	18	16/30	0.016	0.41	0.052	1.32	0.510	12.96
C9458ZH	9	18	16/30	0.016	0.41	0.052	1.32	0.591	15.02
C9459ZH	12	18	16/30	0.016	0.41	0.062	1.57	0.681	17.29
C9460ZH	15	18	16/30	0.016	0.41	0.062	1.57	0.753	19.12

# EXZEL® LSZH Multi-Paired, Foil/Braid Shielded

NEC Type CM, CMG, CL2 or PLTC-ER (UL)



PART NUMBER	PAIRS	AWG SIZE	COND. STRAND	NOMINAL INSULATION THICKNESS		NOMINAL JACKET THICKNESS		NOMINAL CABLE DIAMETER	
				in	mm	in	mm	in	mm
C9500ZH	1	24	7/32	0.010	0.25	0.032	0.81	0.187	4.75
C9501ZH	2	24	7/32	0.010	0.25	0.032	0.81	0.247	6.27
C9502ZH	3	24	7/32	0.010	0.25	0.032	0.81	0.258	6.55
C9503ZH	4	24	7/32	0.010	0.25	0.037	0.94	0.288	7.31
C9504ZH	5	24	7/32	0.010	0.25	0.037	0.94	0.309	7.84
C9505ZH	6	24	7/32	0.010	0.25	0.037	0.94	0.331	8.40
C9506ZH	9	24	7/32	0.010	0.25	0.037	0.94	0.377	9.57
C9507ZH	11	24	7/32	0.010	0.25	0.047	1.19	0.425	10.79
C9508ZH	15	24	7/32	0.010	0.25	0.047	1.19	0.476	12.10
C9510ZH	1	22	7/30	0.013	0.33	0.037	0.94	0.209	5.31
C9511ZH	2	22	7/30	0.013	0.33	0.037	0.94	0.277	7.04
C9512ZH	3	22	7/30	0.013	0.33	0.042	1.07	0.300	7.61
C9513ZH	4	22	7/30	0.013	0.33	0.042	1.07	0.322	8.19
C9514ZH	5	22	7/30	0.013	0.33	0.042	1.07	0.346	8.78
C9515ZH	6	22	7/30	0.013	0.33	0.042	1.07	0.371	9.42
C9516ZH	9	22	7/30	0.013	0.33	0.052	1.32	0.443	11.25
C9517ZH	11	22	7/30	0.013	0.33	0.052	1.32	0.480	12.19
C9518ZH	15	22	7/30	0.013	0.33	0.052	1.32	0.539	13.69
C9529ZH	1	20	7/28	0.016	0.41	0.037	0.94	0.249	6.32
C9530ZH	2	20	7/28	0.016	0.41	0.042	1.07	0.354	9.00
C9521ZH	3	20	7/28	0.016	0.41	0.042	1.07	0.372	9.44
C9531ZH	4	20	7/28	0.016	0.41	0.052	1.32	0.424	10.76
C9532ZH	5	20	7/28	0.016	0.41	0.052	1.32	0.457	11.60
C9522ZH	6	20	7/28	0.016	0.41	0.052	1.32	0.497	12.62
C9523ZH	9	20	7/28	0.016	0.41	0.052	1.32	0.570	14.47
C9533ZH	12	20	7/28	0.016	0.41	0.062	1.57	0.652	16.56
C9534ZH	15	20	7/28	0.016	0.41	0.062	1.57	0.717	18.20
C9535ZH	1	18	16/30	0.016	0.41	0.037	0.94	0.265	6.73
C9525ZH	2	18	16/30	0.016	0.41	0.042	1.07	0.381	9.68
C9526ZH	3	18	16/30	0.016	0.41	0.052	1.32	0.421	10.69
C9536ZH	4	18	16/30	0.016	0.41	0.052	1.32	0.461	11.71
C9537ZH	5	18	16/30	0.016	0.41	0.052	1.32	0.498	12.64
C9527ZH	6	18	16/30	0.016	0.41	0.052	1.32	0.537	13.64
C9528ZH	9	18	16/30	0.016	0.41	0.062	1.57	0.638	16.21
C9538ZH	12	18	16/30	0.016	0.41	0.062	1.57	0.708	17.98
C9539ZH	15	18	16/30	0.016	0.41	0.062	1.57	0.780	19.81

**Product Construction:**

**Conductor:**

- Fully annealed stranded tinned copper per ASTM B33

**Insulation:**

- Premium-grade, color-coded LSZH (Thermoplastic Polyolefin)
- Color per Chart C for 24 AWG and 22 AWG on page 97
- Color per Chart D for 20 AWG and larger on page 97

**Shield:**

- Dual foil with overall braided shield
- Aluminum/polyester/aluminum foil with 100% coverage
- Stranded tinned copper drain wire
- Tinned copper braided shield, 85% min. coverage

**Jacket:**

- Premium FR-LSZH (Thermoplastic Polyolefin)
- Operating temperature range: -40°C to +105°C

**Applications:**

- Advanced signal transmission in controlled environments
- Medical instrumentation and equipment
- Consumer electronic peripherals
- Industrial process control systems
- Suitable for EIA RS-232 applications

**Features:**

- Oil-resistant (OIL RES I)
- Sunlight-resistant (SUN RES)
- Nylon ripcord
- UV-resistant

**Compliances:**

- NEC Article 725 Type PLTC-ER (22 AWG and larger, UL: 105°C, 300 V)
- (-ER): approved for Exposed Run as defined per NEC Article 725
- NEC Article 725 Type CL2 (UL: 105°C, 150 V)
- NEC Article 800 Type CM/CMG (UL: 105°C, 300 V)
- RoHS Compliant Directive 2015/863/EU (RoHS-3)

**Compliances: Flame & Smoke**

- Vertical Tray Cable Flame Test per UL 1581 and IEEE 383 (70,000 BTU)
- CSA FT4/IEEE 1202 flame test per UL 1685
- IEC 60332-1, 3, Cat A: Flammability
- IEC 61034-1, 2 and Mil-DTL-24643B and NES 711: Smoke Index Emission
- IEC 60754-1, 2 and Mil-DTL-24643B: Halogen Content and Acid Gas Generation

**Packaging:**

- Please contact Customer Service for packaging and color options
- Data subject to change.



# Color Code Charts

## MULTI-CONDUCTOR CABLES

NO. OF COND.	COLOR CHART A 24 AWG & 22 AWG	COLOR CHART B 20 AWG AND LARGER
	COLOR	COLOR
1	Black	Black
2	Brown	Red
3	Red	White
4	Orange	Green
5	Yellow	Orange
6	Green	Blue
7	Blue	Brown
8	Purple	Yellow
9	Slate	Purple
10	White	Slate
11	White/Black	Pink
12	White/Brown	Tan
13	White/Red	Red/Green
14	White/Orange	Red/Yellow
15	White/Yellow	Red/Black
16	White/Green	White/Black
17	White/Blue	White/Red
18	White/Purple	White/Green
19	White/Slate	White/Yellow
20	White/Black/Brown	White/Blue
21	White/Black/Red	White/Brown
22	White/Black/Orange	White/Orange
23	White/Black/Yellow	White/Slate
24	White/Black/Green	White/Purple
25	White/Black/Blue	White/Black/Red

## MULTI-PAIR CABLES

NO. OF PAIRS	COLOR CHART C 24 AWG & 22 AWG	COLOR CHART D 20 AWG AND LARGER
	COLOR	COLOR
1	White-Black	Black-Red
2	White-Brown	Black-White
3	White-Red	Black-Green
4	White-Orange	Black-Blue
5	White-Yellow	Black-Brown
6	White-Green	Black-Yellow
7	White-Blue	Black-Orange
8	White-Purple	Red-Green
9	White-Slate	Red-White
10	Black-Brown	Red-Blue
11	Black-Red	Red-Yellow
12	Black-Orange	Red-Brown
13	Black-Yellow	Red-Orange
14	Black-Green	Green-Blue
15	Black-Blue	Green-White

## IEC COLOR CHART

NO. OF COND.	COLOR
1	Brown
2	Blue
3	Green/Yellow

# Fire Alarm Cables

# 5



Fire alarm systems have expanded from a rather simple and unsophisticated business configured upon large, electro-mechanical devices to one relying upon the most modern technologies of microprocessor and chip technology.

More and more end users— industrial, commercial as well as consumer—are relying upon these emerging systems to protect both property and life. These systems are only as good as their weakest component, whether that component be a processor or interconnecting wire and cable.

It is Prysmian’s charter that all products supplied for use in these and any other systems shall be constructed of only the finest available materials, and provide the service and assurance that the end user not only needs, but requires.

Aside from the quality materials used in these designs, specifiers and end users of CAROL® Brand wire and cable products have come to expect that these cables are registered and certified with the leading regulatory agencies such as Underwriters Laboratories ... and we haven’t let you down!

These designs have proven themselves in the area of fire system security over time; all are fabricated with solid, bare copper conductors and insulations and jackets of premium-grade PVC. Offered both with and without shields, the former to protect these critical circuits from noise, these cables will provide the latest in available technology for the system installer and contractor.

Prysmian CAROL Brand products are conveniently packaged in 1000’ or 500’ lengths to assist the installer.

Section	Page
Multi-Conductor, Unshielded, Non-Plenum	81
Multi-Conductor, Unshielded, Non-Plenum (CSA)	82
Multi-Conductor, Shielded, Non-Plenum	83
Multi-Conductor, Shielded, Non-Plenum (CSA)	84
Multi-Conductor, Unshielded, Plenum	85-86
Multi-Conductor, Shielded, Plenum	87-88
Multi-Conductor, Shielded, Riser	89
Multi-Conductor, Unshielded, Riser	90
Mid-Capacitance, Unshielded, Non-Plenum	91
Mid-Capacitance, Shielded, Non-Plenum	92
Mid-Capacitance, Unshielded, Plenum	93
Mid-Capacitance, Shielded, Plenum	94

# Multi-Conductor, Unshielded, Non-Plenum

NEC Type FPLR and CL3R, NEC/CEC Type CMR

**Product Construction:**

**Conductor:**

- 22 thru 12 AWG fully annealed solid bare copper per ASTM B3

**Insulation:**

- Premium-grade, color-coded PVC
- Color code: See chart below

**Jacket:**

- Premium-grade PVC, red
- Suitable for use from -20°C to +105°C
- Round constructions have sequential footage markings to facilitate installation
- Includes ripcord on round constructions

**Applications:**

- Wiring of fire alarms
- Smoke detectors
- Voice communications
- Burglar alarms
- Fire protective circuits
- Suggested voltage rating: 300 volts

**Compliances:**

- NEC Article 760 Type FPLR (UL: 105°C, 300 V)
- NEC Article 725 Type CL3R (UL: 105°C, 300 V)
- NEC Article 800 Type CMR (UL: 105°C, 300 V)
- Suitable for use in the State of California
- RoHS Compliant Directive 2015/863/EU (RoHS3)

**Packaging:**

- Please contact Customer Service for packaging and color options

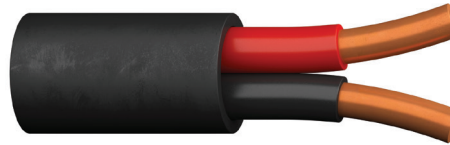

CATALOG NUMBER	NO. OF COND.	AWG SIZE	COND. STRAND	NOM. INSULATION THICKNESS		NOMINAL O.D.	
				in	mm	in	mm
E2402S	2	18	Solid	0.032	0.81	0.105 x 0.210	2.67 x 5.33
E2404S	2	16	Solid	0.032	0.81	0.115 x 0.230	2.92 x 5.84
E2406S	2	14	Solid	0.032	0.81	0.126 x 0.260	3.20 x 6.60

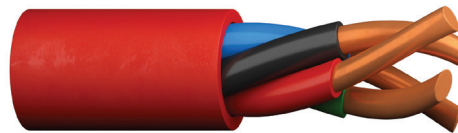

CATALOG NUMBER	NO. OF COND.	AWG SIZE	COND. STRAND	NOM. INSULATION THICKNESS		NOM. JACKET WALL		NOMINAL O.D.	
				in	mm	in	mm	in	mm
E1482S	2	22	Solid	0.010	0.25	0.015	0.38	0.121	3.07
E1484S	4	22	Solid	0.010	0.25	0.015	0.38	0.140	3.56
E1486S	6	22	Solid	0.010	0.25	0.015	0.38	0.168	4.27
E1502S	2	18	Solid	0.010	0.25	0.015	0.38	0.150	3.81
E1503S	3	18	Solid	0.010	0.25	0.015	0.38	0.160	4.06
E1504S	4	18	Solid	0.010	0.25	0.015	0.38	0.175	4.45
E1505S	5	18	Solid	0.010	0.25	0.015	0.38	0.193	4.90
E1506S	6	18	Solid	0.010	0.25	0.015	0.38	0.210	5.33
E1508S	8	18	Solid	0.010	0.25	0.015	0.38	0.230	5.84
E1512S	2	16	Solid	0.010	0.25	0.015	0.38	0.172	4.37
E1514S	4	16	Solid	0.010	0.25	0.015	0.38	0.202	5.13
E1522S*	2	14	Solid	0.013	0.33	0.015	0.38	0.210	5.33
E1524S*	4	14	Solid	0.013	0.33	0.015	0.38	0.248	6.30
E1532S*	2	12	Solid	0.013	0.33	0.015	0.38	0.244	6.20
E1534S*	4	12	Solid	0.013	0.33	0.015	0.38	0.288	7.32

\* NEC FPLR/CL3R only.  
Data subject to change.

**COLOR CODE CHART**

NO. OF COND.	COLOR
1	Black
2	Red
3	Brown
4	Blue
5	Orange
6	Yellow
7	Purple
8	Gray

# Multi-Conductor, Unshielded, Non-Plenum

CSA FAS105, FPL (UL), NEC Type PLTC

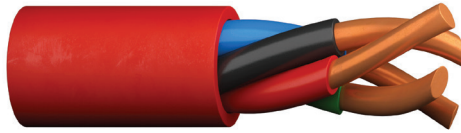

**Product Construction:**

**Conductor:**

- 22 thru 12 AWG fully annealed solid bare copper per ASTM B3

**Insulation:**

- Premium-grade PVC
- Color code: See page 206 for the CSA Fire Alarm Color Code Chart

**Jacket:**

- Premium-grade PVC, red
- Temperature range: -20°C to +105°C
- TRU-Mark® print legend contains footage markings from 1000' to 0'

**Applications:**

- Wiring of fire alarms
- Smoke alarms
- Voice communications
- Burglar alarms
- Fire protective circuits
- Suggested voltage rating: 300 volts

**Compliances:**

- NEC Article 725 PLTC (UL: 105°C, 300 V)
- NEC Article 760 Type FPL (UL: 105°C, 300 V)
- CSA FAS105 (CSA: 105°C, 300 V)
- C22.2 No. 208-03 (R2008) Weather (Sunlight) Resistant (1,000 HR)
- RoHS Compliant Directive 2015/863/EU (RoHS-3)
- Passes CSA FT4 Vertical Flame Test

**Packaging:**

- Please contact Customer Service for packaging and color options

CATALOG NUMBER	NO. OF COND.	AWG SIZE	COND. STRAND	NOM. INSULATION THICKNESS		NOM. JACKET WALL		NOMINAL O.D.	
				in	mm	in	mm	in	mm
C4300A	6	22	Solid	0.012	0.30	0.042	1.07	0.232	5.89
C4301A	15	22	Solid	0.012	0.30	0.042	1.07	0.316	8.03
C4302A	20	22	Solid	0.012	0.30	0.042	1.07	0.346	8.79
C4304A	2	18	Solid	0.015	0.38	0.042	1.07	0.225	5.71
C4305A	3	18	Solid	0.015	0.38	0.042	1.07	0.236	5.99
C4306A	4	18	Solid	0.015	0.38	0.042	1.07	0.255	6.47
C4307A	5	18	Solid	0.015	0.38	0.042	1.07	0.274	6.96
C4308A	6	18	Solid	0.015	0.38	0.042	1.07	0.296	7.52
C4309A	7	18	Solid	0.015	0.38	0.042	1.07	0.296	7.52
C4310A	8	18	Solid	0.015	0.38	0.042	1.07	0.317	8.05
C4312A	9	18	Solid	0.015	0.38	0.042	1.07	0.339	8.61
C4313A	10	18	Solid	0.015	0.38	0.042	1.07	0.366	9.30
C4314A	11	18	Solid	0.015	0.38	0.042	1.07	0.366	9.30
C4315A	15	18	Solid	0.015	0.38	0.053	1.35	0.437	11.10
C4316A	20	18	Solid	0.015	0.38	0.053	1.35	0.480	12.19
C4317A	21	18	Solid	0.015	0.38	0.053	1.35	0.480	12.19
C4318A	30	18	Solid	0.015	0.38	0.053	1.35	0.558	14.17
C4321A	2	16	Solid	0.015	0.38	0.042	1.07	0.246	6.25
C4322A	3	16	Solid	0.015	0.38	0.042	1.07	0.258	6.55
C4323A	4	16	Solid	0.015	0.38	0.042	1.07	0.280	7.11
C4349A	5	16	Solid	0.015	0.38	0.042	1.07	0.302	7.67
C4324A	2	14	Solid	0.015	0.38	0.042	1.07	0.272	6.91
C4325A	3	14	Solid	0.015	0.38	0.042	1.07	0.286	7.26
C4326A	4	14	Solid	0.015	0.38	0.042	1.07	0.311	7.90
C4327A	2	12	Solid	0.020	0.51	0.042	1.07	0.326	8.28

Data subject to change.





# Multi-Conductor, Shielded, Non-Plenum

NEC Type FPLR and CL3R, NEC/CEC Type CMR

**Product Construction:**

**Conductor:**

- 22 thru 12 AWG fully annealed solid bare copper per ASTM B3

**Insulation:**

- Premium-grade, color-coded PVC
- Color code: See chart below

**Shield:**

- Overall Flexfoil® polyester supported aluminum foil
- Stranded tinned copper drain wire

**Jacket:**

- Premium-grade PVC, red
- Temperature range: -20°C to +105°C
- Sequential footage markings to facilitate installation
- Includes ripcord

**Applications:**

- Wiring of fire alarms
- Smoke alarms
- Voice communications
- Burglar alarms
- Fire protective circuits
- Suggested voltage rating: 300 volts

**Compliances:**

- NEC Article 760 Type FPLR (UL: 105°C, 300 V)
- NEC Article 725 Type CL3R (UL: 105°C, 300 V)
- NEC Article 800 Type CMR (UL: 105°C, 300 V)
- Suitable for use in the State of California
- RoHS Compliant Directive 2015/863/EU (RoHS-3)

**Packaging:**

- Please contact Customer Service for packaging and color options

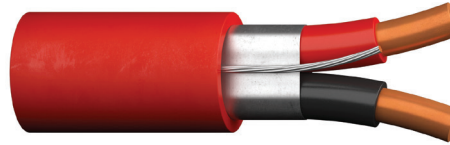

CATALOG NUMBER	NO. OF COND.	AWG SIZE	COND. STRAND	NOM. INSULATION THICKNESS		NOM. JACKET WALL		NOMINAL O.D.	
				in	mm	in	mm	in	mm
<b>E2482S</b>	2	22	Solid	0.010	0.25	0.015	0.38	0.126	3.20
<b>E2484S</b>	4	22	Solid	0.010	0.25	0.015	0.38	0.145	3.68
<b>E2502S</b>	2	18	Solid	0.010	0.25	0.015	0.38	0.158	4.01
<b>E2503S</b>	3	18	Solid	0.010	0.25	0.015	0.38	0.165	4.19
<b>E2504S</b>	4	18	Solid	0.010	0.25	0.015	0.38	0.183	4.65
<b>E2506S</b>	6	18	Solid	0.010	0.25	0.015	0.38	0.216	5.49
<b>E2508S</b>	8	18	Solid	0.010	0.25	0.015	0.38	0.235	5.97
<b>E2522S</b>	2	16	Solid	0.010	0.25	0.015	0.38	0.180	4.57
<b>E2524S</b>	4	16	Solid	0.010	0.25	0.015	0.38	0.210	5.33
<b>E2532S*</b>	2	14	Solid	0.013	0.33	0.015	0.38	0.218	5.54
<b>E2534S*</b>	4	14	Solid	0.013	0.33	0.015	0.38	0.253	6.43
<b>E2542S*</b>	2	12	Solid	0.013	0.33	0.015	0.38	0.252	6.40
<b>E2544S*</b>	4	12	Solid	0.013	0.33	0.015	0.38	0.293	7.44

\* NEC FPLR/CL3R only.  
Data subject to change.

**COLOR CODE CHART**

NO. OF COND.	COLOR
<b>1</b>	Black
<b>2</b>	Red
<b>3</b>	Brown
<b>4</b>	Blue
<b>5</b>	Orange
<b>6</b>	Yellow
<b>7</b>	Purple
<b>8</b>	Gray

# Multi-Conductor, Shielded, Non-Plenum

CSA FAS105, FPL (UL), NEC Type PLTC



**Product Construction:**

**Conductor:**

- 18-12 AWG fully annealed, solid bare copper per ASTM B3

**Insulation:**

- Premium-grade, color-coded PVC
- Color code: See page 206 for the CSA Fire Alarm Color Code Chart

**Shield:**

- 100% Flexfoil® aluminum/polyester with 25% overlap, foil facing out
- Stranded tinned copper drain wire

**Jacket:**

- Premium-grade PVC, red
- Temperature range: -20°C to +105°C
- TRU-Mark® print legend contains footage markings from 1000' to 0'

**Applications:**

- Wiring of fire alarms
- Smoke alarms
- Voice communications
- Burglar alarms
- Fire protective circuits
- Suggested voltage rating: 300 volts

**Compliances:**

- NEC Article 725 PLTC (UL: 105°C, 300 V)
- NEC Article 760 Type FPL (UL: 105°C, 300 V)
- CSA FAS105 (CSA: 105°C, 300 V)
- C22.2 No. 208-03 (R2008) Weather (Sunlight) Resistant (1,000 HR)
- RoHS Compliant Directive 2015/863/EU (RoHS-3)
- Passes CSA FT4 Vertical Flame Test

**Packaging:**

- Please contact Customer Service for packaging and color options

CATALOG NUMBER	NO. OF COND.	AWG SIZE	COND. STRAND	DRAIN WIRE AWG	NOM. INSULATION THICKNESS		NOM. JACKET THICKNESS		NOMINAL O.D.	
					in	mm	in	mm	in	mm
C4334A	2	18	Solid	22	0.015	0.38	0.042	1.07	0.230	5.84
C4335A	3	18	Solid	22	0.015	0.38	0.042	1.07	0.241	6.12
C4336A	4	18	Solid	22	0.015	0.38	0.042	1.07	0.260	6.60
C4337A	5	18	Solid	22	0.015	0.38	0.042	1.07	0.279	7.09
C4338A	6	18	Solid	22	0.015	0.38	0.042	1.07	0.301	7.65
C4339A	7	18	Solid	22	0.015	0.38	0.042	1.07	0.301	7.65
C4340A	8	18	Solid	22	0.015	0.38	0.042	1.07	0.322	8.18
C4341A	9	18	Solid	22	0.015	0.38	0.042	1.07	0.344	8.74
C4342A	10	18	Solid	22	0.015	0.38	0.042	1.07	0.371	9.42
C4343A	30	18	Solid	22	0.015	0.38	0.053	1.35	0.563	14.30
C4344A	2	16	Solid	22	0.015	0.38	0.042	1.07	0.251	6.37
C4345A	3	16	Solid	22	0.015	0.38	0.042	1.07	0.263	6.68
C4346A	4	16	Solid	22	0.015	0.38	0.042	1.07	0.285	7.24
C4350A	5	16	Solid	22	0.015	0.38	0.042	1.07	0.307	7.80
C4347A	2	14	Solid	16	0.015	0.38	0.042	1.07	0.277	7.04
C4348A	2	12	Solid	16	0.020	0.51	0.042	1.07	0.331	8.41

Data subject to change.



# Multi-Conductor, Unshielded, Plenum

NEC Type FPLP and CL3P, NEC/CEC Type CMP

**Product Construction:**

**Conductor:**

- 22 thru 12 AWG fully annealed solid bare copper per ASTM B3

**Insulation:**

- Premium-grade, color-coded Flexguard® PVC
- Color code: See chart below

**Jacket:**

- Premium-grade Flexguard® PVC, red
- Temperature range: 0°C to +75°C
- Sequential footage markings to facilitate installation
- Includes ripcord

**Applications:**

- Wiring of fire alarms
- Smoke detectors
- Voice communications
- Burglar alarms
- Fire protective circuits
- Suggested voltage rating: 300 volts

**Compliances:**

- NEC Article 760 Type FPLP (UL: 75°C, 300 V)
- NEC Article 725 Type CL3P (UL: 75°C, 300 V)
- NEC Article 800 Type CMP (UL: 75°C, 300 V)
- Suitable for use in the State of California
- RoHS Compliant Directive 2015/863/EU (RoHS-3)

**Packaging:**

- Please contact Customer Service for packaging and color options

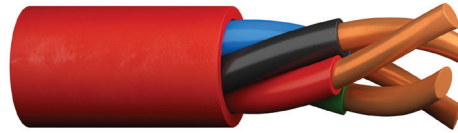

CATALOG NUMBER	NO. OF COND.	AWG SIZE	COND. STRAND	NOM. INSULATION THICKNESS		NOM. JACKET WALL		NOMINAL O.D.	
				in	mm	in	mm	in	mm
<b>E3482S</b>	2	22	Solid	0.010	0.25	0.015	0.38	0.121	3.07
<b>E3484S</b>	4	22	Solid	0.010	0.25	0.015	0.38	0.137	3.47
<b>E3502S</b>	2	18	Solid	0.010	0.25	0.015	0.38	0.155	3.81
<b>E3503S</b>	3	18	Solid	0.010	0.25	0.015	0.38	0.160	4.06
<b>E3504S</b>	4	18	Solid	0.010	0.25	0.015	0.38	0.175	4.45
<b>E3506S</b>	6	18	Solid	0.010	0.25	0.015	0.38	0.211	5.36
<b>E3512S</b>	2	16	Solid	0.010	0.25	0.015	0.38	0.172	4.37
<b>E3514S</b>	4	16	Solid	0.010	0.25	0.015	0.38	0.202	5.13
<b>E3522S*</b>	2	14	Solid	0.012	0.30	0.015	0.38	0.205	5.21
<b>E3524S*</b>	4	14	Solid	0.012	0.30	0.015	0.38	0.243	6.17
<b>E3532S*</b>	2	12	Solid	0.012	0.30	0.015	0.38	0.244	6.20
<b>E3534S*</b>	4	12	Solid	0.012	0.30	0.015	0.38	0.284	7.21

\* NEC FPLP/CL3P only.  
Data subject to change.

**COLOR CODE CHART**

NO. OF COND.	COLOR
<b>1</b>	Black
<b>2</b>	Red
<b>3</b>	Brown
<b>4</b>	Blue
<b>5</b>	Orange
<b>6</b>	Yellow



Designed to Meet  
NFPA 262 and CSA FT6  
Steiner Tunnel Fire Tests  
for Plenum Applications  
Underwriters Laboratories Inc.



# Multi-Conductor, Unshielded, Plenum

NEC/CEC Type CMP and/or NEC Type CL3P and FPLP

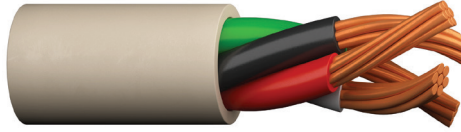

**Product Construction:**

**Conductor:**

- Stranded or solid bare copper per ASTM B3, B8 and B286

**Insulation:**

- Premium-grade, color-coded Flexguard® PVC
- Color code: See chart below

**Jacket:**

- Premium-grade Flexguard® PVC, natural
- Sequential footage markings to facilitate installation
- Temperature range: -20°C to +75°C

**Applications:**

- Power-limited control circuits
- Wiring of the following systems:
  - Intercom
  - Security
  - Audio
  - Background music
- Suggested voltage rating: 300 volts

**Compliances:**

- NEC Article 725 Type CL3P (UL: 75°C, 150 V)
- NEC Article 800 Type CMP (UL: 75°C, 300 V)
- NEC Article 760 Type FPLP (UL: 75°C, 300 V)
- Suitable for use in the State of California

**Packaging:**

- Please contact Customer Service for packaging and color options

CATALOG NUMBER	NO. OF COND.	AWG SIZE	COND. STRAND	NOM. INSULATION THICKNESS		NOM. JACKET WALL		NOMINAL O.D.	
				in	mm	in	mm	in	mm
E3000S	2	22	Solid	0.007	0.18	0.015	0.38	0.108	2.74
E3001S	4	22	Solid	0.007	0.18	0.015	0.38	0.124	3.15
E3002S	2	22	7/30	0.008	0.20	0.015	0.38	0.120	3.05
E3003S	3	22	7/30	0.008	0.20	0.015	0.38	0.127	3.23
E3004S	4	22	7/30	0.008	0.20	0.015	0.38	0.139	3.53
E3006S	6	22	7/30	0.008	0.20	0.015	0.38	0.164	4.17
E3008S	8	22	7/30	0.008	0.20	0.015	0.38	0.178	4.52
E3010S	10	22	7/30	0.008	0.20	0.015	0.38	0.194	4.92
E3012S	12	22	7/30	0.008	0.20	0.015	0.38	0.211	5.36
E3022S	2	20	7/28	0.009	0.23	0.015	0.20	0.134	3.40
E3023S	3	20	7/28	0.009	0.23	0.015	0.20	0.142	3.61
E3024S	4	20	7/28	0.009	0.23	0.015	0.20	0.156	3.96
E3030S	2	18	Solid	0.008	0.20	0.015	0.38	0.142	3.61
E3032S	2	18	7/26	0.008	0.20	0.015	0.38	0.156	3.96
E3033S	3	18	7/26	0.008	0.20	0.015	0.38	0.166	4.22
E3034S	4	18	7/26	0.008	0.20	0.015	0.38	0.187	4.75
E3036S	6	18	7/26	0.008	0.20	0.015	0.38	0.216	5.49
E3038S	8	18	7/26	0.008	0.20	0.015	0.38	0.235	5.97
E3042S	2	16	19/0117	0.008	0.20	0.015	0.38	0.174	4.42
E3043S	3	16	19/0117	0.008	0.20	0.015	0.38	0.185	4.70
E3044S	4	16	19/0117	0.009	0.23	0.008	0.20	0.205	5.21
E3052S*	2	14	19/0147	0.011	0.28	0.015	0.38	0.216	5.49
E3054S*	4	14	19/0147	0.011	0.28	0.015	0.38	0.255	6.48
E3062S*	2	12	19/0185	0.011	0.28	0.015	0.38	0.252	6.40
E3064S*	4	12	19/0185	0.011	0.28	0.015	0.38	0.298	7.57

\* NEC CL3P/FPLP only  
Data subject to change.

**COLOR CODE CHART**

NO. OF COND.	COLOR	NO. OF COND.	COLOR	NO. OF COND.	COLOR	NO. OF COND.	COLOR
1	Black	4	Green	7	Orange	10	Gray
2	Red	5	Brown	8	Yellow	11	Pink
3	White	6	Blue	9	Purple	12	Tan



# Multi-Conductor, Shielded, Plenum

NEC/CEC Type CMP and/or NEC Type CL3P and FPLP

**Product Construction:**

**Conductor:**

- Stranded or solid bare copper per ASTM B3, B8 and B286

**Insulation:**

- Premium-grade, color-coded Flexguard® PVC

**Shield:**

- Overall Flexfoil® polyester supported aluminum foil
- Stranded tinned copper drain wire

**Jacket:**

- Premium-grade Flexguard® PVC, natural
- Sequential footage markings to facilitate installation
- Temperature range: -20°C to +75°C

**Applications:**

- Power-limited control circuits
- Wiring of the following systems:
  - Intercom
  - Security
  - Audio
  - Background music
- Suggested voltage rating: 300 volts

**Compliances:**

- NEC Article 725 Type CL3P (UL: 75°C, 150 V)
- NEC Article 800 Type CMP (UL: 75°C, 300 V)
- NEC Article 760 Type FPLP (UL: 75°C, 300 V)
- Suitable for use in the State of California

**Packaging:**

- Please contact Customer Service for packaging and color options



CATALOG NUMBER	NO. OF COND.	AWG SIZE	COND. STRAND	NOM. INSULATION THICKNESS		NOM. JACKET WALL		NOMINAL O.D.	
				in	mm	in	mm	in	mm
E2100S	2	22	Solid	0.007	0.18	0.015	0.38	0.116	2.95
E2102S	2	22	7/30	0.008	0.20	0.015	0.38	0.128	3.25
E2103S	3	22	7/30	0.008	0.20	0.015	0.38	0.131	3.33
E2104S	4	22	7/30	0.008	0.20	0.015	0.38	0.147	3.73
E2106S	6	22	7/30	0.008	0.20	0.015	0.38	0.176	4.47
E2108S	8	22	7/30	0.008	0.20	0.015	0.38	0.184	4.67
E2110S	10	22	7/30	0.008	0.20	0.015	0.38	0.215	5.46
E2112S	12	22	7/30	0.008	0.20	0.015	0.38	0.222	5.64
E2122S	2	20	7/28	0.009	0.23	0.015	0.20	0.139	3.53
E2123S	3	20	7/28	0.009	0.23	0.015	0.20	0.147	3.73
E2124S	4	20	7/28	0.009	0.23	0.015	0.20	0.161	4.09
E2200S	2	18	Solid	0.008	0.20	0.015	0.38	0.148	3.76
E2202S	2	18	7/26	0.008	0.20	0.015	0.38	0.164	4.17
E2203S	3	18	7/26	0.008	0.20	0.015	0.38	0.169	4.29
E2204S	4	18	7/26	0.008	0.20	0.015	0.38	0.185	4.70
E2206S	6	18	7/26	0.010	0.25	0.008	0.20	0.218	5.54
E2208S	8	18	7/26	0.010	0.25	0.008	0.20	0.237	6.02
E2242S	2	16	19/0117	0.008	0.20	0.015	0.38	0.179	4.55
E2243S	3	16	19/0117	0.008	0.20	0.015	0.38	0.190	4.83
E2244S	4	16	19/0117	0.008	0.20	0.015	0.38	0.209	5.31
E2252S*	2	14	19/0147	0.008	0.20	0.011	0.28	0.235	5.97
E2254S*	4	14	19/0147	0.008	0.20	0.011	0.28	0.260	6.60
E2262S*	2	12	19/0185	0.008	0.20	0.011	0.28	0.257	6.53
E2264S*	4	12	19/0185	0.008	0.20	0.011	0.28	0.303	7.70

\* NEC CL3P/FPLP only  
Data subject to change.

**COLOR CODE CHART**

NO. OF COND.	COLOR	NO. OF COND.	COLOR	NO. OF COND.	COLOR	NO. OF COND.	COLOR
1	Black	4	Green	7	Orange	10	Gray
2	Red	5	Brown	8	Yellow	11	Pink
3	White	6	Blue	9	Purple	12	Tan



# Multi-Conductor, Shielded, Plenum

NEC Type FPLP



CATALOG NUMBER	NO. OF COND.	AWG SIZE	COND. STRAND	NOM. INSULATION THICKNESS		NOM. JACKET WALL		NOMINAL O.D.	
				in	mm	in	mm	in	mm
E3542S	2	22	Solid	0.010	0.25	0.015	0.38	0.126	3.20
E3602S	2	18	Solid	0.010	0.25	0.015	0.38	0.158	4.01
E3603S	3	18	Solid	0.010	0.25	0.015	0.38	0.165	4.19
E3604S	4	18	Solid	0.010	0.25	0.015	0.38	0.183	4.65
E3606S	6	18	Solid	0.010	0.25	0.015	0.38	0.216	5.49
E3612S	2	16	Solid	0.010	0.25	0.015	0.38	0.180	4.57
E3614S	4	16	Solid	0.010	0.25	0.015	0.38	0.210	5.33
E3622S	2	14	Solid	0.012	0.30	0.015	0.38	0.210	5.33
E3624S	4	14	Solid	0.012	0.30	0.015	0.38	0.248	6.30
E3632S	2	12	Solid	0.012	0.30	0.015	0.38	0.252	6.40
E3634S	4	12	Solid	0.012	0.30	0.015	0.38	0.300	7.62

Data subject to change.

**Product Construction:**

**Conductor:**

- 22 thru 12 AWG fully annealed solid bare copper per ASTM B3

**Insulation:**

- Premium-grade, color-coded Flexguard® PVC
- Color code: See chart below

**Shield:**

- Overall Flexfoil® polyester supported aluminum foil
- Stranded tinned copper drain wire

**Jacket:**

- Premium-grade Flexguard® PVC, red
- Suitable for use from 0°C to +75°C
- Sequential footage markings to facilitate installation
- Includes ripcord

**Applications:**

- Wiring of fire alarms
- Smoke detectors
- Voice communications
- Burglar alarms
- Fire protective circuits
- Suggested voltage rating: 300 volts

**Compliances:**

- NEC Article 760 Type FPLP (UL: 75°C, 300 V)
- NEC Article 725 Type CL3P (UL: 75°C, 300 V)
- NEC Article 800 Type CMP (UL: 75°C, 300 V)
- Suitable for use in the State of California
- Designed to meet NFPA 262 and CSA FT6 Steiner Tunnel Fire Tests for Plenum Applications

**Packaging:**

- Please contact Customer Service for packaging and color options

**COLOR CODE CHART**

NO. OF COND.	COLOR
1	Black
2	Red
3	Brown
4	Blue
5	Orange
6	Yellow



Designed to Meet  
NFPA 262 and CSA FT6  
Steiner Tunnel Fire Tests  
for Plenum Applications

Underwriters Laboratories Inc.



# Multi-Conductor, Unshielded, Riser

NEC/CEC Type CMR and/or NEC Type CL3R and FPLR

**Product Construction:**

**Conductor:**

- Stranded or solid bare copper per ASTM B3, B8 and B286

**Insulation:**

- Premium-grade, color-coded PVC
- Color code: See chart below

**Jacket:**

- Premium-grade PVC, gray
- Sequential footcage markings to facilitate installation
- Temperature range: -20°C to +105°C
- Includes ripcord

**Applications:**

- Power-limited control circuits
- Wiring of the following systems:
  - Intercom
  - Security
  - Audio
  - Background music
- Suggested voltage rating: 300 volts

**Compliances:**

- NEC Article 725 Type CL3R (UL: 105°C, 150 V)
- NEC Article 800 Type CMR (UL: 105°C, 300 V)
- NEC Article 760 Type FPLR (UL: 105°C, 300 V)
- RoHS Compliant Directive 2015/863/EU (RoHS-3)
- Suitable for use in the State of California

**Packaging:**

- Please contact Customer Service for packaging and color options

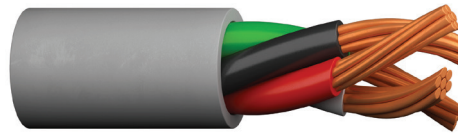

CATALOG NUMBER	NO. OF COND.	AWG SIZE	COND. STRAND	NOM. INSULATION THICKNESS		NOM. JACKET WALL		NOMINAL O.D.	
				in	mm	in	mm	in	mm
E1000S	2	22	Solid	0.007	0.20	0.015	0.38	0.118	3.00
E1001S	4	22	Solid	0.007	0.20	0.015	0.38	0.126	3.20
E1002S	2	22	7/30	0.008	0.20	0.015	0.38	0.122	3.10
E1003S	3	22	7/30	0.008	0.20	0.015	0.38	0.130	3.58
E1004S	4	22	7/30	0.008	0.20	0.015	0.38	0.141	3.66
E1006S	6	22	7/30	0.008	0.20	0.015	0.38	0.164	4.17
E1008S	8	22	7/30	0.008	0.20	0.015	0.38	0.180	4.57
E1010S	10	22	7/30	0.008	0.20	0.015	0.38	0.212	5.38
E1012S	12	22	7/30	0.008	0.20	0.015	0.38	0.219	5.56
E1022S	2	20	7/28	0.007	0.18	0.008	0.20	0.134	3.40
E1023S	3	20	7/28	0.008	0.20	0.015	0.38	0.142	3.61
E1024S	4	20	7/28	0.008	0.20	0.015	0.38	0.156	3.96
E1030S	2	18	Solid	0.008	0.20	0.015	0.38	0.144	3.66
E1032S	2	18	7/26	0.008	0.20	0.015	0.38	0.154	3.91
E1033S	3	18	7/26	0.008	0.20	0.015	0.38	0.163	4.14
E1034S	4	18	7/26	0.008	0.20	0.015	0.38	0.180	4.57
E1036S	6	18	7/26	0.008	0.20	0.015	0.38	0.216	5.49
E1038S	8	18	7/26	0.008	0.20	0.015	0.38	0.245	6.22
E1040S	10	18	7/26	0.008	0.20	0.015	0.38	0.282	7.16
E1041S	12	18	7/26	0.009	0.23	0.015	0.38	0.291	7.39
E1042S	2	16	19/0117	0.009	0.25	0.015	0.38	0.178	4.52
E1043S	3	16	19/0117	0.009	0.25	0.015	0.38	0.193	4.90
E1044S	4	16	19/0117	0.009	0.25	0.015	0.38	0.210	5.33
E1052S*	2	14	19/0147	0.013	0.33	0.015	0.38	0.224	5.69
E1054S*	4	14	19/0147	0.013	0.33	0.015	0.38	0.264	6.71
E1062S*	2	12	19/0185	0.013	0.33	0.015	0.38	0.260	6.60
E1064S*	4	12	19/0185	0.013	0.33	0.015	0.38	0.312	7.92

\* NEC CL3R/FPLR only  
Data subject to change.

**COLOR CODE CHART**

NO. OF COND.	COLOR	NO. OF COND.	COLOR	NO. OF COND.	COLOR	NO. OF COND.	COLOR
1	Black	4	Green	7	Orange	10	Gray
2	Red	5	Brown	8	Yellow	11	Pink
3	White	6	Blue	9	Purple	12	Tan



# Multi-Conductor, Shielded, Riser

NEC/CEC Type CMR and/or NEC Type CL3R and FPLR



**Product Construction:**

**Conductor:**

- Stranded or solid bare copper per ASTM B3, B8 and B286

**Insulation:**

- Premium-grade, color-coded PVC
- Color code: See chart below

**Shield:**

- Overall Flexfoil® polyester supported aluminum foil
- Stranded tinned copper drain wire

**Jacket:**

- Premium-grade PVC, gray
- Sequential footage markings to facilitate installation
- Temperature range: -20°C to +105°C
- Includes ripcord

**Applications:**

- Power-limited control circuits
- Wiring of the following systems:
  - Intercom
  - Security
  - Audio
  - Background music
- Suggested voltage rating: 300 volts

**Compliances:**

- NEC Article 725 Type CL3R (UL: 105°C, 300 V)
- NEC Article 800 Type CMR (UL: 105°C, 300 V)
- NEC Article 760 Type FPLR (UL: 105°C, 300 V)
- RoHS Compliant Directive 2015/863/EU (RoHS-3)
- Suitable for use in the State of California

**Packaging:**

- Please contact Customer Service for packaging and color options

CATALOG NUMBER	NO. OF COND.	AWG SIZE	COND. STRAND	NOM. INSULATION THICKNESS		NOM. JACKET WALL		NOMINAL O.D.	
				in	mm	in	mm	in	mm
E2000S	2	22	Solid	0.008	0.20	0.015	0.38	0.117	2.97
E2002S	2	22	7/30	0.008	0.20	0.015	0.38	0.132	3.35
E2003S	3	22	7/30	0.008	0.20	0.015	0.38	0.135	3.43
E2004S	4	22	7/30	0.008	0.20	0.015	0.38	0.147	3.73
E2006S	6	22	7/30	0.008	0.20	0.015	0.38	0.173	4.39
E2008S	8	22	7/30	0.008	0.20	0.015	0.38	0.195	4.95
E2010S	10	22	7/30	0.008	0.20	0.015	0.38	0.218	5.54
E2012S	12	22	7/30	0.010	0.25	0.008	0.20	0.222	5.64
E2022S	2	20	7/28	0.007	0.18	0.008	0.20	0.142	3.61
E2023S	3	20	7/28	0.007	0.18	0.008	0.20	0.151	3.84
E2024S	4	20	7/28	0.007	0.18	0.008	0.20	0.161	4.09
E2030S	2	18	Solid	0.009	0.20	0.008	0.20	0.147	3.73
E2032S	2	18	7/26	0.008	0.20	0.015	0.38	0.159	4.04
E2033S	3	18	7/26	0.008	0.20	0.015	0.38	0.168	4.27
E2034S	4	18	7/26	0.008	0.20	0.015	0.38	0.184	4.67
E2036S	6	18	7/26	0.008	0.20	0.015	0.38	0.221	5.61
E2038S	8	18	7/26	0.008	0.20	0.015	0.38	0.240	6.10
E2040S	10	18	7/26	0.008	0.20	0.015	0.38	0.287	7.29
E2041S	12	18	7/26	0.008	0.20	0.015	0.38	0.296	7.52
E2042S	2	16	19/0117	0.009	0.23	0.015	0.38	0.189	4.80
E2043S	3	16	19/0117	0.009	0.23	0.015	0.38	0.198	5.03
E2044S	4	16	19/0117	0.009	0.23	0.015	0.38	0.219	5.56
E2052S*	2	14	19/0147	0.013	0.33	0.015	0.38	0.245	6.22
E2054S*	4	14	19/0147	0.013	0.33	0.015	0.38	0.269	6.83
E2062S*	2	12	19/0185	0.013	0.33	0.015	0.38	0.281	7.14
E2064S*	4	12	19/0185	0.013	0.33	0.015	0.38	0.312	7.92

\* NEC CL3R/FPLR only  
Data subject to change.

**COLOR CODE CHART 5**

NO. OF COND.	COLOR	NO. OF COND.	COLOR	NO. OF COND.	COLOR	NO. OF COND.	COLOR
1	Black	4	Green	7	Orange	10	Gray
2	Red	5	Brown	8	Yellow	11	Pink
3	White	6	Blue	9	Purple	12	Tan





# Mid-Capacitance, Unshielded, Non-Plenum

NEC Type FPL for Microprocessor-Controlled Systems

**Product Construction:**

**Conductor:**

- 18 thru 12 AWG fully annealed solid bare copper per ASTM B3

**Insulation:**

- Premium-grade, color-coded polypropylene
- Color code: See chart below

**Jacket:**

- PVC, red
- Temperature range: -20°C to +75°C

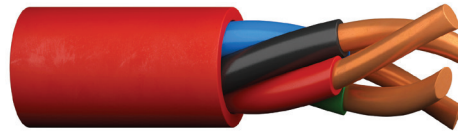

**Applications:**

- Addressable fire alarm systems
- Fire alarm systems
- Voice communications
- Smoke detectors
- Pull boxes
- Suggested voltage rating: 300 volts

**Compliances:**

- NEC Article 760 Type FPL
- Suitable for use in the State of California
- RoHS Compliant Directive 2015/863/EU (RoHS-3)

**Packaging:**

- Please contact Customer Service for packaging and color options

CATALOG NUMBER	NO. OF COND	AWG SIZE	COND. STRAND	NOM. INSULATION THICKNESS		NOM. JACKET THICKNESS		NOMINAL O.D.		NOM.* C-C CAP. pF/ft
				in	mm	in	mm	in	mm	
<b>C0471</b>	2	18	Solid	0.014	0.36	0.020	0.51	0.177	4.50	16.5
<b>C0485</b>	4	18	Solid	0.014	0.36	0.020	0.51	0.205	5.21	16.5
<b>C0473</b>	2	16	Solid	0.016	0.41	0.020	0.51	0.206	5.23	17.5
<b>C0486</b>	4	16	Solid	0.016	0.41	0.020	0.51	0.240	6.10	17.5
<b>C0491</b>	2	14	Solid	0.018	0.46	0.020	0.51	0.240	6.10	18.0
<b>C0492</b>	2	12	Solid	0.020	0.51	0.020	0.51	0.282	7.16	19.0

\*Capacitance between conductors  
Data subject to change.

**COLOR CODE CHART**

NO. OF COND.	COLOR
<b>1</b>	Black
<b>2</b>	Red
<b>3</b>	Brown
<b>4</b>	Blue

# Mid-Capacitance, Shielded, Non-Plenum

NEC Type FPL for Microprocessor-Controlled Systems



CATALOG NUMBER	NO. OF COND.	AWG SIZE	COND. STRAND	NOM. INSULATION THICKNESS		NOM. JACKET THICKNESS		NOMINAL O.D.		NOMINAL CAP. * pF/ft	
				in	mm	in	mm	in	mm	A	B
<b>C0472</b>	2	18	Solid	0.014	0.36	0.020	0.51	0.182	4.88	27.0	49.0
<b>C0494</b>	4	18	Solid	0.014	0.36	0.020	0.51	0.210	5.33	24.5	44.0
<b>C0474</b>	2	16	Solid	0.016	0.41	0.020	0.51	0.214	5.44	29.0	52.0
<b>C0495</b>	4	16	Solid	0.016	0.41	0.020	0.51	0.246	6.25	26.0	46.5
<b>C0475</b>	2	14	Solid	0.018	0.46	0.020	0.51	0.245	6.22	31.0	55.5
<b>C0496</b>	4	14	Solid	0.018	0.46	0.020	0.51	0.287	7.29	27.5	49.5
<b>C0476</b>	2	12	Solid	0.020	0.51	0.020	0.51	0.287	7.29	33.0	60.0
<b>C0497</b>	4	12	Solid	0.020	0.51	0.020	0.51	0.337	8.56	29.0	52.5

\*A - Capacitance between conductors

\*B - Capacitance between one conductor and other conductors connected to shield  
Data subject to change.

## COLOR CODE CHART

NO. OF COND.	COLOR
<b>1</b>	Black
<b>2</b>	Red
<b>3</b>	Brown
<b>4</b>	Blue

### Product Construction:

#### Conductor:

- 18 thru 12 AWG fully annealed solid bare copper per ASTM B3

#### Insulation:

- Premium-grade, color-coded polypropylene
- Color code: See chart below

#### Shield:

- 100% Flexfoil® aluminum/polyester, 25% overlap, minimum
- Stranded tinned copper drain wire

#### Jacket:

- PVC, red
- Temperature range: -20°C to +75°C

### Applications:

- Addressable fire alarm systems
- Fire alarm systems
- Voice communications
- Smoke detectors
- Pull boxes
- Suggested voltage rating: 300 volts

### Compliances:

- NEC Article 760 Type FPL
- Suitable for use in the State of California
- RoHS Compliant Directive 2015/863/EU (RoHS-3)

### Packaging:

- Please contact Customer Service for packaging and color options

# Mid-Capacitance, Unshielded, Plenum

NEC Type FPLP for Microprocessor-Controlled Systems

**Product Construction:**

**Conductor:**

- 18 thru 12 AWG fully annealed solid bare copper per ASTM B3

**Insulation:**

- Premium-grade, color-coded fluoropolymer
- Color code: See chart below

**Jacket:**

- Premium-grade Flexguard® PVC, red
- Temperature range: -20°C to +75°C
- Includes ripcord

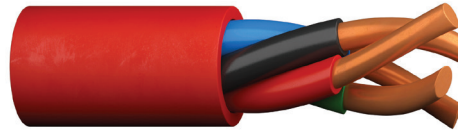

**Applications:**

- Addressable fire alarm systems
- Fire alarm systems
- Voice communications
- Smoke detectors
- Pull boxes
- Suggested voltage rating: 300 volts

**Compliances:**

- NEC Article 760 Type FPLP (UL: 75°C, 300 V)
- Suitable for use in the State of California

**Packaging:**

- Please contact Customer Service for packaging and color options

CATALOG NUMBER	NO. OF COND	AWG SIZE	COND. STRAND	NOM. INSULATION THICKNESS		NOM. JACKET THICKNESS		NOMINAL O.D.		NOM.* C-C CAP. pF/ft
				in	mm	in	mm	in	mm	
<b>C3240</b>	2	18	Solid	0.014	0.36	0.015	0.38	0.172	4.37	19.0
<b>C3242</b>	4	18	Solid	0.014	0.36	0.015	0.38	0.195	4.95	19.0
<b>C3241</b>	2	16	Solid	0.016	0.41	0.015	0.38	0.196	4.98	20.0
<b>C3243</b>	4	16	Solid	0.016	0.41	0.015	0.38	0.231	5.87	20.0
<b>C3244</b>	2	14	Solid	0.018	0.46	0.020	0.51	0.242	6.15	20.0
<b>C3245</b>	4	14	Solid	0.018	0.46	0.020	0.51	0.286	7.26	20.0
<b>C3246</b>	2	12	Solid	0.020	0.51	0.020	0.51	0.282	7.16	22.0
<b>C3247</b>	4	12	Solid	0.020	0.51	0.020	0.51	0.333	8.45	22.0

\*Capacitance between conductors  
Data subject to change.

**COLOR CODE CHART**

NO. OF COND.	COLOR
<b>1</b>	Black
<b>2</b>	Red
<b>3</b>	Brown
<b>4</b>	Blue



Designed to Meet  
NFPA 262 and CSA FT6  
Steiner Tunnel Fire Tests  
for Plenum Applications  
Underwriters Laboratories Inc.



# Mid-Capacitance, Shielded, Plenum

NEC Type FPLP for Microprocessor-Controlled Systems



CATALOG NUMBER	NO. OF COND.	AWG SIZE	COND. STRAND	NOM. INSULATION THICKNESS		NOM. JACKET THICKNESS		NOMINAL O.D.		NOMINAL CAP. * pF/ft	
				in	mm	in	mm	in	mm	A	B
<b>C3167</b>	2	18	Solid	0.014	0.36	0.015	0.38	0.172	4.37	31.0	56.0
<b>C3170</b>	4	18	Solid	0.014	0.36	0.015	0.38	0.202	5.13	28.0	50.0
<b>C3169</b>	2	16	Solid	0.016	0.41	0.015	0.38	0.203	5.16	33.0	59.0
<b>C3171</b>	4	16	Solid	0.016	0.41	0.015	0.38	0.238	6.05	29.0	53.0
<b>C3172</b>	2	14	Solid	0.018	0.46	0.020	0.51	0.247	6.27	35.0	63.0
<b>C3173</b>	4	14	Solid	0.018	0.46	0.020	0.51	0.289	7.34	30.0	56.0
<b>C3174</b>	2	12	Solid	0.020	0.51	0.020	0.51	0.289	7.34	38.0	68.0
<b>C3175</b>	4	12	Solid	0.020	0.51	0.020	0.51	0.340	8.64	33.0	60.0

\*A - Capacitance between conductors

\*B - Capacitance between one conductor and other conductors connected to shield  
Data subject to change.

## COLOR CODE CHART

NO. OF COND.	COLOR
1	Black
2	Red
3	Brown
4	Blue

## Product Construction

### Conductor:

- 18 thru 12 AWG fully annealed solid bare copper per ASTM B3

### Insulation:

- Premium-grade, color-coded fluoropolymer
- Color code: See chart below

### Shield:

- 100% Flexfoil® aluminum/polyester foil, 25% overlap, minimum
- Stranded tinned copper drain wire

### Jacket:

- Premium-grade Flexguard® PVC, red
- Temperature range: -20°C to +75°C
- Includes ripcord

## Applications:

- Addressable fire alarm systems
- Fire alarm systems
- Voice communications
- Smoke detectors
- Pull boxes
- Suggested voltage rating: 300 volts

## Compliances:

- NEC Article 760 Type FPLP (UL: 75°C, 300 V)
- Suitable for use in the State of California

## Packaging:

- Please contact Customer Service for packaging and color options



Designed to Meet  
NFPA 262 and CSA FT6  
Steiner Tunnel Fire Tests  
for Plenum Applications  
Underwriters Laboratories Inc.



# Sound, Alarm & Security Cable

# 6

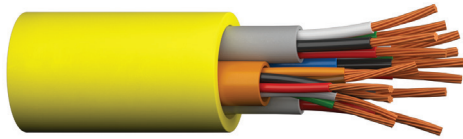

The sound and security industry in the United States has grown from a simple and unsophisticated business, begun some 45 years ago, to one which has developed technology to the degree that specialized wires and cables are now much in demand.

No longer are the security and sound industries characterized by large electromechanical relays and large contactors; today these circuits incorporate the latest in microprocessors and solid state devices to not only improve functionality but also to guarantee performance.

As a major wire producer, our role is to ensure that the wires and cables that go into these systems are as reliable as the other components...the net result is a fully integrated system which will provide peace of mind to the system user.

Also in this section are Prysmian's CAROL® Brand wire and cable designs suitable for a variety of applications, both in industrial and commercial environments, including telephone systems, intercoms, burglar alarms, business machines and thermostats.

Aside from the quality materials used in these designs, specifiers and users of CAROL Brand wire and cable products have come to expect that these cables are registered and certified with the leading regulatory agencies such as Underwriters Laboratories... and we haven't let you down!

CAROL Brand designs have proven themselves in the area of sound and security over time; most are fabricated with solid or stranded, bare copper conductors with insulations and jackets of premium grades of PVC. We offer both parallel and cabled designs both with and without shields. Sequential footage markings on the jackets are offered on all products.

Prysmian's CAROL Brand products are conveniently packaged in 1000' or 500' lengths to assist the installer.

Section	Page
Composite Access Control Cable, Plenum	96
Composite Access Control Cable, Riser	97
Multi-Conductor, Unshielded, Riser	98
Multi-Conductor, Shielded, Riser	99
Multi-Conductor, Unshielded, Plenum	100
Multi-Conductor, Shielded, Plenum	101
Telephone Station/Intercom & Speaker/Burglar Alarm	102
Thermostat Wire Type LVT	103
Thermostat Wire Type CL2	104
Thermostat Wire, Unjacketed	105

# Composite Access Control Cable, Plenum

NEC Type CMP, (UL), c(UL)

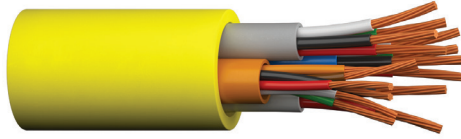

**Product Construction:**

**Conductor:**

- Stranded bare copper

**Jacket:**

- Flexguard® PVC
- Temperature range: 0°C to +60°C
- Individual elements marked for application (see diagram below)
- Yellow overall jacket

**Shields:**

- Choice between all 4 elements shielded or just the 3-pair element shielded

**Applications:**

- Security systems
- Access control
- Card reader
- Door control
- REX
- Power-limited controls

**Compliances:**

- NEC Article 800 Type CMP (UL), c(UL)
- RoHS Compliant Directive 2015/863/EU (RoHS-3)

**Packaging:**

- 500' and 1000' reels

CATALOG NUMBER	OVERALL NOMINAL O.D. INCH (MM)	COMPONENT NO.	COMPONENT DESCRIPTIONS	CONDUCTORS COLOR CODE	COMPONENT NOMINAL O.D. INCH (MM)	INSULATION THICKNESS INCH (MM)
4EPL4S	0.430	1	4 Cond, 18 AWG, Shielded	White, Black, Red, Green	0.180 (4.572)	0.008 (0.2032)
		2	3 Pair, 22 AWG, Shielded	White & Green, Orange & Brown, Red & Black	0.195 (4.953)	0.008 (0.2032)
		3	2 Cond, 22 AWG, Shielded	Red, Black	0.125 (3.175)	0.008 (0.2032)
		4	4 Cond, 22 AWG, Shielded	White, Black, Red, Green	0.145 (3.683)	0.008 (0.2032)
4EPLIS	0.420	1	4 Cond, 18 AWG, Unshielded	White, Black, Red, Green	0.180 (4.572)	0.008 (0.2032)
		2	3 Pair, 22 AWG, Shielded	White & Green, Orange & Brown, Red & Black	0.195 (4.953)	0.008 (0.2032)
		3	2 Cond, 22 AWG, Unshielded	Red, Black	0.125 (3.175)	0.008 (0.2032)
		4	4 Cond, 22 AWG, Unshielded	White, Black, Red, Green	0.145 (3.683)	0.008 (0.2032)

Data subject to change.

**JACKET COLOR CODING & COMPONENT APPLICATION**

Jacket Color	Component	Cable Type	Application
Gray	1	4 Conductor, 18 AWG	Lock Power
Orange	2	3 Pair, 22 AWG	Card Reader
White	3	2 Conductor, 22 AWG	Door Contact
Blue	4	4 Conductor, 22 AWG	Rex/Spare

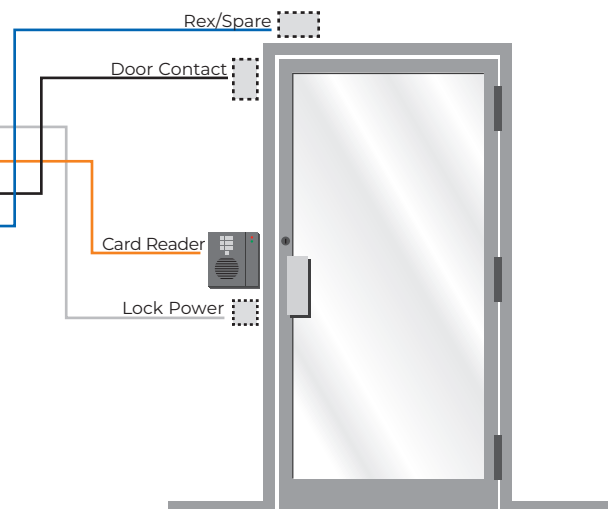

# Composite Access Control Cable, Riser

NEC Type CMR, (UL), c(UL)

**Product Construction:**

**Conductor:**

- Stranded bare copper

**Jacket:**

- PVC
- Temperature range: -20°C to +60°C
- Individual elements marked for application (see diagram below)
- Blue overall jacket

**Shields:**

- Choice between all 4 elements shielded or just the 3-pair shielded

**Applications:**

- Security systems
- Access control
- Card reader
- Door control
- REX
- Power-limited controls

**Compliances:**

- NEC Article 800 Type CMR (UL), c(UL)
- RoHS Compliant Directive 2015/863/EU (RoHS-3)

**Packaging:**

- 500' and 1000' reels

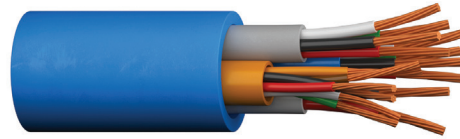

CATALOG NUMBER	OVERALL NOMINAL O.D. INCH (MM)	COMPONENT NO.	COMPONENT DESCRIPTIONS	CONDUCTORS COLOR CODE	COMPONENT NOMINAL O.D. INCH (MM)	INSULATION THICKNESS INCH (MM)
4ERS4S	0.430	1	4 Cond, 18 AWG, Shielded	White, Black, Red, Green	0.180 (4.572)	0.008 (0.2032)
		2	3 Pair, 22 AWG, Shielded	White & Green, Orange & Brown, Red & Black	0.195 (4.593)	0.008 (0.2032)
		3	2 Cond, 22 AWG, Shielded	Red, Black	0.125 (3.175)	0.008 (0.2032)
		4	4 Cond, 22 AWG, Shielded	White, Black, Red, Green	0.145 (3.683)	0.008 (0.2032)
4ERS1S	0.420	1	4 Cond, 18 AWG, Unshielded	White, Black, Red, Green	0.180 (4.572)	0.008 (0.2032)
		2	3 Pair, 22 AWG, Shielded	White & Green, Orange & Brown, Red & Black	0.195 (4.593)	0.008 (0.2032)
		3	2 Cond, 22 AWG, Unshielded	Red, Black	0.125 (3.175)	0.008 (0.2032)
		4	4 Cond, 22 AWG, Unshielded	White, Black, Red, Green	0.145 (3.683)	0.008 (0.2032)

Data subject to change.

**JACKET COLOR CODING & COMPONENT APPLICATION**

Jacket Color	Component	Cable Type	Application
Gray	1	4 Conductor, 18 AWG	Lock Power
Orange	2	3 Pair, 22 AWG	Card Reader
White	3	2 Conductor, 22 AWG	Door Contact
Blue	4	4 Conductor, 22 AWG	Rex/Spare

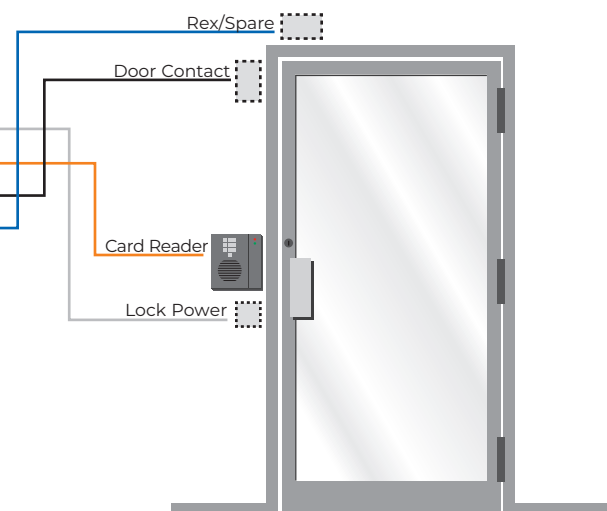

# Multi-Conductor, Unshielded, Riser

NEC/CEC Type CMR and/or NEC Type CL3R and FPLR

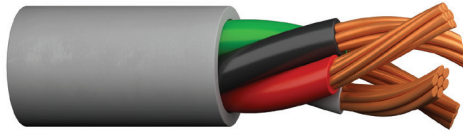

**Product Construction:**

**Conductor:**

- Stranded or solid bare copper per ASTM B3, B8 and B286

**Insulation:**

- Premium-grade, color-coded PVC
- Color code: See chart below

**Jacket:**

- Premium-grade PVC, gray
- Sequential footage markings to facilitate installation
- Temperature range: -20°C to +105°C
- Includes ripcord

**Applications:**

- Power-limited control circuits
- Wiring of the following systems:
  - Intercom
  - Security
  - Audio
  - Background music
- Suggested voltage rating: 300 volts

**Compliances:**

- NEC Article 725 Type CL3R (UL: 105°C, 150 V)
- NEC Article 800 Type CMR (UL: 105°C, 300 V)
- NEC Article 760 Type FPLR (UL: 105°C, 300 V)
- RoHS Compliant Directive 2015/863/EU (RoHS-3)
- Suitable for use in the State of California

**Packaging:**

- Please contact Customer Service for packaging and color options

CATALOG NUMBER	NO. OF COND.	AWG SIZE	COND. STRAND	NOM. INSULATION THICKNESS		NOM. JACKET WALL		NOMINAL O.D.	
				in	mm	in	mm	in	mm
E1000S	2	22	Solid	0.007	0.20	0.015	0.38	0.118	3.00
E1001S	4	22	Solid	0.007	0.20	0.015	0.38	0.126	3.20
E1002S	2	22	7/30	0.008	0.20	0.015	0.38	0.122	3.10
E1003S	3	22	7/30	0.008	0.20	0.015	0.38	0.130	3.58
E1004S	4	22	7/30	0.008	0.20	0.015	0.38	0.141	3.66
E1006S	6	22	7/30	0.008	0.20	0.015	0.38	0.164	4.17
E1008S	8	22	7/30	0.008	0.20	0.015	0.38	0.180	4.57
E1010S	10	22	7/30	0.008	0.20	0.015	0.38	0.212	5.38
E1012S	12	22	7/30	0.008	0.20	0.015	0.38	0.219	5.56
E1022S	2	20	7/28	0.007	0.18	0.008	0.20	0.134	3.40
E1023S	3	20	7/28	0.008	0.20	0.015	0.38	0.142	3.61
E1024S	4	20	7/28	0.008	0.20	0.015	0.38	0.156	3.96
E1030S	2	18	Solid	0.008	0.20	0.015	0.38	0.144	3.66
E1032S	2	18	7/26	0.008	0.20	0.015	0.38	0.154	3.91
E1033S	3	18	7/26	0.008	0.20	0.015	0.38	0.163	4.14
E1034S	4	18	7/26	0.008	0.20	0.015	0.38	0.180	4.57
E1036S	6	18	7/26	0.008	0.20	0.015	0.38	0.216	5.49
E1038S	8	18	7/26	0.008	0.20	0.015	0.38	0.245	6.22
E1040S	10	18	7/26	0.008	0.20	0.015	0.38	0.282	7.16
E1041S	12	18	7/26	0.009	0.23	0.015	0.38	0.291	7.39
E1042S	2	16	19/0117	0.009	0.25	0.015	0.38	0.178	4.52
E1043S	3	16	19/0117	0.009	0.25	0.015	0.38	0.193	4.90
E1044S	4	16	19/0117	0.009	0.25	0.015	0.38	0.210	5.33
E1052S*	2	14	19/0147	0.013	0.33	0.015	0.38	0.224	5.69
E1054S*	4	14	19/0147	0.013	0.33	0.015	0.38	0.264	6.71
E1062S*	2	12	19/0185	0.013	0.33	0.015	0.38	0.260	6.60
E1064S*	4	12	19/0185	0.013	0.33	0.015	0.38	0.312	7.92

\* NEC CL3R/FPLR only  
Data subject to change.

**COLOR CODE CHART**

NO. OF COND.	COLOR	NO. OF COND.	COLOR	NO. OF COND.	COLOR	NO. OF COND.	COLOR
1	Black	4	Green	7	Orange	10	Gray
2	Red	5	Brown	8	Yellow	11	Pink
3	White	6	Blue	9	Purple	12	Tan





# Multi-Conductor, Shielded, Riser

NEC/CEC Type CMR and/or NEC Type CL3R and FPLR

## Product Construction:

### Conductor:

- Stranded or solid bare copper per ASTM B3, B8 and B286

### Insulation:

- Premium-grade, color-coded PVC
- Color code: See chart below

### Shield:

- Overall Flexfoil® polyester supported aluminum foil
- Stranded tinned copper drain wire

### Jacket:

- Premium-grade PVC, gray
- Sequential footage markings to facilitate installation
- Temperature range: -20°C to +105°C
- Includes ripcord

### Applications:

- Power-limited control circuits
- Wiring of the following systems:
  - Intercom
  - Security
  - Audio
  - Background music
- Suggested voltage rating: 300 volts

### Compliances:

- NEC Article 725 Type CL3R (UL: 105°C, 300 V)
- NEC Article 800 Type CMR (UL: 105°C, 300 V)
- NEC Article 760 Type FPLR (UL: 105°C, 300 V)
- RoHS Compliant Directive 2015/863/EU (RoHS-3)
- Suitable for use in the State of California

### Packaging:

- Please contact Customer Service for packaging and color options

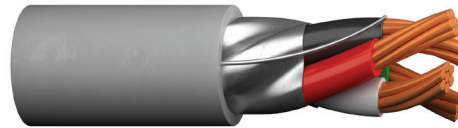

CATALOG NUMBER	NO. OF COND.	AWG SIZE	COND. STRAND	NOM. INSULATION THICKNESS		NOM. JACKET WALL		NOMINAL O.D.	
				in	mm	in	mm	in	mm
E2000S	2	22	Solid	0.008	0.20	0.015	0.38	0.117	2.97
E2002S	2	22	7/30	0.008	0.20	0.015	0.38	0.132	3.35
E2003S	3	22	7/30	0.008	0.20	0.015	0.38	0.135	3.43
E2004S	4	22	7/30	0.008	0.20	0.015	0.38	0.147	3.73
E2006S	6	22	7/30	0.008	0.20	0.015	0.38	0.173	4.39
E2008S	8	22	7/30	0.008	0.20	0.015	0.38	0.195	4.95
E2010S	10	22	7/30	0.008	0.20	0.015	0.38	0.218	5.54
E2012S	12	22	7/30	0.010	0.25	0.008	0.20	0.222	5.64
E2022S	2	20	7/28	0.007	0.18	0.008	0.20	0.142	3.61
E2023S	3	20	7/28	0.007	0.18	0.008	0.20	0.151	3.84
E2024S	4	20	7/28	0.007	0.18	0.008	0.20	0.161	4.09
E2030S	2	18	Solid	0.009	0.20	0.008	0.20	0.147	3.73
E2032S	2	18	7/26	0.008	0.20	0.015	0.38	0.159	4.04
E2033S	3	18	7/26	0.008	0.20	0.015	0.38	0.168	4.27
E2034S	4	18	7/26	0.008	0.20	0.015	0.38	0.184	4.67
E2036S	6	18	7/26	0.008	0.20	0.015	0.38	0.221	5.61
E2038S	8	18	7/26	0.008	0.20	0.015	0.38	0.240	6.10
E2040S	10	18	7/26	0.008	0.20	0.015	0.38	0.287	7.29
E2041S	12	18	7/26	0.008	0.20	0.015	0.38	0.296	7.52
E2042S	2	16	19/0117	0.009	0.23	0.015	0.38	0.189	4.80
E2043S	3	16	19/0117	0.009	0.23	0.015	0.38	0.198	5.03
E2044S	4	16	19/0117	0.009	0.23	0.015	0.38	0.219	5.56
E2052S*	2	14	19/0147	0.013	0.33	0.015	0.38	0.245	6.22
E2054S*	4	14	19/0147	0.013	0.33	0.015	0.38	0.269	6.83
E2062S*	2	12	19/0185	0.013	0.33	0.015	0.38	0.281	7.14
E2064S*	4	12	19/0185	0.013	0.33	0.015	0.38	0.312	7.92

\* NEC CL3R/FPLR only  
Data subject to change.

## COLOR CODE CHART 5

NO. OF COND.	COLOR	NO. OF COND.	COLOR	NO. OF COND.	COLOR	NO. OF COND.	COLOR
1	Black	4	Green	7	Orange	10	Gray
2	Red	5	Brown	8	Yellow	11	Pink
3	White	6	Blue	9	Purple	12	Tan



# Multi-Conductor, Unshielded, Plenum

NEC/CEC Type CMP and/or NEC Type CL3P and FPLP

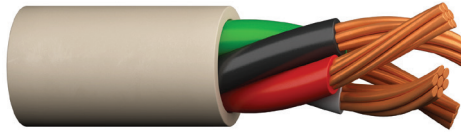

CATALOG NUMBER	NO. OF COND.	AWG SIZE	COND. STRAND	NOM. INSULATION THICKNESS		NOM. JACKET WALL		NOMINAL O.D.	
				in	mm	in	mm	in	mm
E3000S	2	22	Solid	0.007	0.18	0.015	0.38	0.108	2.74
E3001S	4	22	Solid	0.007	0.18	0.015	0.38	0.124	3.15
E3002S	2	22	7/30	0.008	0.20	0.015	0.38	0.120	3.05
E3003S	3	22	7/30	0.008	0.20	0.015	0.38	0.127	3.23
E3004S	4	22	7/30	0.008	0.20	0.015	0.38	0.139	3.53
E3006S	6	22	7/30	0.008	0.20	0.015	0.38	0.164	4.17
E3008S	8	22	7/30	0.008	0.20	0.015	0.38	0.178	4.52
E3010S	10	22	7/30	0.008	0.20	0.015	0.38	0.194	4.92
E3012S	12	22	7/30	0.008	0.20	0.015	0.38	0.211	5.36
E3022S	2	20	7/28	0.009	0.23	0.015	0.20	0.134	3.40
E3023S	3	20	7/28	0.009	0.23	0.015	0.20	0.142	3.61
E3024S	4	20	7/28	0.009	0.23	0.015	0.20	0.156	3.96
E3030S	2	18	Solid	0.008	0.20	0.015	0.38	0.142	3.61
E3032S	2	18	7/26	0.008	0.20	0.015	0.38	0.156	3.96
E3033S	3	18	7/26	0.008	0.20	0.015	0.38	0.166	4.22
E3034S	4	18	7/26	0.008	0.20	0.015	0.38	0.187	4.75
E3036S	6	18	7/26	0.008	0.20	0.015	0.38	0.216	5.49
E3038S	8	18	7/26	0.008	0.20	0.015	0.38	0.235	5.97
E3042S	2	16	19/0117	0.008	0.20	0.015	0.38	0.174	4.42
E3043S	3	16	19/0117	0.008	0.20	0.015	0.38	0.185	4.70
E3044S	4	16	19/0117	0.009	0.23	0.008	0.20	0.205	5.21
E3052S*	2	14	19/0147	0.011	0.28	0.015	0.38	0.216	5.49
E3054S*	4	14	19/0147	0.011	0.28	0.015	0.38	0.255	6.48
E3062S*	2	12	19/0185	0.011	0.28	0.015	0.38	0.252	6.40
E3064S*	4	12	19/0185	0.011	0.28	0.015	0.38	0.298	7.57

\* NEC CL3P/FPLP only  
Data subject to change.

**Product Construction:**

**Conductor:**

- Stranded or solid bare copper per ASTM B3, B8 and B286

**Insulation:**

- Premium-grade, color-coded Flexguard® PVC
- Color code: See chart below

**Jacket:**

- Premium-grade Flexguard® PVC, natural
- Sequential footage markings to facilitate installation
- Temperature range: -20°C to +75°C

**Applications:**

- Power-limited control circuits
- Wiring of the following systems:
  - Intercom
  - Security
  - Audio
  - Background music
- Suggested voltage rating: 300 volts

**Compliances:**

- NEC Article 725 Type CL3P (UL: 75°C, 150 V)
- NEC Article 800 Type CMP (UL: 75°C, 300 V)
- NEC Article 760 Type FPLP (UL: 75°C, 300 V)
- Suitable for use in the State of California

**Packaging:**

- Please contact Customer Service for packaging and color options

**COLOR CODE CHART**

NO. OF COND.	COLOR	NO. OF COND.	COLOR	NO. OF COND.	COLOR	NO. OF COND.	COLOR
1	Black	4	Green	7	Orange	10	Gray
2	Red	5	Brown	8	Yellow	11	Pink
3	White	6	Blue	9	Purple	12	Tan



# Multi-Conductor, Shielded, Plenum

NEC/CEC Type CMP and/or NEC Type CL3P and FPLP

**Product Construction:**

**Conductor:**

- Stranded or solid bare copper per ASTM B3, B8 and B286

**Insulation:**

- Premium-grade, color-coded Flexguard® PVC

**Shield:**

- Overall Flexfoil® polyester supported aluminum foil
- Stranded tinned copper drain wire

**Jacket:**

- Premium-grade Flexguard® PVC, natural
- Sequential footage markings to facilitate installation
- Temperature range: -20°C to +75°C

**Applications:**

- Power-limited control circuits
- Wiring of the following systems:
  - Intercom
  - Security
  - Audio
  - Background music
- Suggested voltage rating: 300 volts

**Compliances:**

- NEC Article 725 Type CL3P (UL: 75°C, 150 V)
- NEC Article 800 Type CMP (UL: 75°C, 300 V)
- NEC Article 760 Type FPLP (UL: 75°C, 300 V)
- Suitable for use in the State of California

**Packaging:**

- Please contact Customer Service for packaging and color options



CATALOG NUMBER	NO. OF COND.	AWG SIZE	COND. STRAND	NOM. INSULATION THICKNESS		NOM. JACKET WALL		NOMINAL O.D.	
				in	mm	in	mm	in	mm
E2100S	2	22	Solid	0.007	0.18	0.015	0.38	0.116	2.95
E2102S	2	22	7/30	0.008	0.20	0.015	0.38	0.128	3.25
E2103S	3	22	7/30	0.008	0.20	0.015	0.38	0.131	3.33
E2104S	4	22	7/30	0.008	0.20	0.015	0.38	0.147	3.73
E2106S	6	22	7/30	0.008	0.20	0.015	0.38	0.176	4.47
E2108S	8	22	7/30	0.008	0.20	0.015	0.38	0.184	4.67
E2110S	10	22	7/30	0.008	0.20	0.015	0.38	0.215	5.46
E2112S	12	22	7/30	0.008	0.20	0.015	0.38	0.222	5.64
E2122S	2	20	7/28	0.009	0.23	0.015	0.20	0.139	3.53
E2123S	3	20	7/28	0.009	0.23	0.015	0.20	0.147	3.73
E2124S	4	20	7/28	0.009	0.23	0.015	0.20	0.161	4.09
E2200S	2	18	Solid	0.008	0.20	0.015	0.38	0.148	3.76
E2202S	2	18	7/26	0.008	0.20	0.015	0.38	0.164	4.17
E2203S	3	18	7/26	0.008	0.20	0.015	0.38	0.169	4.29
E2204S	4	18	7/26	0.008	0.20	0.015	0.38	0.185	4.70
E2206S	6	18	7/26	0.010	0.25	0.008	0.20	0.218	5.54
E2208S	8	18	7/26	0.010	0.25	0.008	0.20	0.237	6.02
E2242S	2	16	19/0117	0.008	0.20	0.015	0.38	0.179	4.55
E2243S	3	16	19/0117	0.008	0.20	0.015	0.38	0.190	4.83
E2244S	4	16	19/0117	0.008	0.20	0.015	0.38	0.209	5.31
E2252S*	2	14	19/0147	0.008	0.20	0.011	0.28	0.235	5.97
E2254S*	4	14	19/0147	0.008	0.20	0.011	0.28	0.260	6.60
E2262S*	2	12	19/0185	0.008	0.20	0.011	0.28	0.257	6.53
E2264S*	4	12	19/0185	0.008	0.20	0.011	0.28	0.303	7.70

\* NEC CL3P/FPLP only  
Data subject to change.

**COLOR CODE CHART**

NO. OF COND.	COLOR	NO. OF COND.	COLOR	NO. OF COND.	COLOR	NO. OF COND.	COLOR
1	Black	4	Green	7	Orange	10	Gray
2	Red	5	Brown	8	Yellow	11	Pink
3	White	6	Blue	9	Purple	12	Tan



# Telephone Station/Intercom & Speaker Burglar Alarm

NEC Types CMR or CM/CL2 and CMX-Outdoor

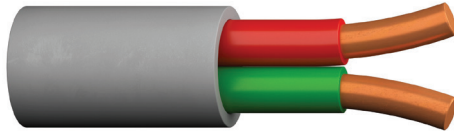

CATALOG NUMBER	NO. OF COND.	AWG SIZE	COND. STRAND	NOM. INSULATION THICKNESS		NOM. JACKET THICKNESS		NOMINAL O.D.	
				in	mm	in	mm	in	mm
<b>INTERCOM, SPEAKER AND BURGLAR ALARM</b>									
C4408*	2	22	Solid	0.007	0.18	0.020	0.51	0.115	2.92
C4408ST*	2	22	7/0096	0.007	0.18	0.020	0.51	0.125	3.18
C4410	3	22	Solid	0.007	0.18	0.016	0.41	0.118	3.00
C4412*	4	22	Solid	0.007	0.18	0.015	0.38	0.125	3.18
C4412ST*	4	22	7/0096	0.007	0.18	0.015	0.38	0.135	3.43

### COLOR CODE CHART

NO. OF COND.	COLOR
1	Red
2	Green
3	Yellow
4	Black

### TELEPHONE STATION CATEGORY 3

CATALOG NUMBER	NO. OF PAIRS	AWG SIZE	COND. STRAND	NOM. INSULATION THICKNESS		NOM. JACKET THICKNESS		NOMINAL O.D.	
				in	mm	in	mm	in	mm
C4413	2	24	Solid	0.007	0.18	0.015	0.38	0.145 x 0.095	3.68 x 2.41

Note: Outdoor rating allows cable to be exposed for short distances from the network interface device on the outside of the house to the point where the cable enters the house. This type of cable is not to be buried or direct buried.

Data subject to change.

### COLOR CODE CHART (Bandmarked)

NO. OF COND.	COLOR
1	White-Blue Band Blue
2	White-Orange Band Orange

### Product Construction:

#### Conductor:

- Solid or stranded bare copper per ASTM B3

#### Insulation:

- Semi-rigid, flame-retardant PVC
- Color code: See chart below

#### Core:

- Conductors in a quad configuration (C4412)

#### Jacket:

- Low-temperature, flame-retardant beige PVC (-20°C to +105°C)
- Sequential footage markings
- Cables are suitable for installation with T-18 staples

### Applications:

- Intercom systems and speaker extension service
- Suggested voltage rating: 300 volts
- C4413 only: Product is in conformance with TIA 568C, TIA 570B standards and the FCC Part 68 ruling which requires telephone system cables for voice and data services into homes to be at minimum category 3, 2 pr. 22 AWG solid

### Compliances:

- NEC Article 800 Type CMR/CMX-Indoor/Outdoor; UL Listed (105°C, 300 V)
- C4413 only, Category 3
- RoHS Compliant Directive 2015/863/EU (RoHS-3)

### Packaging:

- Please contact Customer Service for packaging and color options

# Thermostat Wire

60°C 30 Volt CSA Type LVT

**Product Construction:**

**Conductors:**

- 18 AWG annealed solid bare copper per ASTM B3

**Insulation:**

- Premium-grade, color-coded PVC
- Color code: See chart below

**Jacket:**

- Polyvinylchloride (PVC), brown
- Temperature range: -20°C to +60°C

**Jacket Marking:**

- CAROL (SIZE) CSA LL# TYPE LVT FT4

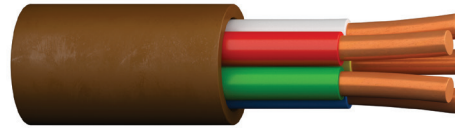

**Applications:**

- Thermostat control
- Heating and air conditioning installations
- Touch-plate systems
- Burglar alarms
- Intercom systems
- Door bells
- Annunciator and bell systems
- Remote control units
- Signal systems
- Other low-voltage installations

**Industry Approvals:**

- CSA Type LVT

**Packaging:**

- 4- through 10-conductor available on 250' (76.2 m) spools
- 2- and 3-conductor available on 500' (152.4 m) spools
- Other put-ups available on special order

**18 AWG THERMOSTAT WIRE – 30 VOLT – CSA TYPE LVT**

CATALOG NUMBER	NO. OF COND.	AWG SIZE	COND. STRAND	NOMINAL INS. THICKNESS		NOMINAL O.D.		APPROX. NET WEIGHT LBS/M <sup>(5)</sup>	STD. CTN.
				in	mm	in	mm		
05092	2	18	Solid	0.016	0.41	0.210	5.33	25	2000'
05093*	3	18	Solid	0.016	0.41	0.220	5.59	33	500'
05094	4	18	Solid	0.016	0.41	0.242	6.15	41	1000'
05095	5	18	Solid	0.016	0.41	0.262	6.65	50	1000'
05096*	6	18	Solid	0.016	0.41	0.280	7.11	60	1000'
05097*	7	18	Solid	0.016	0.41	0.285	7.24	65	1000'
05098	8	18	Solid	0.016	0.41	0.304	7.75	74	1000'
05099*	9	18	Solid	0.016	0.41	0.328	8.33	83	1000'
05091*	10	18	Solid	0.016	0.41	0.360	9.14	92	250'

\* Non-stock item; minimum quantity purchase required.

<sup>(5)</sup> Actual shipping weight may vary.

Data subject to change.

**COLOR CODE CHART**

NO. OF COND.	COLOR
2	White, Red
3	White, Red, Green
4	White, Red, Green, Blue
5	White, Red, Green, Blue, Yellow
6	White, Red, Green, Blue, Yellow, Brown
7	White, Red, Green, Blue, Yellow, Brown, Orange
8	White, Red, Green, Blue, Yellow, Brown, Orange, Black
9	White, Red, Green, Blue, Yellow, Brown, Orange, Black, Purple
10	White, Red, Green, Blue, Yellow, Brown, Orange, Black, Purple, Gray

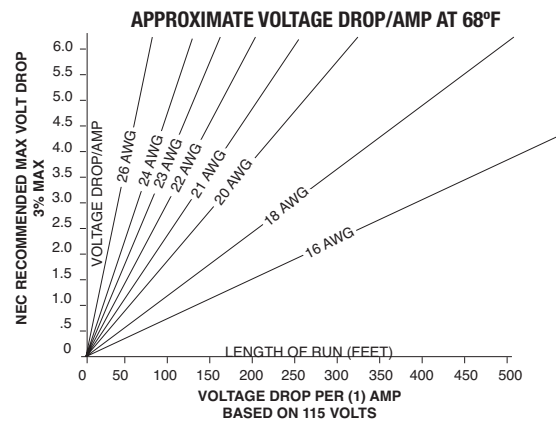

# Thermostat Wire

105°C 150 Volt UL Type CL2

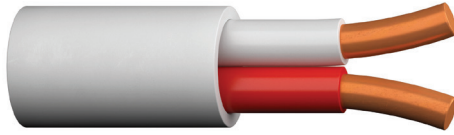

### 20 AWG THERMOSTAT WIRE – 150 VOLT – UL TYPE CL2

CATALOG NUMBER	NO. OF COND.	AWG SIZE	COND. STRAND	NOMINAL INS. THICKNESS		NOMINAL O.D.		APPROX. NET WEIGHT LBS/M <sup>(5)</sup>	STD. CTN.
				in	mm	in	mm		
05482	2	20	Solid	0.008	0.203	0.126	3.20	11	1000'
05483	3	20	Solid	0.008	0.203	0.133	3.38	16	1000'
05484	4	20	Solid	0.008	0.203	0.142	3.61	19	500'
05485	5	20	Solid	0.008	0.203	0.160	4.06	24	500'
05486	6	20	Solid	0.008	0.203	0.175	4.45	27	500'
05487	7	20	Solid	0.008	0.203	0.175	4.45	31	500'
05488	8	20	Solid	0.008	0.203	0.189	4.80	35	500'
05489*	9	20	Solid	0.008	0.203	0.204	5.18	40	500'
05481*	10	20	Solid	0.008	0.203	0.222	5.64	45	250'

### 18 AWG THERMOSTAT WIRE – 150 VOLT – UL TYPE CL2

CATALOG NUMBER	NO. OF COND.	AWG SIZE	COND. STRAND	NOMINAL INS. THICKNESS		NOMINAL O.D.		APPROX. NET WEIGHT LBS/M <sup>(5)</sup>	STD. CTN.
				in	mm	in	mm		
05582	2	18	Solid	0.008	0.203	0.142	3.61	16	1000'
05583	3	18	Solid	0.008	0.203	0.150	3.81	22	1000'
05584	4	18	Solid	0.008	0.203	0.165	4.19	28	500'
05585	5	18	Solid	0.008	0.203	0.181	4.60	36	500'
05586	6	18	Solid	0.008	0.203	0.208	5.28	42	500'
05587	7	18	Solid	0.008	0.203	0.208	5.28	48	500'
05588	8	18	Solid	0.008	0.203	0.225	5.72	54	500'
05589*	9	18	Solid	0.008	0.203	0.243	6.17	61	500'
05581	10	18	Solid	0.008	0.203	0.264	6.71	69	250'

<sup>(5)</sup> Actual shipping weight may vary.  
Data subject to change.

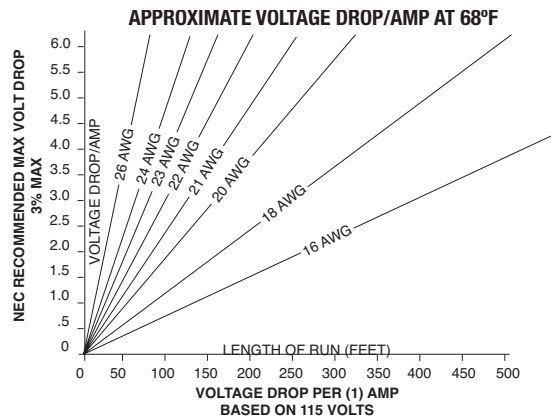

### COLOR CODE CHART

NO. OF COND.	COLOR
2	White, Red
3	White, Red, Green
4	White, Red, Green, Blue
5	White, Red, Green, Blue, Yellow
6	White, Red, Green, Blue, Yellow, Brown
7	White, Red, Green, Blue, Yellow, Brown, Orange
8	White, Red, Green, Blue, Yellow, Brown, Orange, Black
9	White, Red, Green, Blue, Yellow, Brown, Orange, Black, Purple
10	White, Red, Green, Blue, Yellow, Brown, Orange, Black, Purple, Gray

### Product Construction:

#### Conductors:

- 20 and 18 AWG annealed solid bare copper per ASTM B3

#### Insulation:

- Premium-grade, color-coded PVC
- Color code: See chart below

#### Jacket:

- Polyvinylchloride (PVC), white
- Temperature range: -20°C to +105°C

#### Jacket Marking:

- CAROL AWG TYPE CL2 E# (UL) 105°C SUNLIGHT RESISTANT - MADE IN USA

### Applications:

- Thermostat control
- Heating and air conditioning installations
- Touch-plate systems
- Burglar alarms
- Intercom systems
- Door bells
- Annunciator and bell systems
- Remote control units
- Signal systems
- Other low-voltage installations

### Industry Approvals:

- UL Listed Type CL2
- RoHS Compliant

### Packaging:

- 4- through 10-conductor available on 250' (76.2 m) spools
- 2- and 3-conductor available on 500' (152.4 m) spools
- Other put-ups available on special order



# Thermostat Wire, Unjacketed

## 60°C Low Voltage and Intercom Cable

**Product Construction:**

**Conductors:**

- 20 AWG annealed solid bare copper per ASTM B3

**Insulation:**

- Premium-grade, color-coded PVC
- Temperature range: -20°C to +60°C
- Color code: See chart below

**Jacket:**

- This product is unjacketed

**Applications:**

- Thermostat control
- Heating and air conditioning installations
- Touch-plate systems
- Burglar alarms
- Intercom systems
- Door bells
- Annunciator and bell systems
- Remote control units
- Signal systems
- Other low-voltage installations

**Packaging:**

- 4- through 8-conductor available on 250' (76.2 m) spools
- 2- and 3-conductor available on 500' (152.4 m) spools
- Other put-ups available on special order



**20 AWG – TWISTED CONDUCTORS – NO JACKET**

CATALOG NUMBER	NO. OF COND.	AWG SIZE	COND. STRAND	NOMINAL INS. THICKNESS		NOMINAL O.D.		APPROX. NET WEIGHT LBS/M <sup>(5)</sup>	STD. CTN.
				in	mm	in	mm		
<b>05782</b>	2	20	Solid	0.008	0.203	0.096	2.44	7.5	4000'
<b>05783</b>	3	20	Solid	0.008	0.203	0.104	2.64	11.0	2000'
<b>05784*</b>	4	20	Solid	0.008	0.203	0.116	2.95	15.0	2000'
<b>05785*</b>	5	20	Solid	0.008	0.203	0.130	3.30	18.5	1000'
<b>05786*</b>	6	20	Solid	0.008	0.203	0.144	3.66	22.0	1000'
<b>05788*</b>	8	20	Solid	0.008	0.203	0.159	4.04	30.0	1000'

\* Non-stock item; minimum quantity purchase required.  
<sup>(5)</sup> Actual shipping weight may vary.  
 Data subject to change.

**COLOR CODE CHART**

NO. OF COND.	COLOR
<b>2</b>	White, Red
<b>3</b>	White, Red, Green
<b>4</b>	White, Red, Green, Blue
<b>5</b>	White, Red, Green, Blue, Yellow
<b>6</b>	White, Red, Green, Blue, Yellow, Brown
<b>7</b>	White, Red, Green, Blue, Yellow, Brown, Orange
<b>8</b>	White, Red, Green, Blue, Yellow, Brown, Orange, Black

# Category Cables

## 7

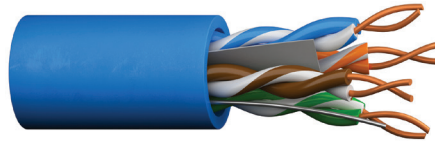

For more than a century and a half, Prysmian has stayed ahead of the industry's changing needs with products that anticipate future performance requirements and provide best value in cabling solutions. With the ever-increasing need for readily available information in our lives, CAROL® Brand Category Cables transmit data through computer and telecommunications systems and are available in a variety of performance levels and constructions, including Category 6 and Category 5e cables.

Prysmian's Carol® MAX Category 6 Cable is a cost effective, extended distance 22 AWG cable that provides power and bandwidth beyond IEEE standards. Perfect for making it easier to connect complex network systems with high-powered PoE capabilities. Carol® 6 MAX delivers 1 Gbps at up to 200 meters certified by Third Party Testers.

Next, our Category 6 cables have been enhanced to provide the market with a cost-effective, high-bandwidth and high-performance cabling solution for more robust and complex applications at Gigabit speed and full duplex transmissions. Our Cat 6 solutions provides a cable system infrastructure with assurance for advanced applications demanding more bandwidth.

Finally, with steady, continuous performance, our Category 5e solutions meet all Cat 5e requirements for present and future network requirements ensuring increased headroom, lower bit-error rates and higher signal transmission quality.

All CAROL Brand Category Cables are safety listed to the NEC and CEC requirements, and most are verified for electrical performance. This independent third party testing further confirms the quality and performance of Prysmian products.

Section	Page
Category 6 Cable - Carol MAX	107-108
Category 6 Cable	109
Category 5e Cable	110



# Category 6 Cable – Carol MAX

Extended Distance (22 AWG)

**Product Construction:**

**Conductors:**

- 22 AWG solid bare annealed copper

**Separator:**

- CMP: Divider
- OSP: Cross-web

**Insulation:**

- CMP: Fluoropolymer
- OSP: Polyolefin

**Jacket:**

- CMP: Low-Smoke, Flame-Retardant PVC
- OSP: UV- and abrasion-resistant polyethylene

**Applications:**

- IEEE 802.3; 1000 Base-T, 100 Base-TX, 10 Base-T, PoE, PoE+, PoE++
- ANSI/TIA 854; 1000 Base-TX
- CDDI, Token Ring, ATM
- Digital Video
- Broadband a Baseband Analog Video
- OSP: Duct and conduit installations
- Supports the growth of higher-wattage devices (IT/IP, IoT, and IoE)
- CMP: Compatible with new higher-speed, higher-power USB 3.1 SuperSpeed

**Compliances:**

- ANSI/TIA 568.2-D
- CMP: TIA TSB-184:2009
- UL 444
- RoHS Compliant Directive 2011/65 EU
- ANSI/TIA 862 (Building Automation)
- ICEA S-116-732
- ICEA S-102-700
- ISO/IEC 11801 Ed. 2.0 (Class E)
- OSP: Telcordia (Bellcore) Specification GR-421-CORE Water Penetration Requirement

**Packaging:**

- 1000' Spool-Pac®



**PART NUMBERS**

JACKET COLOR	CMP (Plenum)		OSP (Outside Plant)
	PULL-PAC®	SPOOL-PAC®	SPOOL-PAC®
Blue	CP622.30.07	CP622.A3.07	N/A
White	CP622.30.02	CP622.A3.02	N/A
Gray	CP622.30.10	CP622.A3.10	N/A
Green	CP622.30.06	CP622.A3.06	N/A
Yellow	CP622.30.05	CP622.A3.05	N/A
Red	CP622.30.03	CP622.A3.03	N/A
Black	CP622.30.01	CP622.A3.01	CX622.A3.01

**ELECTRICAL PERFORMANCE**

FREQUENCY MHZ	PSACR (MIN)	ACR (MIN)	INSERTION LOSS (MAX)	PSNEXT (MIN)	NEXT (MIN)	RETURN LOSS (MIN)	TCL (MIN)
1	70.4	72.4	1.9	72.3	74.3	20.0	40.0
4	59.8	61.8	3.5	63.3	65.3	23.0	40.0
10	51.8	53.8	5.5	57.3	59.3	25.0	40.0
16	47.2	49.2	7.0	54.2	56.2	25.0	38.0
20	44.9	46.9	7.9	52.8	54.8	25.0	37.0
31.25	40.0	42.0	9.9	49.9	51.9	23.6	35.1
62.5	31.1	33.1	14.3	45.4	47.4	21.5	32.0
100	23.9	25.9	18.4	42.3	44.3	20.1	28.2
150	16.7	18.7	23.0	39.7	41.7	18.9	27.0
200	10.8	12.8	27.0	37.8	39.8	18.0	26.0
250	5.7	7.7	30.6	36.3	38.3	17.3	-

Note: Values are expressed in dB per 100m (328 ft.) length @ 20° C.

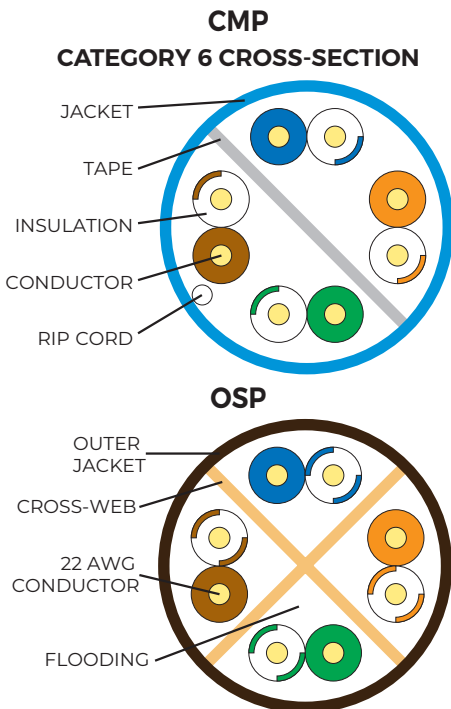

**PHYSICAL DATA**

	PLENUM	OSP
<b>Nominal Cable Diameter (in)</b>	0.245	0.295
<b>Nominal Cable Weight (lbs/1000ft)</b>	38	40
<b>Minimum Bend Radius (in)</b>	1.0	1.0
<b>Maximum Pulling Force (lbs)</b>	32	32
<b>Temperature Rating (°C)</b>		
<b>Installation:</b>	0 to +60	-30 to +60
<b>Operation:</b>	-20 to +75	-45 to +80

**ELECTRICAL CHARACTERISTICS**

	MAX	OSP
<b>DC Resistance</b> Ohms/100m (328ft) @ 20° C	9.38	6.50
<b>DC Resistance Unbalance</b> Individual Pair %	4.00	< 1
<b>Delay Skew</b> ns/100m	45	35
<b>Nom. Velocity of Propagation</b> % Speed of Light	CMP: 72% OSP: 66%	
<b>Characteristic Impedance</b> Frequency (f):	1-350 MHz	Ohms 100 ± 15



# Carol MAX

Cat 6 Extended Distance (22 AWG)

FEATURING  
**EFFICIENCY MAX**<sup>®</sup>  
technology to support PoE applications

Carol<sup>®</sup> 6 MAX Category 6 (22 AWG) cables provide maximum versatility to challenging installations with a Plenum and Outside Plant cable option. The cable meets all Category 6 requirements under 100 meters. It also provides power and bandwidth at extended distances beyond the IEEE standard. The same industry-trusted high-powered PoE cable that has been in the market since 2015 is now guaranteed to meet your extended distance needs.

### Primary enhancement—larger copper (22 AWG)

- Less voltage drop
- Increased current-carrying capacity
- Performs better in hotter environments (less heat generation)

CAROL<sup>®</sup> 6 MAX delivers  
1 Gbps at up to  
200 meters certifiable  
by Third Party Testers

**Exceeds the 100-meter Category Cable limitations distance while meeting all your application needs:**



**ITC**

AV SYSTEMS  
IP PHONES



**SECURITY**

4K CAMERAS  
ACCES CONTROL



**IoT DEVICES**

RETAIL  
TEMPERATURE/HUMIDITY CONTROLS



**BUILDING AUTOMATION**

PARKING SYSTEMS  
BUILDING SYSTEMS

**Performance expectations can vary based on application and temperature. The below table is a guide to the max distance in your installation:**

Type 1 PoE (802.3af) up to 15.4W – ex. VoIP and Cameras

Type 2 PoE (802.3at) up to 30W – ex. Video IP Phones, Alarm Systems, Heated / PTZ Cameras

Type 3/Type 4 PoE (802.3bt) up to 60W/90W – ex. WiFi, Laptops, 8k Cameras

CAROL <sup>®</sup> MAX Cable**	PoE @ Ambient Temp			
	Type 1	Type 2	Type 3	Type 4
<b>Max Distance @ 10 Mbps</b>	274m	250m	250m	250m
<b>Max Distance @ 100 Mbps</b>	230m	230m	230m	230m
<b>Max Distance @ 1Gbps</b>	200m	200m	200m	200m

\*\*Maximum distance is subject to change based on manufacturer's equipment and other environmental conditions.

# Category 6 Cable

## Standard-Compliant Solution

**Product Construction:**

**Conductors:**

- Non-Plenum: 23 AWG sold bare annealed copper
- Plenum: 24 AWG sold bare annealed copper

**Insulation:**

- Non-Plenum: Polyolefin
- Plenum: Fluoropolymer

**Separator:**

- Tape

**Rip Cord:**

- Applied longitudinally under jacket

**Jacket:**

- Non-Plenum: flame-retardant PVC
- Plenum: low-smoke, flame-retardant PVC
- TRU-Mark® print legend contains footage markings from 1000' to 0'

**Applications:**

- IEEE 802.3: 1000 BASE-T (Gigabit Ethernet), 100 BASE-TX, 10 BASE-T
- ANSI/TIA/EIA 854: 1000 BASE-TX
- 155 Mp/s, 1.2 Gb/s ATM
- ANSI X3.263: 100 Mb/s
- IEEE 802.3af DTE Power (PoE)
- Digital video

**Compliances:**

- ANSI/TIA 568 B.2-1 (Category 6)
- ANSI/TIA 862 (Building Automation)
- ISO/IEC 11801 Ed. 2.0 (Class E)
- ICEA S-102-700 (Category 6)
- Type CMP (NFPA 262 and CSA FT6 Steiner Tunnel Fire Tests for Plenum Applications)
- UL 444
- NEC/CEC Type CMP (NFPA 262 and CSA FT6 Steiner Tunnel Fire Tests for Plenum Applications)
- NEC/CEC Type CMR (UL 1666) for Non-Plenum
- RoHS Compliant Directive 2011/65/EU
- Third-party verified for guaranteed performance

**Packaging:**

- 1000' Pull-Pac® II
- 1000' Spool-Pac®

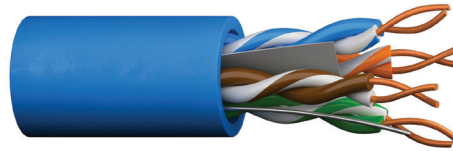

**PART NUMBERS**

JACKET COLOR	PULL-PAC® II		SPOOL-PAC®	
	CMR (NON-PLENUM)	CMP (PLENUM)	CMR (NON-PLENUM)	CMP (PLENUM)
Blue	CR6.30.07	CP6.30.07	CR6.A3.07	CP6.A3.07
White	CR6.30.02	CP6.30.02	CR6.A3.02	CP6.A3.02
Gray	CR6.30.10	CP6.30.10	CR6.A3.10	CP6.A3.10
Green	CR6.30.06	CP6.30.06	CR6.A3.06	CP6.A3.06
Yellow	CR6.30.05	CP6.30.05	CR6.A3.05	CP6.A3.05
Red	CR6.30.03	CP6.30.03	CR6.A3.03	CP6.A3.03

**ELECTRICAL PERFORMANCE**

FREQUENCY MHZ	PSACR (MIN)	ACR (MIN)	ATTENUATION (MAX)	PSNEXT (MIN)	NEXT (MIN)	PSELFEXT (MIN)	ELFEXT (MIN)	RETURN LOSS (MIN)	LCL (MIN)	ELTCTL (MIN)
1	70.3	72.3	2.0	72.3	74.3	64.8	67.8	20.0	40.0	35.0
4	59.3	61.5	3.8	63.3	65.3	52.8	55.7	23.0	40.0	23.0
10	51.3	53.3	6.0	57.3	59.3	44.8	47.8	25.0	40.0	15.0
16	46.7	48.7	7.6	54.2	56.2	40.7	43.7	25.0	38.0	10.9
20	44.3	46.3	8.5	52.8	54.8	38.8	41.7	25.0	37.0	9.0
31.25	39.2	41.2	10.7	49.9	51.9	34.9	37.9	23.6	35.1	5.1
62.5	29.9	32.0	15.4	45.4	47.4	28.9	31.8	21.5	32.0	5.0
100	22.5	24.5	19.8	42.3	44.3	24.8	27.8	20.1	30.0	5.0
150	14.9	16.9	24.7	39.7	41.7	21.3	24.3	18.9	28.2	5.0
200	8.8	10.8	29.0	37.8	39.8	18.8	21.8	18.0	27.0	5.0
250	3.5	5.5	32.8	36.3	38.3	16.8	19.8	17.3	26.0	5.0
350	—	—	39.8	34.1	36.1	13.9	16.9	16.3	—	—
400	—	—	43.0	33.3	35.3	12.8	15.8	15.9	—	—
500	—	—	48.9	31.8	33.8	10.8	13.8	15.2	—	—

Notes: Values are expressed in dB per 100m (328 ft) length. Values above 250 MHz are for informational purposes only.

**PHYSICAL DATA**

	CMR (NON-PLENUM)	CMP (PLENUM)
Nominal Cable Diameter (in)	0.220	0.205
Nominal Cable Weight (lbs/1000ft)	28	28
Minimum Bend Radius (in)	1.0	1.0
Maximum Pulling Force (lbs)	32	32
Temperature Rating (°C)		
Installation:	0 to +60	0 to +60
Operation:	-20 to +75	-20 to +75

**ELECTRICAL CHARACTERISTICS**

DC Resistance (max) Ohms/100m (328ft) @ 20 °C	9.38
DC Resistance Unbalance (max) Individual Pair %	4.0
Delay Skew (max) ns/100m	45
Nom. Velocity of Propagation % Speed of Light	CMP: 70 CMR: 68
Characteristic Impedance	Ohms
Frequency (f):	1-250 MHz 100 ± 15

Data subject to change.

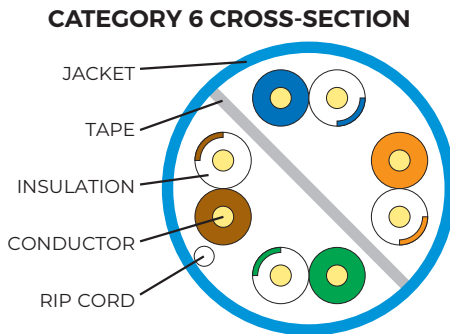

Designed to Meet NFPA 262 and CSA FT6 Steiner Tunnel Fire Tests for Plenum Applications

Underwriters Laboratories Inc.



# Category 5e Cable

Enhanced Transmission Throughput

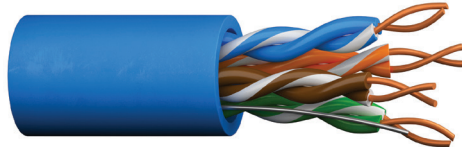

### PART NUMBERS

JACKET COLOR	PULL-PAC® II		SPOOL-PAC®	
	CMR (NON-PLENUM)	CMP (PLENUM)	CMR (NON-PLENUM)	CMP (PLENUM)
Blue	CR5.30.07	CP5.30.07	CR5.A3.07	CP5.A3.07
White	CR5.30.02	CP5.30.02	CR5.A3.02	CP5.A3.02
Gray	CR5.30.10	CP5.30.10	CR5.A3.10	CP5.A3.10
Green	CR5.30.06	CP5.30.06	CR5.A3.06	CP5.A3.06
Yellow	CR5.30.05	CP5.30.05	CR5.A3.05	CP5.A3.05
Red	CR5.30.03	CP5.30.03	CR5.A3.03	CP5.A3.03

### ELECTRICAL PERFORMANCE

FREQUENCY MHZ	PSACR (MIN)	ACR (MIN)	ATTENUATION (MAX)	PSNEXT (MIN)	NEXT (MIN)	PSELFEXT (MIN)	ELFEXT (MIN)	RETURN LOSS (MIN)
1	60.3	63.3	2.0	62.3	65.3	60.8	63.8	20.0
4	49.2	52.2	4.1	53.3	56.3	48.7	51.7	23.0
10	40.8	43.8	6.5	47.3	50.3	40.8	43.8	25.0
16	36.0	39.0	8.2	44.2	47.2	36.7	39.7	25.0
20	33.5	36.5	9.3	42.8	45.8	34.7	37.7	25.0
25	30.9	33.9	10.4	41.3	44.3	32.8	35.8	24.3
31.25	28.2	31.2	11.7	39.9	42.9	30.9	33.9	23.6
62.5	18.4	21.4	17.0	35.4	38.4	24.8	27.8	21.5
100	10.3	13.3	22.0	32.3	35.3	20.8	23.8	20.1
155	1.4	4.4	28.1	29.4	32.4	16.9	19.9	—
200	—	—	32.4	27.8	30.8	14.7	17.7	—
250	—	—	36.9	26.3	29.3	12.8	15.8	—
350	—	—	44.9	24.1	27.1	9.9	12.9	—

Notes: Values are expressed in dB per 100m (328 ft.) length. Values above 250 MHz are for informational purposes only.

### PHYSICAL DATA

	CMR (NON-PLENUM)	CMP (PLENUM)
Nominal Cable Diameter (in)	0.200	0.180
Nominal Cable Weight (lbs/1000ft)	21	19
Minimum Bend Radius (in)	1.0	1.0
Maximum Pulling Force (lbs)	25	25
Temperature Rating (°C)		
Installation:	0 to +60	0 to +60
Operation:	-10 to +60	-10 to +60

### ELECTRICAL CHARACTERISTICS

DC Resistance (max) Ohms/100m (328ft) @ 20 °C	9.38
DC Resistance Unbalance (max) Individual Pair %	4.0
Delay Skew (max) ns/100m	45
Nom. Velocity of Propagation % Speed of Light	CMP: 72 CMR: 70
Characteristic Impedance	Ohms
Frequency (f): 1-100 MHz	100 ± 15

Data subject to change.

### Product Construction:

#### Conductors:

- 24 AWG solid bare annealed copper

#### Insulation:

- Non-Plenum: Polyolefin
- Plenum: Fluoropolymer

#### Rip Cord:

- Applied longitudinally under jacket

#### Jacket:

- Non-Plenum: flame-retardant PVC
- Plenum: low-smoke, flame-retardant PVC
- TRU-Mark® print legend contains footage markings from 1000' to 0'

### Applications:

- IEEE 802.3: 1000 BASE-T (Gigabit Ethernet), 100 BASE-TX, 10 BASE-T
- 52/155 Mp/s ATM
- ANSI X3.263: 100 Mb/s
- 4/16 Mp/s token ring

### Compliances:

- ANSI/TIA 568 B.2 (Category 5e)
- ICEA S-90-661 (Category 5e)
- Type CMR (UL 1666) for Non-Plenum
- NEC/CEC Type CMP (NFPA 262 and CSA FT6 Steiner Tunnel Fire Tests for Plenum Applications)
- UL 444
- RoHS Compliant Directive 2011/65/EU
- Third-party verified for guaranteed performance

### Packaging:

- 1000' Pull-Pac® II
- 1000' Spool-Pac®

### CATEGORY 5e CROSS-SECTION

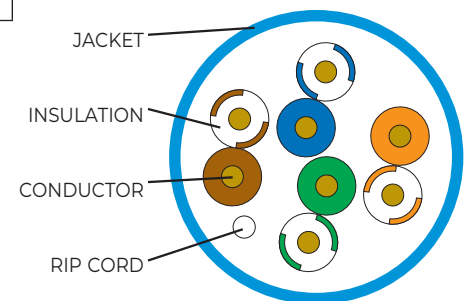

Designed to Meet  
NFPA 262 and CSA FT6  
Steiner Tunnel Fire Tests  
for Plenum Applications  
Underwriters Laboratories Inc.



# Coaxial Cable

8

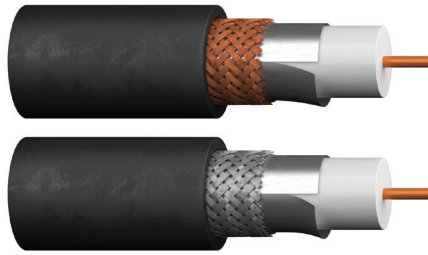

To meet the needs of today's sophisticated, high-speed, wide bandwidth electronics over long distances, with minimum signal loss or degradation, Prysmian CAROL® Brand offers a wide range of coaxial and twinaxial designs in both unbalanced arrays and precision-balanced pairs. This offers the system designer a wide choice of cost-effective products that reflect the most recent changes in the standards set by UL, CSA and/or the FCC.

Included in this section are recommended CAROL Brand coaxial products for the CATV market. However, these constructions may differ in certain parts of the country.

Unlike other products in the electronic market, coaxial cable does not have one accepted standard construction.

Prysmian recommends, in order to avoid installing an unacceptable coaxial cable for the CATV application in your area, the local CATV company should be consulted.

Prysmian's CAROL Brand product mix encompasses standard RG/U-type coaxial constructions in the more popular 50, 75 and 93 ohm designs and miniature coaxial products for smaller high-speed applications.

The twinaxial products meet or exceed the stringent demands of today's precision-balanced pair systems. The minimization of capacitance unbalance is a necessary requirement for long distance data transmission.

Section	Page
RG 6/U Type	112-116
RG 8/U Type	117
RG 11/U Type	118-120
RG 58/U Type	121
RG 59/U Type	122-126
RG 62/U Type	127
RG 174/U Type	128
RG 213/U Type	129
Twinaxial Cables	130

# RG 6/U Type

**Product Construction:**

**Conductors:**

- Copper per ASTM B3
- Copper-clad steel per ASTM B869

**Insulation/Core:**

- Foam polyethylene (PE)

**Shield:**

- Bare copper or aluminum braid
- Flexfoil® shield

**Jacket:**



- Premium PVC compound

**Packaging:**

- Please contact Customer Service for packaging and color options

**Applications:**

- Suitable for RF signal transmission
- MATV
- CATV
- CCTV†
- HDTV
- Digital video
- Drop cable
- FM broadcast

CATALOG NUMBER	AWG SIZE NOM. DCR	INSULATION O.D.		SHIELD COVERAGE NOM SHLD DCR	NOMINAL O.D.		NOMINAL CAPACITANCE		VELOCITY OF PROPAGATION, %	NOMINAL IMPEDANCE, Ω	NOMINAL ATTENUATION	
		in	mm		in	mm	pF/ft	pF/m			MHz	dB/100'
<b>C5761†</b> RG 6/U Type UL CL2, CM c(UL) CM, (UL) 	18 Ga. Solid Bare Copper 6.5 Ω/Mft.	Foam PE		100% Flexfoil® +95% Bare Copper Braid 2.6 Ω/Mft.	PVC		16.20	53.15	83	75	1	0.26
		0.180	4.57		0.275	6.98					10	0.81
<b>C5775</b> RG 6/U Type UL CL2, CATV, CM c(UL) CM, (UL) 	18 Ga. Solid Copper- Clad Steel 28.9 Ω/ Mft.	Foam PE		100% Flexfoil® Bonded +60% Aluminum Braid 9.0 Ω/Mft.	PVC		16.20	53.15	83	75	1	0.26
		0.180	4.57		0.276	7.01					10	0.81
<b>C5886</b> RG 6/U Type Riser UL CL2R, CATVR, CMR c(UL) CMR, c(UL) CM (UL) 	18 Ga. Solid Copper- Clad Steel 28.9 Ω/ Mft.	Foam PE		100% Flexfoil® Bonded +60% Aluminum Braid 9.0 Ω/Mft.	PVC		16.20	53.15	83	75	1	0.34
		0.180	4.57		0.276	7.01					10	1.05

Data subject to change.

# RG 6/U Type

**Product Construction:**

**Conductors:**

- Copper-clad steel per ASTM B869

**Insulation/Core:**

- Foam polyethylene (PE)

**Shield:**

- Tinned, bare copper or aluminum braid
- Flexfoil® shield

**Jacket:**



- Premium PVC compound or PE compound

**Packaging:**

- Please contact Customer Service for packaging and color options

**Applications:**

- CATV
- Direct burial

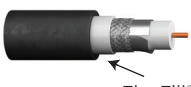
CATALOG NUMBER	AWG SIZE NOM. DCR	INSULATION O.D.		SHIELD COVERAGE NOM SHLD DCR	NOMINAL O.D.		NOMINAL CAPACITANCE		VELOCITY OF PROPAGATION, %	NOMINAL IMPEDANCE, Ω	NOMINAL ATTENUATION	
		in	mm		in	mm	pF/ft	pF/m			MHz	dB/100'
<b>C5785</b> <b>RG 6/U Type</b> <b>Quad-Shield</b> <b>UL CL2, CATV, CM</b> <b>c(UL) CM</b> 	18 Ga. Solid Copper-Clad Steel 28.9 Ω/Mft.	Foam PE		(2) 100% Flexfoil® 1st Bonded (1) 60% (2) 40% Aluminum Braids 3.7 Ω/Mft.	PVC		16.20	53.15	83	75	1	0.35
		0.180	4.57		0.298	7.57					10	0.65
<b>C5889</b> <b>RG 6/U Type Riser</b> <b>Quad-Shield</b> <b>UL CL2R, CATVR,</b> <b>CMR</b> <b>c(UL) CM</b> 	18 Ga. Solid Copper-Clad Steel 28.9 Ω/Mft.	Foam PE		(2) 100% Flexfoil® 1st Bonded (1) 60% (2) 40% Aluminum Braids 3.7 Ω/Mft.	PVC		16.20	53.15	83	75	1	0.26
		0.180	4.57		0.298	7.57					10	0.81
<b>C5777</b> <b>RG 6/U Type</b> <b>UL CL2, CATV, CM</b> <b>c(UL) CM</b> 	18 Ga. Solid Copper-Clad Steel 28.9 Ω/Mft.	Foam PE		100% Flexfoil® Bonded +61% Tinned Copper Braid 6.5 Ω/Mft.	PVC		16.20	53.15	83	75	1	0.26
		0.180	4.57		0.271	6.88					10	0.81
<b>C5804</b> <b>RG 6/U Type</b> <b>MoistureGuard™</b> <b>Direct Burial,</b> <b>Flooded</b> 	18 Ga. Solid Copper-Clad Steel 28.9 Ω/Mft.	Foam PE		100% Flexfoil® Bonded +60% Aluminum Braid w/water block 9.0 Ω/Mft.	Black PE		16.20	53.15	83	75	1	0.26
		0.180	4.57		0.270	6.86					10	0.81

Data subject to change.

# RG 6/U Type

**Product Construction:**

**Conductors:**

- Copper per ASTM B3
- Copper-clad steel per ASTM B869

**Insulation/Core:**

- Foam polyethylene (PE)

**Shield:**

- Aluminum braid
- Flexfoil® shield

**Jacket:**

- Premium PVC compound

**Packaging:**

- Please contact Customer Service for packaging and color options

**Applications:**

- LAN cable
- CATV
- Direct broadcast satellite

CATALOG NUMBER	AWG SIZE NOM. DCR	INSULATION O.D.		SHIELD COVERAGE NOM SHLD DCR	NOMINAL O.D.		NOMINAL CAPACITANCE		VELOCITY OF PROPAGATION, %	NOMINAL IMPEDANCE, Ω	NOMINAL ATTENUATION	
		in	mm		in	mm	pF/ft	pF/m			MHz	dB/100'
<b>C5822</b> <b>RG 6/U Dual-Type DBS</b> <b>UL CL2, CATV, CM c(UL) CM</b> 	18 Ga. Solid Copper-Clad Steel 28.9 Ω/Mft.	Foam PE		100% Flexfoil® Bonded +60% Aluminum Braid 9.0 Ω/Mft.	PVC		16.20	53.15	83	75	1	0.26
		0.180	4.57		0.270	6.86					10	0.81
					x	x					50	1.46
					0.595	15.11					100	2.05
											200	2.83
											500	4.53
											1000	6.59
											1450	8.10
											1800	8.80
											2200	10.10
				3000	11.79							

Data subject to change.



# RG 6/U Type

**Product Construction:**

**Conductors:**

- Copper per ASTM B3 or copper-clad steel per ASTM B869
- Twisted pair color code: black and red

**Insulation/Core:**

- Foam polyethylene (PE)
- Foam fluoropolymer (FEP)

**Shield:**

- Bare copper, tinned copper, or aluminum braid
- Flexfoil® shield

**Jacket:**





- Premium-grade PVC compound
- Flexguard® PVC compound

**Packaging:**

- Please contact Customer Service for packaging and color options

**Applications:**

- Suitable for RF signal transmission
- CATV
- CCTV†
- DBS
- Drop cable
- FM broadcast
- HDTV
- Digital video

CATALOG NUMBER	AWG SIZE NOM. DCR	INSULATION O.D.		SHIELD COVERAGE NOM SHLD DCR	NOMINAL O.D.		NOMINAL CAPACITANCE		VELOCITY OF PROPAGATION, %	NOMINAL IMPEDANCE, Ω	NOMINAL ATTENUATION	
		in	mm		in	mm	pF/ft	pF/m			MHz	dB/100'
<b>C3521</b> RG 6/U Type Plenum UL CL2P, CMP c(UL) CMP 	18 Ga. Solid Bare Copper 6.5 Ω/Mft.	Fluoropolymer		Flexfoil® Bonded +95% Tinned Copper Braid 2.3 Ω/Mft.	Flexguard® PVC		16.00	52.50	83	75	1	0.30
		0.170	4.32		0.227	5.77					10	0.66
<b>C3524</b> RG 6/U Type Plenum UL CL2P, CMP c(UL) CMP, CATV 	18 Ga. Solid Copper-Clad Steel 28.6 Ω/Mft.	Fluoropolymer		Flexfoil® Bonded +80% Aluminum Braid 9.0 Ω/Mft.	Flexguard® PVC		16.00	52.50	83	75	1	0.30
		0.170	4.32		0.232	5.89					10	0.66
<b>C3525</b> RG 6/U Type Quad Shield Plenum UL CL2P, CMP c(UL) CMP 	18 Ga. Solid Copper-Clad Steel 28.6 Ω/Mft.	Fluoropolymer		(2) 100% Flexfoil® (1) 60% (2) 40% Aluminum Braids 5.3 Ω/Mft.	Flexguard® PVC		16.20	52.50	83	75	1	0.30
		0.170	4.32		0.264	6.70					10	0.66
<b>C8029†</b> RG 6/U Type +18 AWG Unshielded Pair UL CL2, CM c(UL) CM 	18 Ga. Solid Bare Copper Coax 18 AWG (7/26) Unshielded Pair	Foam PE		100% Flexfoil® 95% Bare Copper Braid 1.9 Ω/Mft. Unshielded Pair	PVC		17.00	53.15	83	75	1	0.26
		0.180	4.57		0.275	6.99					10	0.81
		Premium PVC			x	x					50	1.46
		0.010	0.25		0.496	12.59					100	2.05
											200	2.83
											500	4.53
											1000	6.59

Data subject to change.

# RG 6/U Type

**Product Construction:**

**Conductors:**

- Copper per ASTM B3

**Insulation/Core:**

- Foam polyethylene (PE)
- Foam fluoropolymer (FEP)

**Shield:**

- Tinned copper braid
- Flexfoil® shield
- Bare copper braid

**Jacket:**



- Premium-grade PVC compound
- Flexguard® PVC compound or PVDF

**Packaging:**

- Please contact Customer Service for packaging and color options

**Applications:**

- Broadcast grade headend
- Serial Digital Interface (SDI)
- CATV
- DBS
- Drop cable
- HDTV
- CCTV†
- Digital video

CATALOG NUMBER	AWG SIZE NOM. DCR	INSULATION O.D.		SHIELD COVERAGE NOM SHLD DCR	NOMINAL O.D.		NOMINAL CAPACITANCE		VELOCITY OF PROPAGATION, %	NOMINAL IMPEDANCE, Ω	NOMINAL ATTENUATION	
		in	mm		in	mm	pF/ft	pF/m			MHz	dB/100'
<b>395011</b> ETL CMR c(ETL) CMR ETL CL2R c(ETL) CL2R 	18 Ga. Solid Bare Copper 6.5 Ω/ Mft.	Foam PE		Dual Foil + 95% Tinned Copper Braid Shield 2.8 Ω/Mft.	Flame-Retardant PVC		16.00	53.10	83	75	1	0.24
		0.180	4.57		0.275	6.91					3.6	0.45
<b>495035†</b> UL CMP c(UL) CMP 75°C 	18 Ga. Solid Bare Copper 6.7 Ω/ Mft.	Fluoropolymer		95% Bare Copper Braid 2.0 Ω/Mft.	Flexguard® PVC		16.00	52.50	83	75	1	0.21
		0.170	4.32		0.277	5.77					10	0.59
											50	1.38
											100	2.24
											200	3.13
											540	5.50
											1000	8.16
											1500	10.12
											2250	13.23
											3000	16.11

Data subject to change.

# RG 8/U Type

**Product Construction:**

**Conductors:**

- Copper per ASTM B3

**Insulation/Core:**

- Solid and foam polyethylene

**Shield:**

- Tinned or bare copper braid
- Flexfoil® shield

**Jacket:**



- Premium PVC compound

**Packaging:**

- Please contact Customer Service for packaging and color options

**Applications:**

- Suitable for RF signal transmission
- Broadcast

CATALOG NUMBER	AWG SIZE NOM. DCR	INSULATION O.D.		SHIELD COVERAGE NOM SHLD DCR	NOMINAL O.D.		NOMINAL CAPACITANCE		VELOCITY OF PROPAGATION, %	NOMINAL IMPEDANCE, Ω	NOMINAL ATTENUATION	
		in	mm		in	mm	pF/ft	pF/m			MHz	dB/100'
<b>C1154</b> RG 8/U Type JAN-C-17A TYPE 	13 Ga. (7/21) Bare Copper 1.9 Ω/ Mft.	Solid PE		95% Bare Copper Braid 1.2 Ω/Mft.	PVC		30.80 101.05	66	50	1 10 50 100 200 500 1000	0.20 0.58 1.38 2.15 3.08 5.45 8.60	
		0.285	7.24		0.405	10.29						
<b>C1198</b> RG 8/U Type 	11 Ga. (19/24) Bare Copper 1.9 Ω/ Mft.	Foam PE		95% Bare Copper Braid 1.1 Ω/Mft.	PVC		24.00 78.74	78	52	1 10 50 100 200 500 1000	0.30 0.75 1.30 1.80 3.00 4.50 6.00	
		0.285	7.24		0.405	10.29						
<b>C1180</b> RG 8/U Type Air Core 	9½ Ga. Solid Bare Copper 0.90 Ω/ Mft.	Foam PE		100% Flexfoil® Bonded +88% Tinned Copper Braid 1.8 Ω/Mft.	PVC		24.60 80.71	84	50	1 10 50 100 200 500 1000	0.13 0.40 0.90 1.30 1.80 3.00 4.50	
		0.285	7.24		0.405	10.29						

Data subject to change.

# RG 11/U Type

**Product Construction:**

**Conductors:**

- Copper-clad steel per ASTM B869

**Insulation/Core:**

- Foam polyethylene (PE)

**Shield:**

- Tinned, copper braid
- Flexfoil® shield

**Jacket:**

- Premium PVC compound

**Packaging:**

- Please contact Customer Service for packaging and color options

**Applications:**

- Suitable for RF signal transmission
- Broadcast digital video
- MATV
- CATV
- Drop cable
- Outdoor use

CATALOG NUMBER	AWG SIZE NOM. DCR	INSULATION O.D.		SHIELD COVERAGE NOM SHLD DCR	NOMINAL O.D.		NOMINAL CAPACITANCE		VELOCITY OF PROPAGATION, %	NOMINAL IMPEDANCE, Ω	NOMINAL ATTENUATION												
		in	mm		in	mm	pF/ft	pF/m			MHz	dB/100'											
<b>C5029</b> <b>RG 11/U Type</b> <b>UL CL2, CM</b> <b>c(UL) CM, CATV</b> 	14 Ga. Solid Copper-Clad Steel 11.4 Ω/Mft.	Foam PE		100% Flexfoil® Bonded +61% Tinned Copper Braid 3.0 Ω/Mft.	PVC		16.20	53.15	83	75	1	0.30											
		0.280	7.11		0.400	10.16					10	0.70	50	0.90	100	1.30	200	1.90	500	3.00	1000	4.40	1450

Data subject to change.

# RG 11/U Type

**Product Construction:**

**Conductor:**

- Copper-clad steel per ASTM B3

**Insulation/Core:**

- Foam polyethylene (PE)

**Shield:**

- Aluminum braid
- Flexfoil® shield

**Jacket:**

- Premium PVC compound

**Packaging:**

- Please contact Customer Service for packaging and color options

**Applications:**

- Suitable for RF signal transmission
- Broadcast digital video
- MATV
- CATV
- Drop cable

CATALOG NUMBER	AWG SIZE NOM. DCR	INSULATION O.D.		SHIELD COVERAGE NOM SHLD DCR	NOMINAL O.D.		NOMINAL CAPACITANCE		VELOCITY OF PROPAGATION, %	NOMINAL IMPEDANCE, Ω	NOMINAL ATTENUATION	
		in	mm		in	mm	pF/ft	pF/m			MHz	dB/100'
<b>C5039</b> <b>RG 11/U Type</b> <b>UL CL2, CATV, CM</b> <b>CSA CMG, c(UL) CM</b> 	14 Ga. Solid Copper- Clad Steel 11.4 Ω/Mft.	Foam PE		100% Flexfoil® Bonded +60% Aluminum Braid 4.6 Ω/Mft.	PVC		16.20	53.15	85	75	1	0.30
		0.280	7.11		0.400	10.16					10	0.70
											50	0.90
											100	1.30
											200	1.90
											500	3.00
											1000	4.40
											1450	5.30
											1800	5.90
											2200	6.53
				3000	7.62							

Data subject to change.

# RG 11/U Type Serial Digital Interface (SDI) Precision Cable

Extended-Distance, 75 Ohm High-End Coaxial Cables for Exacting Video, Analog & Digital Applications

**Product Construction:**

**Conductor:**

- Copper per ASTM B3

**Insulation/Core:**

- Foam polyethylene (PE)

**Shield:**

- Bare copper

**Jacket:**

- Premium PVC compound

**Packaging:**

- Please contact Customer Service for packaging and color options

**Applications:**

- Suitable for RF signal transmission
- Broadcast-grade Serial Digital Interface (SDI)
- Analog/digital video
- MATV
- CATV
- CCTV†
- Drop cable
- HDTV

CATALOG NUMBER	AWG SIZE NOM. DCR	O.D.		SHIELD COVERAGE NOM SHLD DCR	NOMINAL O.D.		NOMINAL CAPACITANCE		VELOCITY OF PROPAGATION, %	NOMINAL IMPEDANCE, Ω	NOMINAL ATTENUATION										
		in	mm		in	mm	pF/ft	pF/m			MHz	dB/100'									
<b>395058†</b> RG 11/U Type UL CM, CL2 c(UL) CMG 	14 Ga. Solid Bare Copper 2.6 Ω/Mft.	Foam PE		95% Bare Copper Braid 1.2 Ω/Mft.	Flame-Retardant PVC		16.20	52.50	83	75	1	0.17									
		0.280	7.11		0.400	10.16					10	0.35	50	0.90	100	1.30	200	1.90	400	2.90	540

Data subject to change.

# RG 58/U Type

**Product Construction:**

**Conductors:**

- Copper per ASTM B3
- Tinned copper per ASTM B33

**Insulation/Core:**

- Solid and foam polyethylene (PE)
- Foam fluoropolymer (FEP)

**Shield:**

- Tinned copper braid

**Jacket:**





- Premium PVC compound

**Packaging:**

- Please contact Customer Service for packaging and color options

**Applications:**

- Suitable for RF signal transmission
- Broadcast
- LAN & data transmission

CATALOG NUMBER	AWG SIZE NOM. DCR	INSULATION O.D.		SHIELD COVERAGE NOM SHLD DCR	NOMINAL O.D.		NOMINAL CAPACITANCE		VELOCITY OF PROPAGATION, %	NOMINAL IMPEDANCE, Ω	NOMINAL ATTENUATION	
		in	mm		in	mm	pF/ft	pF/m			MHz	dB/100'
<b>C1155</b> RG 58 C/U Type MIL-C-17C Type 	20 Ga. (19/0071) Tinned Copper 10.8 Ω/Mft.	Solid PE		95% Tinned Copper Braid 4.3 Ω/Mft.	Non- Contaminating PVC		30.80	101.05	66	50	1	0.42
		0.116	2.95		0.195	4.95					10	1.50
<b>C1166</b> RG 58/U Type JAN-C-17A Type Ⓢ 1354 	20 Ga. Solid Bare Copper 10.1 Ω/Mft.	Solid PE		95% Tinned Copper Braid 4.3 Ω/Mft.	PVC		30.00	98.43	66	50	1	0.40
		0.116	2.95		0.195	4.95					10	1.20
<b>C1188</b> RG 58 A/U Type UL CL2, CM CSA CMG Ⓢ 1354 	20 Ga. (19/32) Tinned Copper 9.5 Ω/Mft.	Foam PE		95% Tinned Copper Braid 4.3 Ω/Mft.	PVC		26.00	85.31	78	50	1	0.45
		0.114	2.90		0.195	4.95					10	1.42
<b>C3519</b> RG 58/U Type Plenum UL CL2P, CMP c(UL) CMP 	19 Ga. Solid Bare Copper 8.1 Ω/Mft.	Fluoropolymer		95% Tinned Copper Braid 5.5 Ω/Mft.	Flexguard® PVC		25.00	82.00	80	53	1	0.40
		0.102	2.59		0.157	3.99					10	1.30
<b>C1178A</b> RG 58A/U Type JAN-C-17A Type Ⓢ 1354 	20 Ga. (19/0071) Tinner Copper 10.8 Ω/Mft	Solid PE		95% Tinned Copper Braid 4.3 Ω/Mft.	Black PVC		30.00	98.43	66	50	1	0.42
		0.116	2.95		0.195	4.95					10	1.50

Data subject to change.

# RG 59/U Type

**Product Construction:**

**Conductors:**

- Copper per ASTM B3
- Copper-clad steel per ASTM B869
- Twisted pair color code: black and red

**Insulation/Core:**

- Solid and cellular polyethylene (PE)

**Shield:**

- Bare copper braid

**Jacket:**



- Premium PVC compound or PE compound

**Packaging:**

- Please contact Customer Service for packaging and color options

**Applications:**

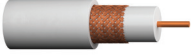
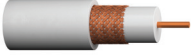
- Suitable for RF signal transmission
- CATV
- MATV
- CCTV†
- Local Area Network
- Digital video
- Monitor/VDT display

CATALOG NUMBER	AWG SIZE NOM. DCR	INSULATION O.D.		SHIELD COVERAGE NOM SHLD DCR	NOMINAL O.D.		NOMINAL CAPACITANCE		VELOCITY OF PROPAGATION, %	NOMINAL IMPEDANCE, Ω	NOMINAL ATTENUATION	
		in	mm		in	mm	pF/ft	pF/m			MHz	dB/100'
<b>C1102</b> <b>RG 59/U Type</b> 	20 Ga. Solid Copper-Clad Steel 45.9 Ω/Mft.	Foam PE		95% Bare Copper Braid 3.5 Ω/Mft.	Black PE		17.30	56.76	82	75	1	0.26
		0.146	3.71		0.242	6.15					10	0.82
											50	1.80
											100	2.60
											200	3.70
											500	6.00
											1000	8.80
											1450	10.60
											1800	11.81
											2200	13.05
											3000	15.24
<b>C1104</b> <b>RG 59/U Type</b> 	22 Ga. Solid Copper-Clad Steel 73.4 Ω/Mft.	Solid PE		95% Bare Copper Braid 2.6 Ω/Mft.	PVC		20.50	67.26	66	73	1	0.41
		0.146	3.71		0.242	6.15					10	0.99
											50	2.38
											100	3.49
											200	5.09
											500	8.43
											1000	13.03
											1450	15.69
											1800	17.48
											2200	19.33
											3000	22.57
<b>C1103†</b> <b>RG 59/U Type</b> <b>UL CL2, CATV, CM</b> <b>CSA CMG</b> 	22 Ga. (7/30) Bare Copper 14.8 Ω/Mft.	Foam PE		95% Bare Copper Braid 2.6 Ω/Mft.	PVC		16.20	53.15	78	77	1	0.26
		0.146	3.71		0.242	6.15					10	0.91
											50	2.09
											100	3.00
											200	4.33
											500	7.03
											1000	10.64
											1450	12.81
											1800	14.28
											2200	15.78
											3000	18.43
<b>C1142†</b> <b>RG 59/U Type</b> <b>UL CL2, CATV, CM</b> <b>CSA CMG</b> 	20 Ga. Solid Bare Copper 10.1 Ω/Mft.	Foam PE		95% Bare Copper Braid 2.6 Ω/Mft.	PVC		16.20	53.15	83	75	1	0.25
		0.146	3.71		0.236	5.99					10	0.78
											50	1.97
											100	2.79
											200	3.97
											500	6.35
											1000	9.15
											1450	11.02
											1800	12.28
											2200	13.57
											3000	15.85

Data subject to change.



# RG 59/U Type

**Product Construction:**

**Conductors:**

- Copper per ASTM B3
- Copper-clad steel per ASTM B869
- Twisted pair color code: black and red

**Insulation/Core:**

- Solid polyethylene (PE), Fluoropolymer (FEP) and polyvinylchloride (PVC)

**Shield:**

- Tinned, bare copper or aluminum braid
- Flexfoil® shield

**Jacket:**



- Premium PVC compound

**Packaging:**

- Please contact Customer Service for packaging and color options

**Applications:**

- Suitable for RF signal transmission
- MATV
- CATV
- CCTV†
- Local Area Network
- Monitor/VDT display
- Analog video
- Digital video

CATALOG NUMBER	AWG SIZE NOM. DCR	INSULATION O.D.		SHIELD COVERAGE NOM SHLD DCR	NOMINAL O.D.		NOMINAL CAPACITANCE		VELOCITY OF PROPAGATION, %	NOMINAL IMPEDANCE, Ω	NOMINAL ATTENUATION	
		in	mm		in	mm	pF/ft	pF/m			MHz	dB/100'
<b>C1106</b> <b>RG 59B/U Type</b> <b>MIL-C-17D Type</b> 	23 Ga. Solid Copper-Clad Steel 68.5 Ω/Mft.	Solid PE		95% Bare Copper Braid 2.6 Ω/Mft.	Non-Contaminating PVC		20.50	67.26	66	75	1	
		0.146	3.71		0.240	6.10					10	0.44
<b>C8030†</b> <b>RG 59/U Type</b> <b>+18 AWG</b> <b>Unshielded Pair</b> <b>UL CMP c(UL) CMP</b> 	20 AWG Solid BC Coax 18 AWG (7/26) Unshielded Pair	FEP		95% Bare Copper Braid	Flexguard® PVC		16.30	53.48	83	75	1	
		0.135	3.43		0.200 X	5.08 X					10	0.78
		PVC		Unshielded Pair	0.383	9.73					50	1.90
		0.006	0.15		100	2.80						
											200	4.10
											500	6.82
											1000	9.64

Data subject to change.

# RG 59/U Type

**Product Construction:**

**Conductors:**

- Copper-clad steel per ASTM B869

**Insulation/Core:**

- Foam polyethylene (PE)

**Shield:**

- Aluminum braid
- Flexfoil® shield

**Jacket:**



- Premium PVC compound

**Packaging:**

- Please contact Customer Service for packaging and color options

**Applications:**

- Suitable for RF signal transmission
- CATV
- MATV
- Drop cable
- Local Area Network
- Monitor/VDT display

CATALOG NUMBER	AWG SIZE NOM. DCR	INSULATION O.D.		SHIELD COVERAGE NOM SHLD DCR	NOMINAL O.D.		NOMINAL CAPACITANCE		VELOCITY OF PROPAGATION, %	NOMINAL IMPEDANCE, Ω	NOMINAL ATTENUATION	
		in	mm		in	mm	pF/ft	pF/m			MHz	dB/100'
<b>C5770</b> RG 59/U Type UL CL2, CM CSA CMG 1354 	22 Ga. Solid Copper- Clad Steel 73.4 Ω/ Mft.	Foam PE		100% Flexfoil® Bonded + 40% Aluminum Braid 11.0 Ω/Mft.	PVC		16.00	52.50	78	80	1	0.50
		0.144	3.66		0.236	5.99					10	1.00
											50	2.30
											100	3.30
											200	4.10
											500	6.50
											1000	9.40
											1450	11.32
											1800	12.61
											2200	13.94
				3000	16.28							
<b>C5780</b> RG 59/U Type MATV UL CL2, CM CSA CMG 1354 	20 Ga. Solid Copper- Clad Steel 45.9 Ω/ Mft.	Foam PE		100% Flexfoil® Bonded + 40% Aluminum Braid 11.0 Ω/Mft.	PVC		16.20	53.15	83	75	1	0.60
		0.144	3.66		0.236	5.99					10	1.20
											50	1.95
											100	2.70
											200	3.70
											500	5.70
											1000	8.12
											1450	9.78
											1800	10.89
											2200	12.04
				3000	14.06							

Data subject to change.

# RG 59/U Type

**Product Construction:**

**Conductors:**

- Copper per ASTM B3
- Twisted pair color code: black and red

**Insulation/Core:**

- Foam polyethylene (PE), Fluoropolymer (FEP) and polyvinylchloride (PVC)

**Shield:**

- Bare copper braid
- Flexfoil® shield

**Jacket:**



- Premium PVC compound

**Packaging:**

- Please contact Customer Service for packaging and color options

**Applications:**

- Suitable for RF signal transmission
- MATV
- CCTV†
- Local Area Network
- Monitor/VDT display

CATALOG NUMBER	AWG SIZE NOM. DCR	INSULATION O.D.		SHIELD COVERAGE NOM SHLD DCR	NOMINAL O.D.		NOMINAL CAPACITANCE		VELOCITY OF PROPAGATION, %	NOMINAL IMPEDANCE, Ω	NOMINAL ATTENUATION	
		in	mm		in	mm	pF/ft	pF/m			MHz	dB/100'
<b>C8027†</b> <b>RG 59/U Type</b> <b>+18 AWG</b> <b>Shielded Pair</b> <b>UL CL2, CM</b> <b>c(UL) CM</b> 	22 AWG (7/30) Bare Copper Coax 18 AWG (16/30) Shielded Pair	Foam PE		95% Bare Copper Braid 125% Flexfoil® Al/PP Shielded	PVC		17.00	55.78	78	77	1	0.26
		0.144	3.66		0.242	6.15					10	0.91
		Premium PVC			X	X					50	2.09
		0.046	1.17		0.470	11.94					100	3.00
<b>C8028†</b> <b>RG 59/U Type</b> <b>+18 AWG</b> <b>Unshielded Pair</b> <b>UL CL2, CM</b> <b>c(UL) CM</b> 	20 AWG Solid Bare Copper Coax 18 AWG (7/26) Unshielded Pair	Foam PE		95% Bare Copper Braid Unshielded Pair	PVC		16.20	53.15	78	75	1	0.25
		0.144	3.66		0.238	6.05					10	0.78
		Premium PVC			X	X					50	1.97
		0.066	1.68		0.440	11.18					100	2.70
											500	6.35
											1000	9.15

Data subject to change.

# RG 59/U Serial Digital Interface Cable

75 Ohm High-End Coaxial Cables for Video, Analog & Digital Applications

**Product Construction:**

**Conductors:**

- Copper per ASTM B3

**Insulation/Core:**

- Foam fluoropolymer (FEP)

**Shield:**

- Bare copper braid

**Jacket:**

- Premium PVC compound

**Packaging:**

- Please contact Customer Service for packaging and color options

**Applications:**

- Suitable for RF signal transmission
- Broadcast-grade
- MATV
- CATV
- Precision video-analog/digital
- Serial digital interface cable (SDI)

CATALOG NUMBER	AWG SIZE NOM. DCR	INSULATION O.D.		SHIELD COVERAGE NOM SHLD DCR	NOMINAL O.D.		NOMINAL CAPACITANCE		VELOCITY OF PROPAGATION, %	NOMINAL IMPEDANCE, Ω	NOMINAL ATTENUATION		
		in	mm		in	mm	pF/ft	pF/m			MHz	dB/100'	
<b>495028†</b> <b>RG 59/U Type</b> <b>UL CMP</b> <b>c(UL) CMP</b> 	20 Ga. Solid Bare Copper 10.5 Ω/Mft.	Fluoropolymer		95% Bare Copper Braid Shield 2.7 Ω/Mft.	Flexguard® PVC		16.00	52.50	84	75	1	0.24	
		0.139	3.43		0.196	4.97					10	1.41	50

Data subject to change.

# RG 62/U Type

**Product Construction:**

**Conductors:**

- Copper-clad steel per ASTM B869

**Insulation/Core:**

- Foam polyethylene (PE)

**Shield:**

- Bare copper braid

**Jacket:**

- Premium PVC compound

**Packaging:**

- Please contact Customer Service for packaging and color options

**Applications:**

- Suitable for RF signal transmission
- Computer/networks

CATALOG NUMBER	AWG SIZE NOM. DCR	INSULATION O.D.		SHIELD COVERAGE NOM SHLD DCR	NOMINAL O.D.		NOMINAL CAPACITANCE		VELOCITY OF PROPAGATION, %	NOMINAL IMPEDANCE, Ω	NOMINAL ATTENUATION	
		in	mm		in	mm	pF/ft	pF/m			MHz	dB/100'
<b>C1164</b> <b>RG 62/U Type</b> <b>Computer Cable</b> <b>JAN-C-17A Type</b> <b>UL CL2, CM</b> <b>CSA CMG</b> 	22 Ga. Solid Copper- Clad Steel 73.4 Ω/Mft.	Foam PE		95% Bare Copper Braid 2.6 Ω/Mft.	PVC		13.60	44.62	84	93	1	0.38
		0.146	3.66		10	0.85						
					50	1.90						
					100	2.70						
					200	3.80						
0.242	6.15	500	5.90									
		1000	8.70									

Data subject to change.

# RG 174/U Type

**Product Construction:**

**Conductors:**

- Copper-clad steel per ASTM B869

**Insulation/Core:**

- Solid polyethylene (PE)

**Shield:**

- Tinned copper braid

**Jacket:**

- Premium PVC compound

**Packaging:**

- Please contact Customer Service for packaging and color options

**Applications:**

- Suitable for RF signal transmission

CATALOG NUMBER	AWG SIZE NOM. DCR	INSULATION O.D.		SHIELD COVERAGE NOM SHLD DCR	NOMINAL O.D.		NOMINAL CAPACITANCE		VELOCITY OF PROPAGATION, %	NOMINAL IMPEDANCE, Ω	NOMINAL ATTENUATION				
		in	mm		in	mm	pF/ft	pF/m			MHz	dB/100'			
<b>C1156</b> <b>RG 174/U Type</b> 	26 Ga. (7/34) Copper-Clad Steel 97.0 Ω/Mft.	Solid PE		88% Tinned Copper Braid 10.3 Ω/Mft.	PVC		30.00	98.43	66	50	1	1.90			
		0.059	1.50		0.103	2.62					10	3.30	50	5.80	100

Data subject to change.

# RG 213/U Type

**Product Construction:**

**Conductors:**

- Copper per ASTM B3

**Insulation/Core:**

- Solid polyethylene (PE)

**Shield:**

- Bare copper braid

**Jacket:**

- Premium non-contaminating black PVC

**Packaging:**

- Please contact Customer Service for packaging and color options

**Applications:**

- Suitable for RF signal transmission

CATALOG NUMBER	AWG SIZE NOM. DCR	INSULATION MATERIAL		SHIELD COVERAGE NOM SHLD DCR	NOMINAL O.D.		NOMINAL CAPACITANCE		VELOCITY OF PROPAGATION, %	NOMINAL IMPEDANCE, Ω	NOMINAL ATTENUATION				
		in	mm		in	mm	pF/ft	pF/m			MHz	dB/100'			
<b>C1176A</b> <b>RG 213/U Type</b> <b>MIL-C-17G Type</b> 	13 Ga. (7/21) Bare Copper 1.7 Ω/Mft.	Solid PE		95% Bare Copper Braid 1.2 Ω/Mft.	PVC		30.80	101.05	66	50	1	0.18			
		0.285	7.24		0.405	10.29					10	0.62	50	1.50	100

Data subject to change.

# Twinaxial Cables

**Product Construction:**

**Conductors:**

- Tinned copper per ASTM B33

**Insulation/Core:**

- Solid polyethylene (PE)

**Shield:**

- Tinned copper braid
- Flexfoil® shield

**Jacket:**

- Premium PVC compound

**Packaging:**

- Please contact Customer Service for packaging and color options

**Applications:**

- Programmable Logic Controllers (PLC)
- Data transmission
- Broadcast
- Computer

CATALOG NUMBER	AWG SIZE NOM. DCR	INSULATION MATERIAL		SHIELD COVERAGE NOM SHLD DCR	NOMINAL O.D.		NOMINAL CAPACITANCE		VELOCITY OF PROPAGATION, %	NOMINAL IMPEDANCE, Ω	NOMINAL ATTENUATION	
		in	mm		in	mm	pF/ft	pF/m			MHz	dB/100'
<b>C8001</b> UL CL2, CM C(UL) CM 2464 60°C, 300V 	20 Ga. (7/28) Tinned Copper 9.5 Ω/Mft.	Solid PE Coded: Natural, Blue		100% Flexfoil® +57% Tinned Copper Braid 4.1 Ω/Mft.	Blue PVC		20.00 65.62	66	78	1 10 50 100 200 400	0.60 2.10 5.00 7.50 11.00 16.00	
		0.080	2.03		0.250	6.35						

Data subject to change.



# Specialty Cable



Prysmian offers a variety of Gepco® and CAROL® Brand wire and cable for audio/video and direct burial applications. From field production cable to microphone, snake, guitar and speaker cable, Prysmian supports the increasingly demanding entertainment industry.

For extreme hard service, Prysmian’s rubber microphone cables offer the ultimate in performance and service life. The rubber designs are highly flexible and designed to lie flat on studio floors, as well as provide high impact and abrasion resistance.

For outdoor and cold weather applications, microphone cable jacketed with Carolprene® provides the ultimate protection against ozone, oil and ultraviolet radiation.

These technically sophisticated cables are required to contain

sources of interference and to protect against difficulties where they are unavoidable. In addition to providing the needed electrical characteristics, the cables are properly designed to handle demanding conditions, such as microphone hum, handling noise, crosstalk, electrostatic hum, SCR noise and common ground noise—either on stage, in a studio or at a remote venue.

For more information on these cables or for other special applications, please contact your Prysmian sales representative.

Section	Page
Multi-Conductor, Flexfoil® Shield	132
Speaker Wire	133
Command® Series Home Entertainment Speaker Cable	134
CAROL® Brand DMX Lighting Control Cables	135
Special Audio, Communication & Instrumentation	136-137
Microphone Cable, Multi-Conductor, Carolprene	138
Irrigation and Landscape Lighting Solutions Guide	139-140
Low Voltage Sprinkler Wire Multi-Conductor, Carolprene	141

# Multi-Conductor, Flexfoil® Shield



CATALOG NUMBER	NO. OF COND.	AWG SIZE	COND. STRAND	NOM. INSULATION THICKNESS		NOM. JACKET THICKNESS		NOMINAL O.D.		NOM. CAP.*	
				in	mm	in	mm	in	mm	A	B
C1228A	2	24	19/36	0.008	0.20	0.022	0.56	0.135	3.43	27.0	48.5

\*A – Capacitance between conductors  
 \*B – Capacitance between one conductor and other conductors connected to shield  
 Data subject to change.

### COLOR CODE CHART

NO. OF COND.	COLOR
1	Black
2	Red

### COLOR CODE CHART

NO. OF COND.	COLOR
<b>Shielded</b>	
1	Black
2	Red
3	Green
4	Yellow
<b>Unshielded</b>	
1	Blue
2	White

### Product Construction:

#### Conductor:

- 24 AWG fully annealed stranded tinned copper per ASTM B-33

#### Insulation:

- Premium-grade, color-coded polypropylene
- Color code: See chart below

#### Shield:

- Conductive tape applied over the core
- 100% Flexfoil® aluminum/polyester, 25% overlap, minimum, foil facing in
- Stranded tinned copper drain wire

#### Jacket:

- PVC, black
- Temperature range: -20°C to +75°C

### Applications:

- Electronic circuits where RF shielding is required
- Radio Transmitters
- Sound Systems
- Recording Studios
- Suggested voltage rating: 300 volts

### Features:

- Excellent shielding to reduce noise

### Compliances:

- RoHS Compliant Directive 2015/863/EU (RoHS-3)

### Packaging:

- Please contact Customer Service for packaging and color options

# Speaker Wire

UL Listed or AWM Style 1007

**Product Construction:**

**Conductor:**

- 18 AWG tinned annealed stranded copper
- Stranded tinned copper per ASTM B33

**Insulation:**

- Premium-grade, color-coded PVC
- Temperature range: -30°C to +80°C
- Color code: See chart below

**Applications:**

- Audio systems
- Not for in-wall use

**Compliances:**

- UL Style 1007 (UL: 80°C, 300 V)
- AWM Style 1007
- RoHS Compliant Directive 2011/65/EU

**Packaging:**

- 1000' (305 m) reels



CATALOG NUMBER	NO. OF COND.	AWG SIZE	COND. STRAND	NOM. INSULATION THICKNESS		NOMINAL O.D.	
				in	mm	in	mm

**AWM STYLE 1007 (80°C, 300 V)**

<b>C7102A</b>	2	18	7/0152	0.020	0.51	0.172	4.37
---------------	---	----	--------	-------	------	-------	------

Data subject to change.

**COLOR CODE CHART**

ORDERING SUFFIX	STOCK COLOR
<b>99</b>	Black-White

**Product Construction:**

**Conductor:**

- 24 thru 12 AWG fully annealed one bare, one tin stranded copper per ASTM B174

**Insulation/Jacket:**

- Premium-grade PVC
- Color code: See chart below

**Applications:**

- Digital audio
- Hi-fi and stereo speaker wire
- Jukeboxes
- Not for in-wall use
- Home theater

**Compliances:**

- UL Wires Misc.
- RoHS Compliant Directive 2015/863/EU (RoHS-3)

**Packaging:**

- Please contact Customer Service for packaging and color options



CATALOG NUMBER	NUMBER OF COND.	AWG SIZE	COND. STRAND	NOM. INSULATION THICKNESS		NOMINAL O.D.	
				in	mm	in	mm

<b>C1356</b>	2	24	7/32	0.016	0.41	0.058x0.117	1.47x2.79
<b>C1362</b>	2	22	7/30	0.020	0.51	0.070x0.145	1.77x3.68
<b>C1360</b>	2	20	10/30	0.020	0.51	0.085x0.160	2.16x4.06
<b>C1357</b>	2	18	16/30	0.020	0.51	0.083x0.181	2.11x4.60
<b>C1358</b>	2	16	26/30	0.020	0.51	0.105x0.210	2.67x5.33
<b>C1361</b>	2	14	41/30	0.025	0.64	0.125x0.235	3.18x5.69
<b>C1363</b>	2	12	65/30	0.025	0.64	0.154x0.323	3.91x8.20

**COLOR CODE CHART**

ORDERING SUFFIX	COLORS
<b>01</b>	Black
<b>02</b>	White
<b>08</b>	Brown
<b>10</b>	Gray
<b>90</b>	Clear



# Command® Series Home Entertainment Speaker Cable

NEC Type CL3, CSA, CMG, AWM I/II A/B

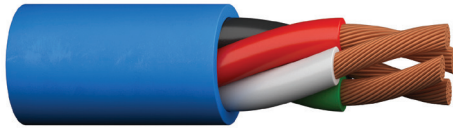

CATALOG NUMBER	NO. OF COND.	AWG SIZE	COND. STRAND	NOM. INSULATION WALL		NOM. JACKET THICKNESS		NOMINAL O.D.	
				in	mm	in	mm	in	mm
<b>C1700t</b>	2	12	65/30	0.009	0.15	0.021	0.53	0.254	6.45
<b>C1701t</b>	4	12	65/30	0.009	0.15	0.021	0.53	0.299	7.59
<b>C1702t</b>	2	14	41/30	0.009	0.15	0.021	0.53	0.220	5.59
<b>C1703t</b>	4	14	41/30	0.009	0.15	0.021	0.53	0.257	6.53
<b>C1704</b>	2	16	26/30	0.009	0.15	0.021	0.53	0.191	4.85
<b>C1705</b>	4	16	26/30	0.009	0.15	0.021	0.53	0.222	5.64

tCL3, CSA AWM I/II A/B only

### COLOR CODE CHART

NO. OF COND.	COLOR
<b>1</b>	Black
<b>2</b>	Red
<b>3</b>	White
<b>4</b>	Green

### Product Construction:

#### Conductor:

- 12, 14, 16, or 18 AWG fully annealed, stranded bare copper per ASTM B-8

#### Insulation:

- Premium-grade, color coded polypropylene
- Color code: see chart below

#### Jacket:

- PVC, command blue
- Temperature range: -20°C to +60°C

### Applications:

- Digital audio
- Stereo Systems
- In-wall speakers
- Home theatre
- Remote control circuits
- Security Systems
- Bi-amp speakers

### Features:

- Flexible

### Compliances:

- NEC Article 725 Type CL3 (UL: 60°C)
- CSA, CMG, AWM, I/II A/B
- RoHS Compliant Directive 2015/863/EU (RoHS-3)
- Designed to meet UL 70,000 BTU Vertical Tray Flame Test
- Passes CSA FT-4 Vertical Flame Test

### Packaging:

- Please contact Customer Service for packaging and color options

# CAROL® Brand DMX Lighting Control Cables

**Product Construction:**

**Conductor:**

- 22 AWG fully stranded tinned copper per ASTM B33
- Twisted pairs

**Insulation:**

- Foam PE, .025" Wall
- Color code: See chart below

**Shield:**

- 100% foil braid, 90% tinned copper braid
- Stranded tinned copper drain wire

**Jacket:**

- Flexible, durable TPU, black
- Temperature range: -40°C to +75°C

**Jacket Marking:**

- 1 Pair: CAROL® PRODUCTS —122 —DMX LIGHTING CONTROL CABLE 1 PAIR 22 AWG STRANDED
- 2 Pair: CAROL® PRODUCTS —222 —DMX LIGHTING CONTROL CABLE 2 PAIR 22 AWG STRANDED

**Applications:**

- DMX512 Lighting Control
- For Portable Use or Remote Environments

**Features:**

- True DMX512 construction
- Low-capacitance data pairs
- Drain wire for easy shield termination
- Color-coded conductors for easy identification
- One- or Two-Pair designs available
- Durable, flexible, all-weather jacket.

**Industry Approvals:**

- Meets or exceeds USITT standards

**Packaging:**

- 1000' (304.8m)
- Other put-ups available on special order



CATALOG NUMBER	NO. OF PAIRS	AWG SIZE	COND. STRAND	NOM. O.D. THICKNESS		NOMINAL O.D.		APPROX. NET WT. LBS/M	STD. CTN.
				in	mm	in	mm		
01220.41.01	1	22	7/30	0.245	6.22	0.245	6.22	33	1000'
02220.41.01	2	22	7/30	0.278	7.06	0.278	7.06	47	1000'

\*Capacitance between one conductor and other conductors connected to shield  
Data subject to change.

**COLOR CODE CHART**

NO. OF PAIRS	COLOR
1	Black, White
2	Black & White, Red & Blue

# Special Audio, Communication & Instrumentation

UL 2095, 2093

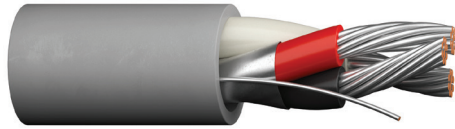

CATALOG NUMBER	NO. OF COND.	AWG SIZE	COND. STRAND	NOM. INSULATION THICKNESS		NOM. JACKET THICKNESS		NOMINAL O.D.		NOM. CAP.*	
				in	mm	in	mm	in	mm	A	B
<b>UL Style 2093, 300 VOLT</b>											
C1333A	3	2-20 Shielded 1-20 Unshielded	7/28	0.016	0.41	0.028	0.71	0.206	5.23	26.0	47.0

\*A – Capacitance between conductors  
 \*B – Capacitance between one conductor and other conductors connected to shield  
 Data subject to change.

**COLOR CODE CHART**

NO. OF COND.	COLOR
<b>Shielded</b>	
1	Black
2	Red
<b>Unshielded</b>	
1	Natural

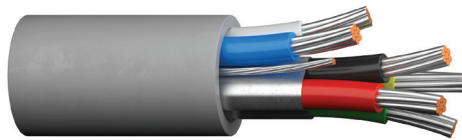

CATALOG NUMBER	NO. OF COND.	AWG SIZE	COND. STRAND	NOM. INSULATION THICKNESS		NOM. JACKET THICKNESS		NOMINAL O.D.		NOM. CAP.*	
				in	mm	in	mm	in	mm	A	B
<b>UL Style 2095, 300 VOLT</b>											
C1345A	6	4-24 Shielded 2-22 Unshielded	7/32 7/30	0.015	0.38	0.025	0.64	0.230	5.84	32.0	57.0

\*A – Capacitance between conductors  
 \*B – Capacitance between one conductor and other conductors connected to shield  
 Data subject to change.

**COLOR CODE CHART**

NO. OF COND.	COLOR
<b>Shielded</b>	
1	Black
2	Red
3	Green
4	Yellow
<b>Unshielded</b>	
1	Blue
2	White

**Product Construction:**

**Conductor:**

- 24 thru 20 AWG fully annealed stranded tinned copper per ASTM B33

**Insulation:**

- Premium-grade, color-coded polyethylene (C1333A) or PVC (C1345A)
- Color code: See chart below

**Shield:**

- 100% Flexfoil® aluminum/polyester foil with 25% overlap, minimum, foil facing out
- Stranded tinned copper drain wire

**Jacket:**

- PVC, gray
- Temperature range: -20°C to +80°C

**Applications:**

- Audio
- Communications
- EMI isolated circuits for instrumentation
- Suggested voltage rating: 300 volts

**Compliances:**

- UL Style 2093 (UL: 60°C, 300 V)
- UL Style 2095 (UL: 80°C, 300 V)
- RoHS Compliant Directive 2015/863/EU (RoHS-3)

**Packaging:**

- Please contact Customer Service for packaging and color options



# Special Audio, Communication & Instrumentation

UL 2095, UL 2835, UL 2094, NEC Type CL2

**Product Construction:**

**Conductor:**

- 22 thru 18 AWG fully annealed stranded tinned copper per ASTM B33

**Insulation:**

- C1331A - Premium-grade, color-coded PVC
- C1340A - Premium-grade, color-coded polypropylene
- C1343A - Premium-grade, color-coded polyethylene
- Color code: See chart below

**Shield:**

- 100% Flexfoil® aluminum/polyester over two conductors, 25% overlap, minimum, foil facing out
- Stranded tinned copper drain wire

**Jacket:**

- PVC, gray
- Temperature range: -20°C to +105°C

**Applications:**

- Audio
- Communications
- EMI isolated circuits for instrumentation

**Compliances:**

- NEC Article 725 Type CL2 (UL: 75°C, 150 V)
- C1331A - UL Style 2095 (UL: 105°C)
- C1340A - UL Style 2835 (UL: 105°C)
- C1343A - UL Style 2094 (UL: 105°C)
- RoHS Compliant Directive 2015/863/EU (RoHS-3)

**Packaging:**

- Please contact Customer Service for packaging and color options

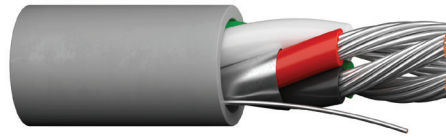

CATALOG NUMBER	NO. OF COND.	AWG SIZE	COND. STRAND	NOM. INSULATION THICKNESS		NOM. JACKET THICKNESS		NOMINAL O.D.		NOM. CAP.* pF/ft	
				in	mm	in	mm	in	mm	A	B

**UL Style 2095, NEC Type CL2**

<b>C1331A</b>	4	2-20 Shielded 2-20 Unshielded	7/28	0.016	0.41	0.032	0.81	0.230	5.84	41.0	74.0
---------------	---	----------------------------------	------	-------	------	-------	------	-------	------	------	------

**UL Style 2835**

<b>C1340A</b>	4	2-22 Shielded 2-22 Unshielded	7/30	0.008	0.20	0.017	0.43	0.161	4.09	29.0	52.0
---------------	---	----------------------------------	------	-------	------	-------	------	-------	------	------	------

**UL Style 2094**

<b>C1343A</b>	4	2-20 Shielded 2-18 Unshielded	7/28 16/30	0.018	0.46	0.032	0.81	0.259	6.58	27.0	49.0
---------------	---	----------------------------------	---------------	-------	------	-------	------	-------	------	------	------

\*A – Capacitance between conductors

\*B – Capacitance between one conductor and other conductors connected to shield  
Data subject to change.

**COLOR CODE CHART**

NO. OF COND.	COLOR
<b>Shielded</b>	
1	Black
2	Red
<b>Unshielded</b>	
1	Green
2	White

# Microphone Cable, Multi-Conductor, Carolprene®

High and Low Impedance

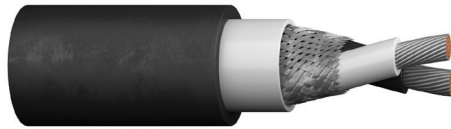

**Product Construction:**

**Conductor:**

- 18 and 16 AWG fully annealed stranded tinned copper per ASTM B33

**Insulation:**

- Premium-grade, color-coded rubber
- Color code: See chart below

**Shield:**

- 80% braid tinned copper

**Jacket:**

- Carolprene®, black
- Temperature range: -20°C to +60°C

**Applications:**

**C1201:**

- High-impedance microphones
- Broadcast and studio use
- Communication and audio systems
- Suggested voltage rating: 300 volts

**C1202, C1602:**

- Low-impedance microphones
- Studio use
- Control circuits
- Video and interconnecting cables
- Shielded power supplies
- Suggested voltage rating: 300 volts

**Features:**

- Precision engineered to transmit clear, noise-free signals
- Minimizes electrical "hum"
- Resistant to oil, acid, sunlight, abrasion and aging
- Excellent noise rejection

**Compliances:**

- RoHS Compliant Directive 2015/863/EU (RoHS-3)

**Packaging:**

- Please contact Customer Service for packaging and color options

CATALOG NUMBER	NO. OF COND.	AWG SIZE	COND. STRAND	NOM. INSULATION THICKNESS		NOM. JACKET THICKNESS		NOMINAL O.D.		NOM. CAP.* pF/ft
				in	mm	in	mm	in	mm	
C1201	1	18	41/34	0.040	1.02	0.035	0.89	0.240	6.10	46.0
C1202	2	18	41/34	0.020	0.51	0.035	0.89	0.295	7.49	61.0
C1602	2	16	65/34	0.025	0.64	0.035	0.89	0.335	8.51	55.0

\*Capacitance between one conductor and other conductors connected to shield  
Data subject to change.

**COLOR CODE CHART**

NO. OF COND.	COLOR
1	White
2	Black



# Irrigation & Landscape Lighting

## SOLUTIONS GUIDE

### Underground Low-Voltage Sprinkler Wire 18 AWG Multi-Conductor PVC Insulated, PE Jacketed

**Applications:**

- For use in wiring irrigation control systems where cable must be suitable for direct burial
- Low-voltage golf course satellite sprinkler control
- Residential sprinkler solenoid control

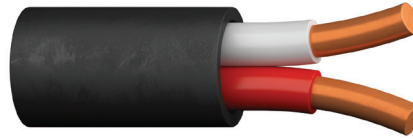

**Standard Put-Ups:**

- 250'
- 500'
- 1000'
- 2500'

**Standard Color Code:**

- Black jacket
- Refer to Color Code Chart on back for insulation

ISOTEC PART NUMBER	NO. OF COND.	NOM. INS. THICKNESS INCHES	JACKET THICKNESS INCHES	NOMINAL O.D. INCHES	WEIGHT PER MFT
182IRRAP	2	.016	.025	.183	21
183IRRAP	3	.016	.025	.216	29
184IRRAP	4	.016	.025	.236	37
185IRRAP	5	.016	.025	.250	45
186IRRAP	6	.016	.025	.266	52
187IRRAP	7	.016	.025	.280	59
188IRRAP	8	.016	.025	.300	67
1810IRRAP	10	.016	.025	.327	81
1812IRRAP	12	.016	.025	.355	96
1813IRRAP	13	.016	.025	.368	104

### Communication & Control Cable 18 & 20 AWG Multi-Paired, PE Insulated

**Applications:**

- For use with golf course irrigation control systems

**Standard Put-Ups:**

- 500'
- 1000'

**Standard Color Code:**

- Black jacket
- Refer to Color Code Chart on back for insulation



ISOTEC PART NUMBER	NO. OF COND.	AWG/STRANDING	INSULATION THICKNESS & TYPE	JACKET THICKNESS & TYPE	NOMINAL O.D. INCHES
C6061A	Individually Shld. 3 PR w/20 AWG Stranded T.C. Drain	10/30 Tinned Copper	.013" Polypropylene	.047" Polyethylene	.340

# Irrigation & Landscape Lighting

## SOLUTIONS GUIDE

### Underground Feeder (UF) Cable 600 V Single Conductor, PVC Insulated

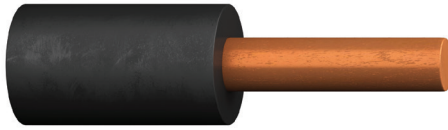

**Applications:**

- For use in irrigation as described in Article 339 of the National Electric Code (NEC)
- 18 AWG and 16 AWG are not permitted to be UL Listed as Type UF\*

**Standard Put-Ups:**

- 500'
- 1000'
- 2500'

**Standard Colors:**

- Please consult customer service for information on available colors

ISOTEC PART NUMBER	AWG/STRANDING	INSULATION THICKNESS INCHES	NOMINAL O.D. INCHES	WEIGHT PER MFT
<b>181UF*</b>	18 (Solid)	0.045	0.134	13
<b>161UF*</b>	16 (Solid)	0.045	0.144	17
<b>141UF</b>	14 (Solid)	0.060	0.186	28
<b>121UF</b>	12 (Solid)	0.060	0.205	37
<b>101UF</b>	10 (Solid)	0.060	0.225	52

Note: PE UF cable is available upon special request. Please consult customer service.

### Underground Low-Voltage Landscape Lighting Cable 150 V Flat Parallel, PVC Insulated



**Applications:**

- For use in wiring low-voltage outdoor landscape lighting and security lighting circuits where cable must be suitable for direct burial

**Standard Put-Ups:**

- 250'
- 500'
- 1000'

**Standard Jacket Color:**

- Black

ISOTEC PART NUMBER	AWG/STRANDING	NOM. INS. THICKNESS INCHES	NOMINAL O.D. INCHES	WEIGHT PER MFT
<b>182ULC00</b>	18 16/30 B/C	0.041	.209 X .145	26
<b>162ULC00</b>	16 26/30 B/C	0.041	.315 X .155	36
<b>142ULC00</b>	14 41/30 B/C	0.041	.350 X .170	46
<b>122ULC00</b>	12 65/30 B/C	0.041	.390 X .195	86
<b>102ULC00</b>	10 105/30 B/C	0.062	.470 X .240	122
<b>802ULC00</b>	8 133/0125 B/C	0.078	.630 X .316	199

# Low-Voltage Sprinkler Wire

60°C 30 Volts UL

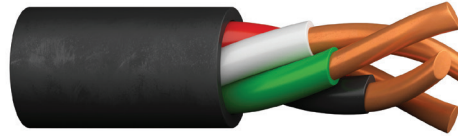

CATALOG NUMBER	NO. OF COND.	AWG SIZE	LENGTH OF CORD (FEET)	PACKAGE TYPE	POWER RATING <sup>(1)</sup>			PKG PER CTN.	APPROX. WEIGHT PER CTN (LBS) <sup>(5)</sup>	CARTON DIMENSIONS (H x W x D)	UPC NUMBER
					VOLTS	AMPS	WATTS				
<b>LOW VOLTAGE SPRINKLER WIRE - 30 VOLTS - UL</b>											
23804.18.01	4	18	500	Spool	30	15	450	1	18	10.625 x 10.625 x 6.313	079407908047
23815.60.01	5	18	50	Cuff	30	15	450	6	13	8.5 x 12.25 x 14	079407238156
23825.60.01	5	18	100	Cuff	30	15	450	6	27	9.5 x 14 x 17	079407238255
23805.18.01	5	18	500	Spool	30	15	450	1	22	10.625 x 10.625 x 6.313	079407908054
23817.60.01	7	18	50	Cuff	30	15	450	6	18	8.5 x 12.25 x 14	079407238170
23827.60.01	7	18	100	Cuff	30	15	450	6	36	9.5 x 14 x 17	079407238279
23807.18.01	7	18	500	Spool	30	15	450	1	31	10.625 x 10.625 x 6.313	079407908078
23810.18.01	10	18	500	Reel	30	15	450	1	44	—	079407908108

(1) Amps and watts are offered ONLY as a guide to the end user.  
 (5) Actual shipping weight may vary.  
 Data subject to change.

**Product Construction:**

**Conductor:**

- 18 AWG fully annealed solid bare copper per ASTM B3

**Insulation:**

- Premium-grade, color-coded PVC
- Premium-grade PE jacket, black
- Nylon rip cord to facilitate jacket removal
- Temperature range: -20°C to +60°C
- Color code: See chart at left

**Jacket Marking:**

- CAROL (SIZE) 30 V SPRINKLER SYSTEMS WIRE
- DIRECT BURIAL E54567 (UL)

**Applications:**

- Low-voltage golf course satellite sprinkler control
- Residential sprinkler solenoid control

**Compliances:**

- UL Listed under a UL Miscellaneous Wire file
- UL Listed for outdoors applications
- UL Listed for direct burial applications

**Packaging:**

- See tabular data above
- Please contact Customer Service for packaging and color options

**COLOR CODE CHART**

NO. OF COND.	COLOR	NO. OF COND.	COLOR	NO. OF COND.	COLOR
1	Black	5	Orange	9	Gray
2	White	6	Yellow	10	Purple
3	Red	7	BLue		
4	Green	8	Brown		

# Hook-Up Wire

# 10

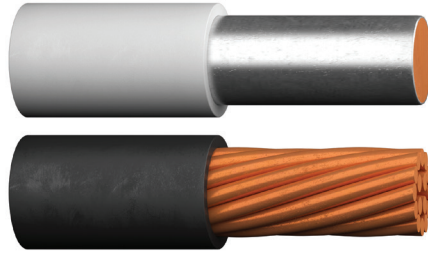

Most applications of hook-up and lead wire for board-to-board or point-to-point wiring rely on PVC-insulated designs.

Prysmian’s CAROL® Brand products offer both electrical and electronic designers a vast array of quality PVC hook-up wire to meet the specific technical demands of today, with “off-the-shelf” distributor inventoried products.

Hook-up wire is also available in special colors and/or stripe combinations with a minimum of lead time. In addition, Prysmian offers a variety of put-ups to meet individual customer requirements.

Section	Page
UL 1007, UL 1569, CSA TR-64	143
UL 1015, CSA TEW	144
UL Types MTW, TFF, AWM & CSA TEW	145
Heavy Wall UL Types MTW, AWM, NEC Type THW and CSA TEW	146
Rubber/PVC/Polyethylene	147

# UL 1007, UL 1569, CSA TR-64

**Product Construction:**

**Conductor:**

- 24 thru 16 AWG
- Fully annealed tinned copper per ASTM B33
- Solid or stranded

**Insulation:**

- Premium-grade, color-coded PVC
- Temperature range: -20°C to +105°C
- Color code: See chart below

**Applications:**

- Internal wiring of electrical and electronic equipment
- Internal wiring of panels and meters
- Point-to-point wiring
- Suggested voltage rating: 300 volts

**Compliances:**

- UL Style 1007 (UL: 80°C, 300 V)
- CSA TR-64: 90°C, 300 V
- RoHS Compliant Directive 2015/863/EU (RoHS-3)
- Designed to meet UL VW-1 Vertical Wire Flame Test

**Packaging:**

- Please contact Customer Service for packaging and color options

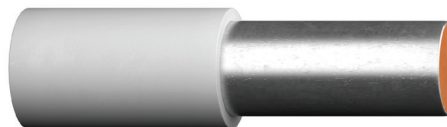

CATALOG NUMBER	AWG SIZE	COND. STRAND	NOM. INSULATION THICKNESS		NOMINAL O.D.	
			in	mm	in	mm
<b>SOLID CONDUCTORS</b>						
<b>C2003A</b>	24	Solid	0.016	0.41	0.052	1.32
<b>C2004A</b>	22	Solid	0.016	0.41	0.057	1.45
<b>C2028A</b>	20	Solid	0.016	0.41	0.064	1.63
<b>C2052A</b>	18	Solid	0.016	0.41	0.072	1.83
<b>C2053A</b>	16	Solid	0.016	0.41	0.083	2.11
<b>STRANDED CONDUCTORS</b>						
<b>C2015A</b>	24	7/32	0.016	0.41	0.056	1.42
<b>C2016A</b>	22	7/30	0.016	0.41	0.062	1.57
<b>C2040A</b>	20	10/30	0.016	0.41	0.070	1.78
<b>C2064A</b>	18	16/30	0.016	0.41	0.080	2.03
<b>C2065A</b>	16	26/30	0.016	0.41	0.092	2.34

Data subject to change.

**COLOR CODE CHART**

ORDERING SUFFIX	COLOR	ORDERING SUFFIX	COLOR
<b>01</b>	Black	<b>06</b>	Green
<b>02</b>	White	<b>07</b>	Blue
<b>03</b>	Red	<b>08</b>	Brown
<b>04</b>	Orange	<b>10</b>	Gray
<b>05</b>	Yellow	<b>19</b>	Purple

Striped combinations available upon request; consult Customer Service.



# UL 1015, CSA TEW

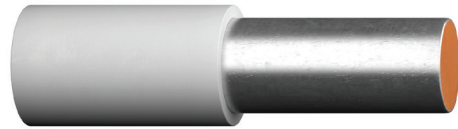

**Product Construction:**

**Conductor:**

- 24 thru 10 AWG
- Fully annealed tinned copper per ASTM B33
- Solid or stranded

**Insulation:**

- Premium-grade, color-coded PVC
- Temperature range: -30°C to +105°C
- Color code: See chart below

**Applications:**

- Internal wiring of electrical and electronic equipment
- Internal wiring of panels and meters
- Point-to-point wiring
- Suggested voltage rating: 600 volts

**Compliances:**

- UL Style 1015 (UL: 105°C, 600 V)
- CSA Type TEW: 105°C, 600 V
- RoHS Compliant Directive 2015/863/EU (RoHS-3)
- Designed to meet UL VW-1 Vertical Wire Flame Test

**Packaging:**

- Please contact Customer Service for packaging and color options

CATALOG NUMBER	AWG SIZE	COND. STRAND	NOM. INSULATION THICKNESS		NOMINAL O.D.	
			in	mm	in	mm
<b>SOLID CONDUCTORS</b>						
C2117A	22	Solid	0.032	0.81	0.089	2.26
C2118A	20	Solid	0.032	0.81	0.096	2.44
C2119A	18	Solid	0.032	0.81	0.104	2.64
<b>STRANDED CONDUCTORS</b>						
C2100A	24	7/32	0.032	0.81	0.088	2.24
C2101A	22	7/30	0.032	0.81	0.094	2.39
C2102A	20	10/30	0.032	0.81	0.102	2.59
C2103A	18	16/30	0.032	0.81	0.112	2.84
C2104A	16	26/30	0.032	0.81	0.124	3.15
C2105A	14	41/30	0.032	0.81	0.141	3.58
C2106A	12	65/30	0.032	0.81	0.160	4.06
C2107A	10	105/30	0.033	0.84	0.184	4.67

Data subject to change.

**COLOR CODE CHART**

ORDERING SUFFIX	COLOR	ORDERING SUFFIX	COLOR
01	Black	06	Green
02	White	07	Blue
03	Red	08	Brown
04	Orange	10	Gray
05	Yellow	19	Purple

Striped combinations available upon request; consult Customer Service.



# UL Types MTW, TFF, AWM & CSA TEW

90°C 600 Volt MTW, TFF 105°C 600 Volt AWM/TEW

**Product Construction:**

**Conductor:**

- 18 through 8 AWG fully annealed stranded bare copper per ASTM B8

**Insulation:**

- Premium-grade, color-coded PVC
- Temperature range:
  - MTW: -40°C to +90°C
  - AWM: -40°C to +105°C
  - TEW: -30°C to +105°C
- Color code: See chart below

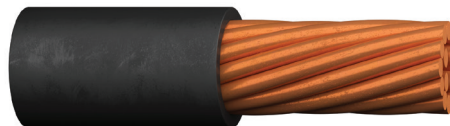

**Jacket Marking:**

- 18 and 16 AWG: CAROL (SIZE) 600 V E# MTW (UL) OR TFF OR 1000 V AWM VW-1 --- CSA TEW 105°C FT1 ROHS MADE IN USA
- 14 through 8 AWG: CAROL (SIZE) 600 V E# MTW (UL) OR 1000 V AWM VW-1 --- CSA TEW 105°C FT1 ROHS MADE IN USA

**Applications:**

- Motor and transformer lead
- External wiring of machinery
- Internal wiring of electrical and electronic equipment
- Internal wiring of panels and meters
- Point-to-point wiring

**Features:**

- Outstanding oil, flame and moisture resistance
- Extra flexible

**Compliances:**

- UL and NMTBA Type MTW/AWM
- CSA TEW
- RoHS Compliant Directive 2015/863/EU (RoHS-3)
- Passes VW-1 Vertical Flame Test
- AWM Style 1015 – 18-8 AWG
- AWM Style 1335 – 18-10 AWG
- AWM Style 1336 – 8 AWG
- UL 1032 1000 V

**Packaging:**

- Please contact Customer Service for packaging and color options

CATALOG NUMBER	AWG SIZE	COND. STRAND	NOM. INSULATION THICKNESS		NOMINAL O.D.		STOCK COLORS	APPROX. NET WEIGHT LBS/M <sup>(S)</sup>
			in	mm	in	mm		
<b>UL TYPE MTW, AWM, TFF, CSA TYPE TEW-600 VOLT</b>								
<b>76502</b>	18	16/30	0.032	0.81	0.110	2.79	1-12	10
<b>76512</b>	16	26/30	0.032	0.81	0.123	3.12	1-12	14
<b>76812</b>	14	19/0159	0.032	0.81	0.136	3.40	1-12	20
<b>76822</b>	12	19/0185	0.032	0.81	0.155	3.91	1-7	28
<b>76832</b>	10	19/0234	0.032	0.81	0.179	4.55	1-5	42
<b>76843</b>	8	19/0295	0.047	1.19	0.242	6.15	1-5	72

<sup>(S)</sup> Actual shipping weight may vary. Data subject to change.

**COLOR CODE CHART**

ORDERING SUFFIX	COLOR	ORDERING SUFFIX	COLOR
<b>01</b>	Black	<b>07</b>	Blue
<b>02</b>	White	<b>08</b>	Brown
<b>03</b>	Red	<b>10</b>	Gray
<b>04</b>	Orange	<b>13</b>	Pink
<b>06</b>	Green	<b>19</b>	Purple



# Heavy Wall UL Types MTW, AWM, NEC Type THW and CSA TEW

90°C 600 Volts

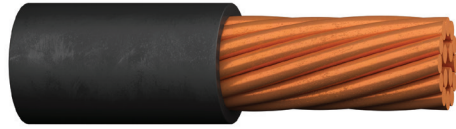

CATALOG NUMBER	AWG SIZE	COND. STRAND	NOM. INSULATION THICKNESS		NOMINAL O.D.		APPROX. NET WEIGHT LBS/m <sup>(5)</sup>
			in	mm	in	mm	
<b>AWM, MTW, THW - 600 VOLT - UL</b>							
<b>76954</b>	6	19/0372	0.064	1.63	0.315	8.00	110
<b>76994</b>	4	19/0469	0.065	1.65	0.365	9.27	150

<sup>(5)</sup>Actual shipping weight may vary.  
Data subject to change.

**Product Construction:**

**Conductor:**

- 6 and 4 AWG fully annealed stranded bare copper per ASTM B8

**Insulation:**

- Premium-grade, color-coded PVC, black
- Temperature range:  
MTW: -40°C to +90°C  
AWM: -40°C to +105°C  
TEW: -30°C to +105°C

**Jacket Marking:**

- CAROL (SIZE) 600 V E# MTW OR THW (UL) OR 1000 V AWM VW-1 --- CSA TEW 105°C FT1 ROHS MADE IN USA

**Applications:**

- Motor and transformer lead
- External wiring of machinery

**Features:**

- Outstanding oil, flame and moisture resistance
- Extra flexible

**Compliances:**

- UL Type AWM
- UL and NMTBA Type MTW
- NEC Type THW
- CSA TEW
- RoHS Compliant Directive 2015/863/EU (RoHS-3)
- Passes UL VW-1 Vertical Flame Test

**Packaging:**

- Please contact Customer Service for packaging and color options





# Rubber/PVC/Polyethylene

**Product Construction:**

**Conductor:**

- 20, 18 and 14 AWG fully annealed stranded tinned copper per ASTM B33

**Insulation:**

- Premium-grade, color-coded rubber, PVC or polyethylene
- Temperature range:
  - 40°C to +90°C rubber
  - 30°C to +105°C PVC
  - 60°C to +80°C polyethylene
- Color code: See chart below

**Applications:**

- Test equipment
- Oscilloscopes

**Compliances:**

- RoHS Compliant Directive 2015/863/EU (RoHS-3)

**Packaging:**

- Please contact Customer Service for packaging and color options

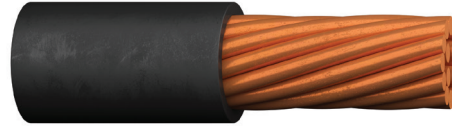

CATALOG NUMBER	NO. OF COND.	AWG SIZE	COND. STRAND	NOM. INSULATION THICKNESS		BREAKDOWN VOLTAGE (AC, rms)	WORKING VOLTAGE*	NOMINAL O.D.	
				in	mm			in	mm

**RUBBER TEST LEAD**

<b>C1326</b>	1	20	41/36	0.040	1.02	6,000V	1,500V	0.125	3.18
<b>C1319</b>	1	20	41/36	0.047	1.19	12,000V	3,000V	0.140	3.56
<b>C1321</b>	1	18	65/36	0.045	1.14	20,000V	5,000V	0.145	3.68
<b>C1318</b>	1	18	65/36	0.088	2.24	29,000V	10,000V	0.230	5.84

**PVC TEST LEAD**

<b>C1320A</b>	1	18	65/36	0.047	1.19	20,000V	5,000V	0.140	3.56
---------------	---	----	-------	-------	------	---------	--------	-------	------

**POLYETHYLENE TEST LEAD**

<b>C7108A</b>	1	14	105/34	0.032	0.81	4,000V	600V	0.140	3.56
---------------	---	----	--------	-------	------	--------	------	-------	------

\*For intermittent duty only.  
Data subject to change.

**COLOR CODE CHART**

ORDERING SUFFIX	COLOR
<b>01</b>	Black
<b>03</b>	Red
<b>06</b>	Green

## Notes:

# Technical Information

As technology becomes more complex, specifying wire and cable products to meet system performance demands becomes more time-consuming and complex.

Today's system designer must be aware not only of the general transmission line types, but also of the myriad of materials available to meet specific environmental or electrical performance criteria.

This technical section is presented to aid in the selection of materials and designs which will best suit the combination of hardware and transmission media.

For technical questions regarding specific transmission designs or applications, please contact Prysmian's Engineering Department.

<b>Section</b>	<b>Page</b>
Insulation & Jacket Properties	150
Decimal Conversion Factors	151
Unit Conversion Factors	152
Temperature Conversion Chart	153
Conduit Capacity Chart	154
AWG Conductor Chart	155
Glossary	156-166
Abbreviations & Acronyms	167-169
Hook-Up Wire Product Finder	170
Multi-Conductor Cable Product Finder	171-176
Belden to CAROL Brand Catalog Cross Reference Index	177-178
NEC/CEC Substitution Chart	179-180
Agency Symbols	181
Put-Ups and Color Codes	182

# Insulation & Jacket Properties

**TYPICAL PROPERTIES OF COMMON INSULATING MATERIALS**

PARAMETER	PVC	PE	PP	XLPE	NYLON	FEP	TFE	BUTYL RUBBER	SILICONE RUBBER	TPR
Specific Gravity	1.37	0.92	0.89	0.93-1.18	1.09	2.16	2.17	1.40	1.24	1.16-1.20
Dielectric Constant (a) 60 Hz (b) 1000 Hz	6.0 5.0	2.26 2.26	2.6	3.0 3.0	4.6 4.5	2.15 2.15	2.1 2.1	4.1 4.0	3.3 3.1	2.8 2.8
Dielectric Strength, v/mil (a) 0.010" wall (b) 0.040" wall	1800 800	2100 1050	850 450	- 700	1000 470	2000 950	2000 950	700 500	600 400	625
Tensile Strength, PSI x 1000	1.5-3.8	1.4-2.4	2.9-4.5	1.8-2.5	8.8-11.9	2.3-3.1	2.0-6.0	0.5-1.5	0.6-1.2	2.3
Service Temp, Range, °C	-55/+105	-90/+90	-40/+105	-80/+75	-55/+105	-90/+200	-90/+260	-40/+90	-80/+200	-55/+90
Elongation, %	200-375	350-550	700	250-400	150-380	200-330	200-500	200-400	125-400	500
Water Absorption, % in 24 hr	<0.75	<0.02	<0.02	<0.01	2.5	<0.01	<0.01	<1.0	<1.0	<0.6
Flame Resistance	Self Extinguishing	Supports Flame	Supports Flame	Slow Flame	Self Extinguishing	Non-Flammable	Non-Flammable	Slow Burning	Slow (Non-Cond. Ash)	Flammable
Ozone Resistance	Excellent	Good	Excellent	Good	Good	Excellent	Excellent	Excellent	Excellent	Excellent
Flexibility	Good	Good	Good	Good-Fair	Good-Fair	Good	Good	Excellent	Excellent	Excellent
Abrasion Resistance	Good	Good	Fair	Excellent	Excellent	Excellent	Excellent	Poor	Poor	Good-Fair
Acid Resistance	Excellent	Excellent	Excellent	Excellent	Excellent	Poor	Excellent	Excellent	Good	Excellent
Base Resistance	Excellent	Excellent	Excellent	Excellent	Excellent	Excellent	Excellent	Good	Good	Excellent
Hydraulic Fluid Resistance	Good-Fair	Fair-Poor	Fair	Good-Fair	Good-Fair	Excellent	Excellent	Poor	Fair-Poor	Poor
Organic Solvent Resistance	Fair-Poor	Poor	Fair	Fair	Good-Fair	Excellent	Excellent	Good-Fair	Poor	Poor

NOTE: The above is representative of performance. For specific compound performance, consult Customer Service.

**TYPICAL PROPERTIES OF COMMON JACKETING MATERIALS**

PARAMETER	PVC	PE	NYLON	FEP	TFE	SILICONE RUBBER	NEOPRENE	POLY-URETHANE	TPR
Specific Gravity	1.37	0.92	1.09	2.16	2.17	1.24	1.52	1.3	1.16-1.20
Tensile Strength, PSI x 1000	1.5-3.8	1.4-2.4	8.8-11.9	2.3-3.1	2.0-6.0	0.6-1.2	2.5-4.0	>3.5	2.3
Elongation, %	200-375	350-550	150-380	200-330	200-500	125-400	300-500	540-700	500
Service Temp, Range, °C	-55/+105	-80/+75	-55/+105	-90/+200	-90/+200	-80/+200	-65/+90	-65/+75	-55/+90
Ozone Resistance	Excellent	Good	Good	Excellent	Excellent	Excellent	Excellent	Good	Excellent
Weatherability	Good-Fair	Excellent-Good	Fair-Poor	Excellent	Excellent	Excellent	Good	Good	Excellent
Flame Resistance	Self Extinguishing	Supports Flame	Flammable	Non-Flammable	Non-Flammable	Slow-Burn (Non-Cond. Ash)	Self Extinguishing	Slow Burn	Flammable
Flexibility	Good	Good	Good-Fair	Good	Good	Excellent	Excellent	Excellent	Excellent
Abrasion Resistance	Good	Good	Excellent	Excellent	Excellent	Poor	Excellent	Excellent	Good-Fair
Acid Resistance	Excellent	Excellent	Poor	Excellent	Excellent	Poor	Good	Fair	Excellent
Base Resistance	Excellent	Excellent	Excellent	Excellent	Excellent	Good	Good	Fair	Excellent
Hydraulic Fluid Resistance	Good-Fair	Fair-Poor	Good-Fair	Excellent	Excellent	Fair-Poor	Good	Poor	Good
Organic Solvent Resistance	Fair-Poor	Poor	Good-Fair	Excellent	Excellent	Poor	Good	Poor	Poor
Resistance to Tearing	Good	Good	Excellent	Good	Good	Fair	Good	Excellent	Good-Fair

NOTE: The above is representative of performance. For specific compound performance, consult Customer Service.



# Decimal Conversion Factors

FRACTIONS, DECIMALS AND MILLIMETER CONVERSION CHART

FRACTIONS OF AN INCH						EQUIVALENTS		FRACTIONS OF AN INCH						EQUIVALENTS	
64	32	16	8	4	2	DECIMALS	mm	64	32	16	8	4	2	DECIMALS	mm
1						0.016	0.40	33						0.516	13.10
2	1					0.031	0.79	34	17					0.531	13.49
3						0.047	1.19	35						0.547	13.89
4	2	1				0.063	1.59	36	18	9				0.563	14.29
5						0.078	1.98	37						0.578	14.68
6	3					0.094	2.38	38	19					0.594	15.08
7						0.109	2.78	39						0.609	15.48
8	4	2	1			0.125	3.18	40	20	10	5			0.625	15.88
9						0.141	3.57	41						0.641	16.27
10	5					0.156	3.97	42	21					0.656	16.67
11						0.172	4.37	43						0.672	17.07
12	6	3				0.188	4.76	44	22	11				0.688	17.46
13						0.203	5.16	45						0.703	17.86
14	7					0.219	5.56	46	23					0.719	18.26
15						0.234	5.95	47						0.734	18.65
16	8	4	2	1		0.250	6.35	48	24	12	6	3		0.750	19.05
17						0.266	6.75	49						0.766	19.45
18	9					0.281	7.14	50	25					0.781	19.84
19						0.297	7.54	51						0.797	20.24
20	10	5				0.313	7.94	52	26	13				0.813	20.64
21						0.328	8.33	53						0.828	21.03
22	11					0.344	8.73	54	27					0.844	21.43
23						0.359	9.13	55						0.859	21.83
24	12	6	3			0.375	9.53	56	28	14	7			0.875	22.23
25						0.391	9.92	57						0.891	22.62
26	13					0.406	10.32	58	29					0.906	23.02
27						0.422	10.72	59						0.922	23.42
28	14	7				0.438	11.11	60	30	15				0.938	23.81
29						0.453	11.51	61						0.953	24.21
30	15					0.469	11.91	62	31					0.969	24.61
31						0.484	12.30	63						0.984	25.00
32	16	8	4	2	1	0.500	12.70	64	32	16	8	4	2	1.000	25.40

# Unit Conversion Factors

## CONVERSION FACTORS

UNIT	X	CONSTANT	=	UNIT	UNIT	X	CONSTANT	=	UNIT
British Thermal Unit (BTU)		778.0		foot-pound (ft-lb)	gallons (gal)		3.785411		liters (l)
British Thermal Unit (BTU)		1054.35		joules (j)	gallons (gal)		0.13368		cubic foot (ft <sup>3</sup> )
British Thermal Unit (BTU)		0.293		watt-hours (w-hr)	gallons (gal)		231.0		cubic inch (in <sup>3</sup> )
British Thermal Unit (BTU)		0.032808		feet (ft)	gallons (gal)		3785.411		cubic centimeter (cm <sup>3</sup> )
British Thermal Unit (BTU)		0.3937		inches (in)	grams (g)		15.432		grains
centimeters (cm)		0.00001		kilometers (km)	gram/centimeter <sup>3</sup> (gm/cm <sup>3</sup> )		0.0361275		pounds/in <sup>3</sup> (lb/in <sup>3</sup> )
centimeters (cm)		0.010		meters (m)	horsepower (hp)		33013.26		ft-lb/min
centimeters (cm)		10.0		millimeters (mm)	horsepower (hp)		550.0		ft-lb/sec
centimeters (cm)		0.00064516		circular millimeters	horsepower (hp)		745.7		watts (w)
centimeters (cm)		0.0000007854		inches <sup>2</sup> (in <sup>2</sup> )	horsepower (hp)		0.027178		yards (yd)
centimeters (cm)		0.00050671		square millimeters	inch (in)		0.083333		feet (ft)
circular mils (cmil)		0.7854		(mm <sup>2</sup> )	inch (in)		0.00002540		kilometer (km)
circular mils (cmil)		0.000035314		mils <sup>2</sup>	inch (in)		0.025400		meter (m)
circular mils (cmil)		0.061023		cubic foot (ft <sup>3</sup> )	inch (in)		2.54000514		centimeter (cm)
circular mils (cmil)		0.000001		cubic inch (in <sup>3</sup> )	inch (in)		25.4000514		millimeter (mm)
cubic centimeter (cm <sup>3</sup> )		0.00026417		cubic meter (m <sup>3</sup> )	inch (in)		1000.0		mils
cubic centimeter (cm <sup>3</sup> )		1728.0		gallons (gal)	inch (in)		0.000948		British Thermal Unit (BTU)
cubic centimeter (cm <sup>3</sup> )		28317.847		cubic in (in <sup>3</sup> )	joules (j)		10 <sup>7</sup>		ergs
cubic centimeter (cm <sup>3</sup> )		0.00057870		cubic centimeter (cm <sup>3</sup> )	joules (j)		61.02374		cubic inch (in <sup>3</sup> )
cubic foot (ft <sup>3</sup> )		0.000016387		cubic feet (ft <sup>3</sup> )	liters (l)		1.093611		yard (yd)
cubic foot (ft <sup>3</sup> )		16.387064		cubic meter (m <sup>3</sup> )	meters (m)		3.2808333		feet (ft)
cubic inch (in <sup>3</sup> )		1000000.0		cubic centimeter (cm <sup>3</sup> )	meters (m)		39.37		inch (in)
cubic inch (in <sup>3</sup> )		35.314666		centimeter (cm)	meters (m)		100.0		centimeter (cm)
cubic inch (in <sup>3</sup> )		264.17		cubic foot (ft <sup>3</sup> )	meters (m)		1760.0		yards (yd)
cubic meter (m <sup>3</sup> )		0.00018939		gallons (gal)	miles (mi)		5280.0		feet (ft)
cubic meter (m <sup>3</sup> )		0.33333		miles (mi)	miles (mi)		1.6093		kilometer (km)
cubic meter (m <sup>3</sup> )		12		yards (yd)	miles (mi)		0.0032808		feet (ft)
feet (ft)		0.00030480		inches (in)	millimeters (mm)		0.03937		inch (in)
feet (ft)		0.30480		kilometer (km)	millimeters (mm)		0.001		meters (m)
feet (ft)		30.480		meters (m)	millimeters (mm)		0.01		centimeters (cm)
feet (ft)		304.80		centimeters (cm)	millimeters (mm)		39.3701		mils
feet (ft)		0.00067197		millimeters (mm)	millimeters (mm)		1000.0		microns (μ)
feet (ft)		0.001285		meters/grams (m/g)	millimeters (mm)		44.25		ft-lb/minute
feet (ft)		1.356		British Thermal Unit (BTU)	watts (w)		0.737562		ft-lb/sec
feet/pound (ft/lb)		0.1383		joules (j)	watts (w)		0.001341		horsepower
foot-pound (ft-lb)				kilogram/meter (kg/m)	watts (w)		3.414462		British Thermal Unit (BTU)
foot-pound (ft-lb)					watt-hours (w-hr)				
foot-pound (ft-lb)									

# Temperature Conversion Chart

To use this chart, find your known temperature (°F) in the shaded column.

°C	°F	°C	°F	°C	°F	°C	°F	°C	°F
-45.0	-49.0	-17.2	1.0	10.6	51.0	38.3	101.0	66.1	151.0
-44.4	-48.0	-16.7	2.0	11.1	52.0	38.9	102.0	66.7	152.0
-43.9	-47.0	-16.1	3.0	11.7	53.0	39.4	103.0	67.2	153.0
-43.3	-46.0	-15.6	4.0	12.2	54.0	40.0	104.0	67.8	154.0
-42.8	-45.0	-15.0	5.0	12.8	55.0	40.6	105.0	68.3	155.0
-42.2	-44.0	-14.4	6.0	13.3	56.0	41.1	106.0	68.9	156.0
-41.7	-43.0	-13.9	7.0	13.9	57.0	41.7	107.0	69.4	157.0
-41.1	-42.0	-13.3	8.0	14.4	58.0	42.2	108.0	70.0	158.0
-40.6	-41.0	-12.8	9.0	15.0	59.0	42.8	109.0	70.6	159.0
-40.0	-40.0	-12.2	10.0	15.6	60.0	43.3	110.0	71.1	160.0
-39.4	-39.0	-11.7	11.0	16.1	61.0	43.9	111.0	71.7	161.0
-38.9	-38.0	-11.1	12.0	16.7	62.0	44.4	112.0	72.2	162.0
-38.3	-37.0	-10.6	13.0	17.2	63.0	45.0	113.0	72.8	163.0
-37.8	-36.0	-10.0	14.0	17.8	64.0	45.6	114.0	73.3	164.0
-37.2	-35.0	-9.4	15.0	18.3	65.0	46.1	115.0	73.9	165.0
-36.7	-34.0	-8.9	16.0	18.9	66.0	46.7	116.0	74.4	166.0
-36.1	-33.0	-8.3	17.0	19.4	67.0	47.2	117.0	75.0	167.0
-35.6	-32.0	-7.8	18.0	20.0	68.0	47.8	118.0	75.6	168.0
-35.0	-31.0	-7.2	19.0	20.6	69.0	48.3	119.0	76.1	169.0
-34.4	-30.0	-6.7	20.0	21.1	70.0	48.9	120.0	76.7	170.0
-33.9	-29.0	-6.1	21.0	21.7	71.0	49.4	121.0	77.2	171.0
-33.3	-28.0	-5.6	22.0	22.2	72.0	50.0	122.0	77.8	172.0
-32.8	-27.0	-5.0	23.0	22.8	73.0	50.6	123.0	78.3	173.0
-32.2	-26.0	-4.4	24.0	23.3	74.0	51.1	124.0	78.9	174.0
-31.7	-25.0	-3.9	25.0	23.9	75.0	51.7	125.0	79.4	175.0
-31.1	-24.0	-3.3	26.0	24.4	76.0	52.2	126.0	80.0	176.0
-30.6	-23.0	-2.8	27.0	25.0	77.0	52.8	127.0	80.6	177.0
-30.0	-22.0	-2.2	28.0	25.6	78.0	53.3	128.0	81.1	178.0
-29.4	-21.0	-1.7	29.0	26.1	79.0	53.9	129.0	81.7	179.0
-28.9	-20.0	-1.1	30.0	26.7	80.0	54.4	130.0	82.2	180.0
-28.3	-19.0	-0.6	31.0	27.2	81.0	55.0	131.0	82.8	181.0
-27.8	-18.0	0.0	32.0	27.8	82.0	55.6	132.0	83.3	182.0
-27.2	-17.0	0.6	33.0	28.3	83.0	56.1	133.0	83.9	183.0
-26.7	-16.0	1.1	34.0	28.9	84.0	56.7	134.0	84.4	184.0
-26.1	-15.0	1.7	35.0	29.4	85.0	57.2	135.0	85.0	185.0
-25.6	-14.0	2.2	36.0	30.0	86.0	57.8	136.0	85.6	186.0
-25.0	-13.0	2.8	37.0	30.6	87.0	58.3	137.0	86.1	187.0
-24.4	-12.0	3.3	38.0	31.1	88.0	58.9	138.0	86.7	188.0
-23.9	-11.0	3.9	39.0	31.7	89.0	59.4	139.0	87.2	189.0
-23.3	-10.0	4.4	40.0	32.2	90.0	60.0	140.0	87.8	190.0
-22.8	-9.0	5.0	41.0	32.8	91.0	60.6	141.0	88.3	191.0
-22.2	-8.0	5.6	42.0	33.3	92.0	61.1	142.0	88.9	192.0
-21.7	-7.0	6.1	43.0	33.9	93.0	61.7	143.0	89.4	193.0
-21.1	-6.0	6.7	44.0	34.4	94.0	62.2	144.0	90.0	194.0
-20.6	-5.0	7.2	45.0	35.0	95.0	62.8	145.0	90.6	195.0
-20.0	-4.0	7.8	46.0	35.6	96.0	63.3	146.0	91.1	196.0
-19.4	-3.0	8.3	47.0	36.1	97.0	63.9	147.0	91.7	197.0
-18.9	-2.0	8.9	48.0	36.7	98.0	64.4	148.0	92.2	198.0
-18.3	-1.0	9.4	49.0	37.2	99.0	65.0	149.0	92.8	199.0
-17.8	0.0	10.0	50.0	37.8	100.0	65.6	150.0	93.3	200.0

**TEMPERATURE CONVERSION FORMULA**

$$^{\circ}\text{C} = \frac{5}{9} (^{\circ}\text{F} - 32)$$

$$^{\circ}\text{F} = \frac{9}{5} ^{\circ}\text{C} + 32$$



# Conduit Capacity Chart

Conduit Trade Size	1/2	3/4	1	1 1/4	1 1/2	2	2 1/2	3	3 1/2	4	
I.D. Inches	0.622	0.824	1.049	1.380	1.610	2.067	2.731	3.356	3.834	4.334	
Internal Area, In <sup>2</sup>	0.304	0.533	0.864	1.496	2.036	3.356	5.858	8.846	11.545	14.753	
1 Conductor (53% fill)	0.161	0.283	0.458	0.793	1.079	1.778	3.105	4.688	6.119	7.819	
2 Conductors (31% fill)	0.094	0.165	0.268	0.464	0.631	1.040	1.816	2.742	3.579	4.573	
Conductors (40% fill)	0.122	0.213	0.346	0.598	0.814	1.342	2.343	3.538	4.618	5.901	
Cable OD Inches	Cable Area In <sup>2</sup>	Numbers listed below are based on the 2008 NEC (40% fill ) for 3 or more non-lead covered cables.									
0.100	0.008	15	26	43	76	104	170	244	375	504	648
0.125	0.012	9	17	27	48	66	109	156	240	322	414
0.150	0.018	6	11	19	33	46	75	108	166	224	288
0.175	0.024	5	8	14	24	34	55	79	122	164	211
0.200	0.031	3	6	10	19	26	42	81	93	126	162
0.225	0.040	3	5	8	15	20	33	48	74	99	128
0.250	0.049	1	4	6	12	16	27	39	60	80	103
0.275	0.059	1	3	5	10	13	22	32	49	66	85
0.300	0.071	1	2	4	8	11	18	27	41	56	72
0.325	0.083	1	1	4	7	9	16	23	35	47	61
0.350	0.096	1	1	3	6	8	13	19	30	41	52
0.375	0.110	1	1	3	5	7	12	17	26	35	46
0.400	0.126	1	1	2	4	6	10	15	23	31	40
0.425	0.142	1	1	1	4	5	9	13	20	27	35
0.450	0.159	1	1	1	3	5	8	12	18	24	32
0.475	0.177	0	1	1	3	4	7	10	17	22	28
0.500	0.196	0	1	1	3	4	6	9	15	20	25
0.525	0.216	0	1	1	2	3	6	8	13	18	23
0.550	0.238	0	1	1	1	3	5	8	12	16	21
0.575	0.260	0	1	1	1	3	5	7	11	15	19
0.600	0.283	0	0	1	1	2	4	6	10	14	18
0.625	0.307	0	0	1	1	2	4	6	9	12	16
0.650	0.332	0	0	1	1	1	4	5	8	11	15
0.675	0.358	0	0	1	1	1	3	5	8	11	14
0.700	0.385	0	0	1	1	1	3	5	7	10	13
0.725	0.413	0	0	1	1	1	3	4	7	9	12
0.750	0.442	0	0	1	1	1	3	4	6	8	11
0.775	0.472	0	0	0	1	1	2	4	6	8	10
0.800	0.503	0	0	0	1	1	2	3	5	7	10
0.825	0.535	0	0	0	1	1	1	3	5	7	9
0.850	0.567	0	0	0	1	1	1	3	5	6	8
0.875	0.601	0	0	0	1	1	1	3	4	6	8
0.900	0.636	0	0	0	1	1	1	3	4	6	8
0.925	0.672	0	0	0	1	1	1	2	4	5	7
0.950	0.709	0	0	0	1	1	1	2	4	5	7
0.975	0.747	0	0	0	1	1	1	1	3	5	6
1.000	0.785	0	0	0	1	1	1	1	3	5	6
1.025	0.825	0	0	0	0	1	1	1	3	4	6
1.050	0.866	0	0	0	0	1	1	1	3	4	5
1.075	0.908	0	0	0	0	1	1	1	3	4	5

Notice: 1. The reader is cautioned to consult the NEC for specific information regarding conduit fill.  
 2. This Conduit Capacity Chart should only be used as a guide when attempting to estimate conduit fill.  
 3. For additional information, the reader should refer to the National Electrical Code.







# Glossary

- Abrasion Resistance:** Resistance to surface wear.
- AC Alternating Current (a.c.):** Current in which the charge-flow periodically reverses and is represented by:  $I = I_G \cos(2\pi f - t)$  where,  $I$  is the current,  $I_G$  is the amplitude,  $f$  the frequency,  $t$  the phase angle.
- Accelerated Aging:** A test that attempts to duplicate long-time environmental aging in comparatively short time spans.
- Accelerator:** A chemical additive which hastens a chemical reaction under specific conditions.
- Accordion:** (1) A retractile cable with a series of equally-spaced transverse folds. (2) A connector contact with a "Z" shaped flat spring to permit high deflection without overstress.
- Adapter:** A device that enables any or all of the following 1) different sizes or types of plugs to mate with one another or to fit into a telecommunications outlet/connector; 2) the rearrangement of leads; 3) large cables with numerous wires to fan out into smaller groups of wires, 4) interconnection between cables.
- Adhesive Bonded:** Cables bonded by adding an adhesive coating to the surface of the cable components, then joining and curing the adhesive to form a cable. See Bonded Cable.
- Administration:** The method for labeling, identification, documentation and usage needed to implement moves, additions and changes of the telecommunications infrastructure.
- Admittance:** The measure of the ease with which an alternating current flows in a circuit. The reciprocal of impedance.
- Aerial Cable:** A cable suspended in the air on poles or other overhead structure.
- Aging:** The change in properties of a material with time under specific conditions.
- Air Core Cable:** A cable in which the interstices in the cable core are not filled with a moisture barrier.
- Air-Handling Plenum:** A designated area, closed or open, used for environmental air.
- Air Spaced Coaxial Cable:** One in which air is essentially the dielectric material. A spirally wound synthetic filament, beads or braided filaments may be used to center the conductor.
- All-Rubber Cable:** A cable in which all interstices between conductors are filled with rubber compound.
- Alligator Clip:** A mechanical device shaped like alligator jaws used as a temporary connection on the end of interconnections wire.
- Alloy:** A metal formed by combining two or more different metals to obtain desirable properties.
- Aluminum Conductor:** An aluminum wire or group of wires not suitably insulated to carry electrical current.
- Aluminum-Steel Conductor:** A composite conductor made up of a combination of aluminum and steel wires.
- Ambient Temperature:** The temperature of a medium (gas or liquid) surrounding an object.
- American Wire Gauge (AWG):** The standard system used for designating wire diameter. The lower the AWG number, the larger the diameter. Also called the Brown and Sharpe (B&S) wire gauges.
- Ampacity:** See Current Carrying Capacity.
- Ampere:** The unit of current. One ampere is the current flowing through one ohm of resistance at one volt potential.
- Analog:** A signaling format that uses continuous physical variables such as voltage amplitude or frequency variations to transmit information.
- Anneal:** Relief of mechanical stress through heat and gradual cooling. Annealing copper renders it less brittle.
- Annular Conductor:** A number of wires stranded in three reversed concentric layers around a core.
- Annunciator:** A signaling device, usually electrically operated, that gives an audible or visual signal (or both) when energized.
- Anti-Oxidant:** A substance which prevents or slows down oxidation of material exposed to air.
- Appliance Wire and Cable:** A classification covering insulated wire and cable for internal wiring of appliances and equipment.
- Arc Resistance:** The time required for an arc to establish a conductive path in a material.
- Armored Cable:** A cable provided with a wrapping of metal for mechanical protection.
- Attenuation:** The decrease in magnitude of the power of a signal in transmission between points. Attenuation is usually measured in decibels per unit length at a specific frequency.
- Attenuation to Crosstalk Ratio (ACR):** The difference between attenuation and crosstalk, measured in dB, at a given frequency. Important characteristic in networking transmission to assure that signal sent down a twisted pair is stronger at the receiving end, after being attenuated, than are any interference signals imposed on that same pair by crosstalk from other pairs, represented by NEXT.
- Audio Frequency:** The range of frequencies audible to the human ear. Usually 20-20,000 Hz.
- Backbone:** A facility (e.g. pathway, cable or conductors) between telecommunications closets or floor distribution terminals, the entrance facilities and the equipment rooms within or between buildings.
- Backbone Cable or Wire:** Cable or wire found in the backbone; see Backbone.
- Balanced Line:** A cable having two identical conductors which carry voltages opposite in polarity and equal in magnitude with respect to ground.
- Balun:** A device for matching an unbalanced coaxial transmission line to a balanced two-wire system.
- Band Marking:** A continuous circumferential band applied to a conductor at regular intervals for identification.
- Banded Cable:** Two or more cables banded together by stainless steel strapping.
- Bandwidth:** A continuous range of frequencies extending between two limiting frequencies. Also referred to as a frequency band.
- Barrel-Packed:** Method of coiling into a fiber drum for shipment.
- Baseband:** In data transmission, the use of a dedicated end-to-end connection to carry a single channel only.
- Beaded Coax:** Coaxial cable with a dielectric consisting of beads made of various materials.
- Belt:** Number of layers of insulation on a conductor, or number of layers of jacket on a cable.
- Belted-Type Cable:** Multiple conductor cable having a layer of insulation over the assembled insulated conductors.
- Bend Loss:** A form of increased attenuation caused by (1) having an optical fiber curved around a restrictive radius of curvature or (2) microbends caused by minute distortions in the fiber imposed by externally induced forces.
- Bend Radius:** Radius of curvature that a fiber optic or metallic cable can bend without any adverse effects.
- Bifilar:** A winding made non-inductive by winding together (as one wire) two wires carrying current in opposite directions.
- Billion Conductor Feet (BCF):** A quantity derived by multiplying the number of conductors in a cable by the amount of cable. Usually used to indicate plant capacity or an annual requirement.
- Bimetallic Wire:** A wire formed of two different metals joined together (not alloyed). It can include wire with a steel core clad wire, or plated or coated wire.
- Binder:** A spirally served tape or thread used for holding assembled cable components in place awaiting subsequent manufacturing operations.
- Binding Post:** A device for clamping or holding electrical conductors in a rigid position.
- Bit:** One binary (0 or 1) digit.
- Blown Jacket:** Outer cable covering applied by controlled inflation of the cured jacket tube then pulling the cable through it.
- Bond Strength:** Amount of adhesion between bonded surfaces, e.g. in cemented ribbon cable.
- Bondable Wire:** An insulated wire treated to facilitate adherence to materials such as potting compounds. Also, magnet wires used in making coils when bonding the turns together is desired.
- Bonded Cable:** Cable consisting of pre-insulated conductors or multiconductor components laid-in parallel and bonded into a flat cable. See Solvent-Bonded; Adhesive-Bonded; Film-Bonded.
- Bonded Construction:** An insulation construction in which the glass braid and nylon jacket are bonded together.
- Bonding:** The permanent joining of metallic parts to form an electrically conductive path that will assure electrical continuity and the capacity to conduct safely any current likely to be imposed on it.
- Booster:** A device inserted into a line (or cable) to increase the voltage.
- Boot:** (1) Protective covering over a cable, wire or connector in addition to the normal jacketing or insulation. (2) A form placed around wire termination of a multiple-contact connector to contain the liquid potting compound before it hardens.
- Braid:** A fibrous or metallic group of filaments interwoven in cylindrical form to form a covering over one or more wires.
- Braid Angle:** The smaller of the two angles formed by the shielding strand and in the axis of the cable being shielded.
- Braid Carrier:** A spool or bobbin on a braid which holds one group of strands or filaments consisting of a specific number of ends. The carrier revolves during braiding operations.
- Braid Ends:** The number of strands used to make up one carrier. The strands are wound side by side on the carrier bobbin and lie parallel in the finished braid.

# Glossary

**Braiding Machine:** Machine used to apply braids to wire and cable and to produce braided sleeving and braids for tying or lacing purposes. Braiding machines are identified by the number of carriers.

**Breakdown (Puncture):** A disruptive discharge through the insulation.

**Breakdown Voltage:** The voltage at which the insulation between two conductors breaks down.

**Breakout:** The point at which a conductor or group of conductors breaks out from a multiconductor cable to complete circuits at various points along the main cable.

**Bridge:** A device used to expand a local area network by forwarding frames between data link layers.

**Bridged Tap:** The multiple appearances of the same cable pair at several distribution points.

**British Standard Wire Gauge:** A modification of the Birmingham Wire Gauge and the legal standard of Great Britain for all wires. Also known as Standard Wire Gauge (SWG), New British Standard (NBS), English Legal Standard and Imperial Wire Guide.

**Broadband:** In data transmission, the use of a carrier signal, rather than direct modulation, to carry several simultaneous channels.

**Buffer:** (fiber optic) A soft material which mechanically isolates individual fibers in a fiber optic cable or bundle from small geometrical irregularities, distortions or roughness of adjacent surfaces.

**Buffing Stripper:** A motorized device for removing flat cable insulation by means of buffing wheels that melt the insulation and brush it away from the conductors. Also called Abrasion Stripper.

**Building Entrance Area:** See Entrance Room or Space, Telecommunications.

**Building Wire:** Wire used for light and power, 600 volts or less, usually not exposed to outdoor environment.

**Bunched Stranding:** A group of strands twisted together in a random manner and the same direction without regard to geometric arrangement of specific strands.

**Buncher:** A machine that twists wires together in random arrangement.

**Bundle:** (fiber optic) A number of fibers grouped together, usually carrying a common signal.

**Buried Cable:** A cable installed directly in the earth without use of underground conduit. Also called "direct burial cable."

**Bus:** Wire used to connect two terminals inside of an electrical unit.

**Bushing:** A mechanical device used as a lining for an opening to prevent abrasion to wire and cable.

**Butt:** Joining of two conductors end-to-end, with no overlap and with the axes in line.

**Butt Splice:** A splice wherein two wires from opposite ends butt against each other, or against a stop, in the center of a splice.

**Butt Wrap:** Tape wrapped around an object or conductor in an edge-to-edge condition.

**Byte:** Typically a group of eight binary digits.

**Cable:** A stranded conductor with or without insulation and other coverings (single-conductor cable), or a combination of conductors (multiple-conductor cable). In fiber optics, a jacketed fiber or jacketed bundle in a form which can be terminated.

**Cable Assembly:** Typically, the cable and associated connectors; ready to install.

**Cable Clamp:** A device used to give mechanical support to the wire bundle or cable at the rear of a plug or receptacle.

**Cable Clamp Adapter:** A mechanical adapter that attaches to the rear of a plug or receptacle to allow the attachment of a cable clamp.

**Cable Core:** The portion of an insulated cable lying under a protective covering.

**Cable Core Binder:** A wrapping of tapes or cords around the conductors of a multiple-conductor cable used to hold them together.

**Cable Filler:** The material used in multiple-conductor cables to occupy the interslices formed by the assembly of the insulated conductors, thus forming a cable core.

**Cable Rack:** The vertical or horizontal open support (usually made of aluminum or steel) that is attached to a ceiling or wall.

**Cable Sheath:** The overall protective covering applied to cables.

**Cable Tray:** A ladder, trough, solid-bottom or channel raceway system intended for, but not limited to, the support of telecommunications media (e.g., cable).

**Cable Vulcanizer:** Compression molding machine used to repair cable jacketing that has had a part removed for splicing, for adding connectors or other devices or for replacing damaged sections.

**Cabling:** (1) A combination of all cables, wire, cords and connecting hardware. (2) Twisting together two or more insulated conductors by machine to form a cable. In fiber optics, a method by which a group or bundle of fibers is mechanically assembled.

**Cabling Factor:** Used in the formula for calculating the diameter of an unshielded, unjacketed cable.  $D = Kd$ , where  $D$  is the cable diameter,  $K$  is the factor and  $d$  is the diameter of one insulated conductor.

**Campus:** The building and grounds of a complex (e.g. a university, college, industrial park or military establishment).

**Canadian Standards Association (CSA):** A non-profit independent organization which operates a listing service for electrical and electronic materials and equipment. The Canadian counterpart of the Underwriter's Laboratories.

**Capacitance:** The ratio of the electrostatic charge on a conductor to the potential difference between the conductors required to maintain that charge.

**Capacitance, Direct:** The capacitance measured from one conductor to another conductor through a single insulating layer.

**Capacitance, Mutual:** The capacitance between two conductors (typically of a pair) with all other conductors, including shield, short circuited to ground.

**Carolprene®:** Proprietary rubber compound.

**Carrier:** The woven element of a braid consisting of one or more ends (strands) which creates the interlaced effect. Also, a spindle, spool, tube, or bobbin (on a braiding machine) containing yarn or wire, employed as a braid.

**Cellular Plastics:** Expanded or "foam," consists of individual closed cells of inert gas suspended in a plastic medium, resulting in a desirable reduction of the dielectric constant.

**Central Office:** The place where communications common carriers terminate customer lines and locate switching equipment that interconnects those lines.

**Certificate of Compliance (C of C):** A written statement; normally generated by a quality control department, which states that the product being shipped meets customer's specifications.

**Certified Test Report (CTR):** A report reflecting actual test data on the cable shipped. Tests are normally conducted by the quality control department, and show that the product being shipped meets the required test specifications.

**Characteristic Impedance:** The impedance that, when connected to the output terminals of a transmission line of any length, makes the line appear indefinitely long.

**Chlorosulfonated Polyethylene (CSPE):** A rubbery polymer used for insulations and jackets. Manufactured by E.I. DuPont under the trade name of Hypalon®.

**Cigarette Wrap:** Tape insulation wrapped longitudinally instead of spirally over a conductor.

**Circuit:** A complete path over which electrons can flow from the negative terminals of a voltage source through parts and wires to the positive terminals of the same voltage source.

**Circuit Sizes:** A popular term for building wire sizes 14 through 10 AWG.

**Circular Mil:** The area of a circle one mil (.001") in diameter;  $7.854 \times 10^{-7}$  sq. in. Used in expressing wire cross sectional area.

**Cladding:** Method of applying a layer of metal over another metal whereby the junction of the two metals is continuously welded. In fiber optics, a sheathing intimately in contact with the core of a higher refractive index material which serves to provide optical insulation and protection to the reflection interface.

**Closed End Splice:** An insulated splice in which two or more wires overlap and enter the splice from the same end of the barrel.

**Closet, Telecommunications:** An enclosed space for housing telecommunications equipment, cable terminations and cross-connect cabling. The closet is the recognized location of the cross-connect between the backbone and horizontal facilities.

**Coaxial Cable:** A cable consisting of two cylindrical conductors with a common axis, separated by a dielectric.

**Coaxial Connector:** A connector that has a coaxial construction and is used with coaxial cable.

**Coherent Source:** (fiber optic) A light source which emits a very narrow, unidirectional beam of light of one wavelength (monochromatic).

**Coil Effect:** The inductive effect exhibited by a spiral-wrapped shield, especially above audio frequencies.

**Cold Flow:** Permanent deformation of the insulation due to mechanical force of pressure (not due to heat softening).

**Color Code:** A color system for wire or circuit identification by use of solid colors, tracers, braids, surface printing, etc.

**Commercial Building:** A building or portion thereof, that is intended for office use.

# Glossary

- Common Axis Cabling:** In multiple cable constructions, a twisting of all conductors about a "common axis" to result in smaller diameter constructions. Tends to result in greater susceptibility to electromagnetic and electrostatic interference.
- Compact Conductor:** Stranded conductor rolled to deform the round wires to fill the normal interstices between the wires in a strand.
- Composite (Clad) Wire:** A wire having a core of one metal with a fused outer shell of different metals.
- Composite Conductor:** Two or more strands of different metals assembled and operated in parallel.
- Compound:** An insulating or jacketing material made by mixing two or more ingredients.
- Compression Cable:** A pipe type cable in which the pressure medium is separated from the insulation by a membrane or sheath.
- Concentric:** A central core surrounded by one or more layers of helically wound strands in a fixed round geometric arrangement.
- Concentric-Lay Cable:** A concentric-lay conductor, or a multiple-conductor cable composed of a central core surrounded by one or more layers of helically laid insulated conductors.
- Concentric Strand:** A strand that consists of a central wire or core surrounded by one or more layers of spirally laid wires.
- Concentricity:** The measurement of the location of the center of the conductor with respect to the geometric center of the circular insulation.
- Conductance:** The ability of a conductor to carry an electric charge. The ratio of the current flow to the potential difference causing the flow. The reciprocal of resistance.
- Conductivity:** The capacity of a material to carry electrical current—usually expressed as a percentage of copper conductivity (copper being 100%).
- Conductor:** A wire (or combination of wires not insulated from one another) suitable for carrying electric current.
- Conduit:** A rigid or flexible metallic or nonmetallic raceway of circular cross-section through which cables can be pulled or housed.
- Connecting Hardware:** A device providing mechanical cable terminations.
- Connector:** A device used to provide rapid connect/disconnect service for electrical cable and wire terminations.
- Contact:** The part of a connector which actually carries the electrical current, and are touched together or separated to control the flow.
- Contact Inspection Hole:** A hole in the cylindrical rear portion of contact used to check the depth to which a wire has been inserted.
- Contact Size:** The largest size wire which can be used with the specific contact. Also, the diameter of the engagement end of the pin.
- Continuity Check:** A test to determine whether electrical current flows continuously throughout the length of a single wire or individual wires in a cable.
- Continuous Vulcanization:** Simultaneous extrusion and vulcanization of rubber-like wire coating materials.
- Contra-helical:** Cable spiralling in an opposite direction than the preceding layer within a wire or cable.
- Control Cable:** A multi-conductor cable made for operation in control of signal circuits.
- Controlled Impedance Cable:** Package of two or more insulated conductors where impedance measurements between respective conductors are kept essentially constant throughout the entire length.
- Copolymer:** A compound resulting from the polymerization of two different monomers.
- Copper-Clad:** Steel with a coating of copper welded to it before drawing as opposed to copper-plated. Synonymous with Copperweld.
- Copperweld:** The trade name of Flexo Wire Division (Copperweld Steel Corp.) for their copper-clad steel conductors.
- Cord:** A small, flexible insulated cable.
- Cord Set:** Portable cords fitted with a wiring device at one or both ends.
- Cord, Telecommunications:** A cable using stranded conductors for flexibility, as in distribution cords or line cords. Line cords can also use tinsel conductors.
- Core:** In cables, a component or assembly of components over which other materials are applied, such as additional components, shield, sheath or armor. In fiber optics, the transparent glass or plastic section with a high refractive index through which the light travels by internal reflections.
- Corona:** A discharge due to ionization of air around a conductor due to a potential gradient exceeding a certain critical value.
- Corona Resistance:** The time that the insulation will withstand a specified level of field-intensified ionization that does not result in the immediate complete breakdown of the insulation.
- Corrosion:** The destruction of the surface of a metal by chemical reaction.
- Coupling Loss:** (fiber optic) Signal losses due to small differences in numerical aperture, core diameter, core concentricity and tolerances in splicing connectors when two fibers are aligned. Also known as Splicing Loss and Transfer Loss.
- Coupling Ring:** A device used on cylindrical connectors to lock plug and receptacle together.
- Coverage:** The calculated percentage which defines the completeness with which a metal braid covers the underlying surface. The higher percentage of coverage, the greater the protection against external interference.
- Covering:** Textile braid or jacket of rubber, plastics or other materials applied over wire and cables to provide mechanical protection and identification.
- Crazing:** The minute cracks on the surface of plastic materials.
- Creep:** The dimensional change with time of a material under load.
- Creepage:** The conduction of electricity across the surface of a dielectric.
- Creepage Path:** The path across the surface of a dielectric between two conductors.
- Creepage Surface:** An insulating surface which provides physical separation as a form of insulation between two electrical conductors of different potential.
- Crimp:** Act of compressing a connector barrel around a cable in order to make an electrical connection.
- Crimp Termination:** Connection in which a metal sleeve is secured to a conductor by mechanically crimping the sleeve with pliers, presses or automated crimping machines.
- Cross-Connect:** A facility enabling the termination of cable elements and their interconnection, and/or cross-connection, primarily by means of a patch cord or jumper.
- Cross-Linked:** Inter-molecular bonds between long-chain thermoplastic polymers by chemical or electron bombardment means. The properties of the resulting thermosetting material are usually improved.
- Crosstalk:** Undesired electrical currents in conductors caused by electromagnetic or electrostatic coupling from other conductors or from external sources. Also, leakage of optical power from one optical conductor to another.
- CSA:** Canadian Standards Association.
- C-SJ:** Same as SJ except extra-flexible conductor.
- C-SJO:** Same as SJO except extra-flexible conductor.
- Cure:** To change the physical properties of a material by chemical reaction.
- Curing Cycle:** The time, temperature and pressure required for curing.
- Curl:** The degree to which a wire tends to form a circle after removal from a spool. An indication of the ability of the wire to be wrapped around posts in long runs.
- Current:** The rate of transfer of electricity. Practical unit is the ampere which represents the transfer of one coulomb per second. In a simple circuit, current (I) produced by a cell or electromotive force (E) when there is an external resistance (R) and internal resistance (r) is:  

$$I = \frac{E}{R+r}$$
- Current Carrying Capacity:** The maximum current an insulated conductor can safely carry without exceeding its insulation and jacket temperature limitations.
- Customer Premises:** Building(s) with grounds and appurtenances (belongings) under the control of the customer.
- Cut-Through Resistance:** The ability of a material to withstand mechanical pressure, usually a sharp edge or small radius, without separation.
- Cycle:** The complete sequence including reversal of the flow of an alternating electric current.
- Decibel (dB):** A unit to express differences of power level. Used to express power gain in amplifiers or power loss in passive circuits or cables.
- Delay Line:** A cable made to provide very low velocity of propagation with long electrical delay for transmitted signals.
- Demarcation Point:** A point where the operational control or ownership changes.
- Depth of Crimp:** Thickness of the crimped portion of a connector measured between two opposite points on the crimped surface.
- Derating Factor:** A factor used to reduce the current carrying capacity of a wire when used in environments other than that for which the value was established.
- Detector:** (fiber optic) A device that picks up light from fiber and converts the information into an electrical signal.
- Device, As Related to a Work Station:** An item such as a telephone, personal computer or graphic or video terminal.

# Glossary

- Device, As Related to Protection:** A protector, a protector mount, a protector unit or a protector module.
- Dielectric:** An insulating medium which intervenes between two conductors and permits electrostatic attraction and repulsion to take place across it.
- Dielectric Breakdown:** The voltage required to cause an electrical failure or breakthrough of the insulation.
- Dielectric Constant (K):** The ratio of the capacitance of a condenser with dielectric between the electrodes to the capacitance when air is between the electrodes. Also called Permittivity and Specific Inductive Capacity.
- Dielectric Loss:** Power dissipated in an insulating medium as the result of the friction caused by molecular motion when an AC electric field is applied.
- Dielectric Strength:** The voltage which an insulation can withstand before breakdown occurs. Usually expressed as a voltage gradient (such as volts per mil).
- Dielectric Test:** A test in which a voltage higher than the rated voltage is applied for a specified time to determine the adequacy of the insulation under normal conditions.
- Digital:** Transmission data representative by discrete characters.
- Dip Coating:** An insulating coating applied to the conductor by passing the conductor through an applicator containing liquid insulating medium.
- Direct Burial Cable:** A cable installed directly in the earth.
- Direct Capacitance:** The capacitance measured directly from conductor to conductor through a single insulating layer.
- Direct Current (d.c.):** An electric current which flows in only one direction.
- Direct Current Resistance (DCR):** The resistance offered by any circuit to the flow of direct current.
- Direction of Lay:** The lateral direction in which the strands of a conductor run over the top of the cable conductor as they recede from an observer looking along the axis of the conductor or cable. Also applies to twisted cable.
- Discrete Wiring:** Wire or wires having distinct identity and purpose.
- Dispersion:** (fiber optic) The variation of the refractive index of a material with wavelength, causing light of different wavelengths to travel at different velocities in the material.
- Disruptive Discharge:** A sudden, large increase in current through an insulation medium due to the complete failure of the medium under the electrostatic stress.
- Dissipation Factor:** The tangent of the loss angle of the insulating material. (Also referred to as loss tangent,  $\tan \delta$ , and approximate power factor.)
- Distribution Cable:** In telecommunications and CATV systems, the transmission cable between the distribution amplifier and the drop wire.
- Distribution Frame:** A structure with terminations for connecting the permanent cabling of a facility in such a manner that interconnection or cross-connections may be readily made.
- Disturbed Conductor:** A conductor that receives energy generated by the field of another conductor or an external source such as a transformer.
- Drain Wire:** In a cable, the uninsulated wire laid over the component or components and used as a ground connection.
- Draw Feed Stock:** Rod or wire that is subsequently drawn to a smaller size.
- Drawing:** In wire manufacture, pulling the metal through a die or series of dies to reduce diameter to a specified size.
- Drop Ceiling:** See False Ceiling.
- Drop Wire:** In telecommunications and CATV systems, the transmission cable from the distribution cable to a dwelling.
- Dual Coaxial Cable:** Two individually insulated conductors laid parallel or twisted and placed within an overall shield and sheath.
- Duct:** 1) A single enclosed raceway for wires or cables. See also Conduit, Raceway; 2) a single enclosed raceway for wires or cables usually used in soil or concrete; 3) an enclosure in which air is moved. Generally part of the HVAC system of a building.
- Duplex:** Two way data transmission on a four-wire transmission line or two fiber.
- Duplex Cable:** (1) A cable composed of two insulated single-conductor cables twisted together. (2) A cable composed of two fibers, typically 62.5/125 mm multimode, placed in parallel under a thermoplastic sheath.
- Duplex Parallel:** Typically used in the thermocouple industry to denote two parallel conductors of dissimilar metals insulated in parallel without twist and jacketed. Commonly applied to thermocouple grades and extension wires.
- Eccentricity:** Like concentricity, a measure of the center of a conductor's location with respect to the circular cross section of the insulation. Expressed as a percentage of displacement of one circle within the other.
- Eddy Current:** Circulating currents induced in conducting materials by varying magnetic fields.
- Elastomer:** A rubber or rubber-like material which will stretch repeatedly to 200 percent or more and return rapidly and with force to its approximate original shape.
- Electro-Tinned:** Electrolytic process of tinning wire using pure tin.
- Electrode:** A conductor through which a current enters or leaves a nonmetallic conductor.
- Electromagnetic Coupling:** Energy transfer by means of a varying magnetic field.
- Electromagnetic Field:** A rapidly moving electric field and its associated moving magnetic field.
- Electromagnetic Induction:** The production of a voltage in a coil due to a change in the number of magnetic lines of forces (flux linkages) passing through the coil.
- Electromagnetic Interference (EMI):** The interference in signal transmission or reception resulting from the radiation of electrical and magnetic fields. Synonym: Radio Frequency Interference.
- Electromotive Force (e.m.f.):** Pressure or voltage. The forces which cause current to flow in a circuit.
- Electronic Wire and Cable:** A length of conductive or semiconductive material used in an electronic application.
- Electrostatic:** Pertaining to static electricity, or electricity at rest. An electric charge, for example.
- Elongation:** The fractional increase in the length of a material stressed in tension.
- Embossing:** A marker identification by means of thermal indentation leaving raised lettering on the sheath material of cable.
- Emergency Overload:** Load which occurs when larger than normal currents are carried through a cable or wire over a certain period of time.
- Enameled Wire:** A conductor with a baked-on enamel film insulation. In addition to magnet wire, enameled insulation is used on thermocouple type wires and other wires.
- Ends:** In braiding, the number of essentially parallel wires of threads on a carrier.
- Energize:** To apply rated voltage to a circuit or device in order to activate it.
- Entrance Facility, Telecommunications:** An entrance to a building for both public and private network service cables (including antennae) including the entrance point at the building wall and continuing to the entrance room or space.
- Entrance Point, Telecommunications:** The point of emergence of telecommunications conductors through an exterior wall, a concrete floor slab or from a rigid metal conduit or intermediate metal conduit.
- Entrance Room or Space, Telecommunications:** A space in which the joining of inter- or intra-building telecommunications backbone facilities takes place. An entrance room may also serve as an equipment room.
- Equilay:** More than one layer of helically laid wires with the direction of lay reversed for successive layers, but with the length of lay the same for each layer.
- Equipment Room, Telecommunications:** A centralized space for telecommunications equipment that serves the occupants of the building. An equipment room is considered distinct from a telecommunications closet because of the nature of complexity or the equipment.
- Etched Wire:** A process applied to fluoroplastic wire in which the wire is passed through a sodium bath to create a rough surface to allow epoxy resin to bond the fluoroplastic.
- Exit Angle:** The angle between the output radiation vectors and the axis of the fiber or fiber bundle.
- External Interference:** The effects of electrical waves or fields which cause sounds other than the desired signal. Static.
- External Wiring:** Electronic wiring which interconnects subsystems within the system.
- Extruded Cable:** Cable with conductors which are uniformly insulated and formed by applying a homogeneous insulation material in a continuous extrusion process.
- Extrusion:** Method of continuously forcing plastic, rubber, or elastomer material through an orifice to apply insulation or jacketing over a conductor or cable core.
- False Ceiling:** A ceiling that creates an area or space between the ceiling material and the structure above the material. Synonym: Drop Ceiling, Suspended Ceiling.
- Farad:** A unit of electrical capacity.
- Fatigue Resistance:** Resistance to metal crystallization which leads to conductors or wires breaking from flexing.
- Feed-Through Insulators:** Insulators that carry a metal conductor through the chassis while preventing the "hot" lead from shorting to the ground chassis.

# Glossary

- Feedback:** Energy that is extracted from a high-level point in a circuit and applied to a lower level. Positive feedback reduces the stability of a device and is used to increase the sensitivity or produce oscillation in a system. Negative feedback, also called inverse feedback, increases the stability of a system as the feedback improves stability and fidelity.
- Feeder Cable:** In telecommunication or CATV systems, the transmission cable from the head end (signal pickup) to the trunk amplifier. Also called a trunk cable.
- Feedthrough:** (1) A conductor that connects patterns on opposite sides of a PCB. Also called Interfacial connection. (2) A connector or terminal block, usually having double-ended terminals which permit simple distribution and bussing of electrical circuits.
- Ferrous:** Composed of and/or containing iron. A ferrous metal exhibits magnetic characteristics.
- Ferrule:** A short tube used to make solderless connections to shielded or coaxial cable.
- Fiber:** A thread or threadlike structure. Also, a single discrete element used to transmit optical (light wave) information.
- Fiber Dispersion:** (fiber optic) Pulse spreading in a fiber caused by differing transit times of various modes.
- Fiber Optics:** A lightwave or optical communications system in which electrical information is converted to light energy, transmitted to another location through optical fibers, and is there converted back into electrical information.
- Fiber Tubing:** A loose, crush-resistant cylinder applied over individual fibers to provide mechanical protection.
- Field:** An area of influence around a magnet or electric charge.
- Field Coil:** A suitable insulated winding to be mounted on a field pole to magnetize it.
- Figure 8 Cable:** An aerial cable configuration in which the conductors and the steel strand which supports the cable are integrally jacketed. A cross-section of the finished cable approximates the figure "eight."
- Filament:** Fiber characterized by extreme length.
- Filled Cable:** A telephone cable construction in which the cable core is filled with a material that will prevent moisture from entering or passing through the cable.
- Filler:** (1) A material used in multiconductor cables to occupy large interstices formed by the assembled conductors. (2) An inert substance added to a compound to improve properties or decrease cost.
- Film:** A thin plastic sheet.
- Fine Stranded Wire:** Stranded wire with component strands of 36 AWG or smaller.
- Firestop:** A material, device or assembly of parts installed in a cable system in a fire-rated wall or floor to prevent passage of flame, smoke or gasses through the rated barrier.
- Flame Resistance:** The ability of a material not to propagate flame once the heat source is removed.
- Flammability:** The measure of the material's ability to support combustion.
- Flashover:** A disruptive discharge around or over the surface of a solid or liquid insulator.
- Flat Braid:** A woven braid of tinned copper strands rolled flat at time of manufacture to a specified width.
- Flat Cable:** A cable with two smooth or corrugated but essentially flat surfaces.
- Flat Conductor:** A wire having a rectangular cross-section as opposed to a round or square conductor.
- Flat Conductor Cable:** A cable with a plurality of flat conductors.
- Flexfoil®:** Proprietary aluminum laminated shielding tapes.
- Flex Life:** The measurement of the ability of a conductor or cable to withstand repeated bending.
- Flexibility:** The ease with which a cable may be bent.
- Flexible:** That quality of a cable or cable component which allows for bending under the influence of outside force, as opposed to limpness which is bending due to the cable's own weight.
- Floating:** Referring to a circuit which has no connection to ground.
- Flux:** (1) The lines of force which make up an electrostatic field. (2) The rate of flow of energy across or through a surface. (3) A substance used to promote or facilitate fusion.
- FNCC:** Federal Networking Council (formerly FRICC).
- Foamed Plastics:** See Cellular Plastic.
- Foil:** A thin, continuous sheet of metal.
- Free Connector:** A connector for attachment to the free end of a wire or cable.
- Frequency:** The number of times a periodic action occurs in a unit of time. The number of cycles that an electric current completes in one second.
- Frequency Response:** The characteristic of a device denoting the range of frequencies over which it may be used effectively.
- Funnel Entry:** Flared or widened entrance to a terminal or connector wire barrel.
- Fuse Wire:** Wire made from an alloy that melts at a relatively low temperature.
- Fused Coating:** A metallic coating which has been melted and solidified, forming a metallurgical bond to the base material.
- Fused Conductors:** Individual strands of heavy tinned copper wire stranded together and then bonded together by induction heating.
- Fused Spiral Tape:** A PTFE insulated hookup wire. The spiral wrapped conductor is passed through a sintering oven where overlaps are fused together.
- Gain:** The increase of voltage, current or power over a standard or previous reading. Usually expressed in decibels.
- Galvanometer:** An instrument for detecting or measuring small electrical current.
- Gas-Filled Cable:** A self-contained pressure cable in which the pressure medium is an inert gas having access to the insulation.
- Gauge:** A term used to denote the physical size of a wire.
- Giga:** A numerical prefix denoting one billion (10<sup>9</sup>).
- Gigahertz (GHz):** A unit of frequency equal to one billion hertz.
- Gimmick:** A short length of wire soldered onto a circuit component and used as a small adjustable capacitor.
- Graded-Index:** A type of optical fiber in which the refractive index of the core is in the form of a parabolic curve, decreasing toward the cladding. This type of fiber provides high bandwidth capabilities.
- Ground:** A conducting connection, whether intentional or accidental, between an electrical circuit (e.g. telecommunications) or equipment and the earth, or to some conducting body that serves in place of the earth.
- Ground Conductor:** A conductor in a transmission cable or line that is grounded.
- Ground Insulation:** The insulation used between a winding and the magnetic core or other structural parts, usually at ground potential.
- Ground Loop:** The generation of undesirable current flow within a ground conductor, owing to the circulation currents which originate from a second source of voltage.
- Ground Plane:** Expanded copper mesh which is laminated into some flat cable constructions as a shield.
- Ground Potential:** Zero potential with respect to the ground or earth.
- Hard Drawn Copper Wire:** Copper wire that has not been annealed after drawing.
- Harness:** An arrangement of wires and cables usually with many breakouts, which have been tied together or pulled into a rubber or plastic sheath, used to interconnect an electric circuit.
- Hash Mark Stripe:** A non-continuous helical stripe applied to a conductor for identification.
- Heat Distortion:** Distortion of flow of a material or configuration due to the application of heat.
- Heat Seal:** Method of sealing a tape wrap jacket by means of thermal fusion.
- Heater Cord:** Flexible stranded copper conductor, cotton wrapped, with rubber insulation and asbestos roving.
- Helical Stripe:** A continuous, colored, spiral stripe applied to a conductor for circuit identification.
- Helix:** Spiral winding.
- Henry:** The unit of inductance.
- Hertz (Hz):** A term replacing cycles-per-second as an indication of frequency.
- Heterogeneous Insulation:** A cable insulating system composed of two or more layers of different insulating materials.
- High-Temperature Wire and Cable:** Electrical wire and cables having thermal operating characteristics of 150°C and higher.
- High Voltage:** Generally, a wire or cable with an operating voltage of over 600 volts.
- Holding Strength:** Ability of a connector to remain assembled to a cable when under tension.
- Homogeneous Insulation:** A complete cable insulation structure whose components cannot be identified as layers of different materials.
- Hook-up Wire:** A wire used for low-current, low-voltage (under 1000 volts) applications within enclosed electronic equipment.
- Horizontal Cabling:** The wiring/cabling between the telecommunications outlet/connector and the horizontal cross-connect.
- Horizontal Cross-Connect:** A cross-connect of horizontal cabling to other cabling, e.g. horizontal, backbone or equipment.
- Hot Stamping:** Method of alpha numerical coding. Identification markings are made by pressing heated type and marking foil into softened insulation surfaces. See Surface Printing.
- Hot Tin Dip:** A process of passing bare wire through a bath of molten tin to provide a coating.
- Hybrid Cable:** An assembly of two or more cables (of the same or different types or categories) covered by one overall sheath.

# Glossary

**Hygroscopic:** Capable of absorbing moisture from the air.

**Hypalon®:** DuPont's trade name for their chlorosulfonated polyethylene, an ozone-resistant synthetic rubber.

**Impact Tool:** Device used to punch new conductor onto IDs. This tool is typically equipped with a cutting blade for either 66 or 110 blocks.

**Impedance:** The total opposition that a circuit offers to the flow of alternating current or any other varying current at a particular frequency. It is a combination of resistance R and reactance X, measured in  $\Omega$ .

**Impedance-Matching Transformer:** A transformer designed to match the impedance of one circuit to that of another (BALUN).

**Impulse:** A surge of unidirectional polarity.

**Impulse Strength:** The voltage breakdown of insulation under voltage surges on the order of microseconds in duration.

**Impulse Test:** An insulation test in which the voltage applied is an impulse voltage of specified wave shape.

**Incoherent Source:** (fiber optic) A light source which emits wide, diffuse beams of light of many wave lengths.

**Index-Matching Fluid:** (fiber optic) Fluid with refractive index same as fiber core; used to fill air gap between fiber ends at connectors.

**Index of Refraction:** The ratio of light velocity in a vacuum to its velocity in a given transmitting medium.

**Inductance:** The property of a circuit or circuit element that opposes a change in current flow, thus causing current changes to lag behind voltage changes. It is measured in henrys.

**Inductive Coupling:** Crosstalk resulting from the action of the electromagnetic field of one conductor on the other.

**Infrastructure, Telecommunications:** A collection of those telecommunications components, excluding equipment, that together provide the basic support for the distribution of all information within a building or campus.

**Insertion Loss:** As measure of the attenuation of a device by determining the output of a system before and after the device is inserted into the system.

**Insertion Tool:** A small, hand-held tool used to insert contacts into a connector.

**Insulated Wire:** A conductor of electricity covered with a non-conducting material.

**Insulating Joint:** A device which mechanically couples and electrically insulates the sheath and armor of contiguous lengths of cable.

**Insulation:** A material having high resistance to the flow of electric current. Often called a dielectric in radio frequency cable.

**Insulation Adhesion:** The degree of tightness of the insulation over the base conductor, measured in terms of force required to remove a specified length of insulation from the wire.

**Insulation Crimp:** The area of a terminal, splice or contact that has been formed around the insulation of the wire.

**Insulation Grip:** Extended cylinders at the rear of crimp-type contacts designed to accept the bared wire and a small length of its insulation.

**Insulation Piercing:** A method of crimping whereby lances cut the insulation of the wires and enter into the strands to make electrical contact.

**Insulation Resistance:** The ratio of the applied voltage to the total current between two electrodes in contact with a specific insulation, usually expressed in meg $\Omega$ -M feet.

**Insulation System:** All of the insulation materials used to insulate a particular electrical or electronic product.

**Integral Belt:** A layer of insulation or semiconductive material applied by extrusion over two or more insulated, twisted or parallel conductors, to form a round, smooth diameter.

**Interconnect:** A connection scheme that provides for the direct connection of individual cables to another cable or to an equipment cable without a patch cord.

**Interconnecting Cable:** The wiring between modules, between units or the larger portions of a system.

**Interconnecting Wire:** The physical wiring between components (outside a module), between modules, between units or between larger portions of a system or systems.

**Interconnection:** Mechanically joining devices together to complete an electrical circuit.

**Interface:** The two surfaces on the contact side of both halves of a multiple-contact connector which face each other when the connector is assembled.

**Intermediate Cross-Connect:** A cross-connect between 1st level and 2nd level backbone cabling.

**Internal Wiring:** Electronic wiring which interconnects components, usually within a sealed subsystem.

**Interstices:** Voids or valleys between individual strands in a conductor or between insulated conductors in a multiconductor cable.

**Ionization Voltage (Corona Level):** The minimum value of falling rms voltage which sustains electrical discharge within the vacuous or gas-filled spaces in the cable construction or insulation.

**Irradiation:** In insulations, the exposure of the material to high energy emissions for the purpose of favorably altering the molecular structure.

**Jack:** A plug-in type terminal widely used in an electronic apparatus for temporary connections.

**Jacket:** An outer protective sheath over primary insulation, braids, shields, cable components or over the cable itself. In fiber optics, a covering, over a fiber, bundle of fibers or cable which protects against the environment.

**JAN Specification:** Joint Army-Navy specification (replaced by current Military Specifications).

**Jumper:** An assembly of twisted pairs without connectors, used to join telecommunications circuits/links at the cross connect.

**Junction:** A point in a circuit where two or more wires are connected.

**Keying:** The mechanical feature of a connector system that guarantees correct orientation of a connection, or prevents the connection to a jack, or to an optical fiber adapter of the same type intended for another purpose.

**Kynar®:** Pennwalt trade name for polyvinylidene fluoride. Typically used as insulation for wire wrap wire.

**Lacing and Harnessing:** A method of grouping wires by securing them in bundles of designated patterns.

**Lacquer:** A liquid resin or compound applied to textile braid to prevent fraying, moisture absorption, etc.

**Laminated Tape:** A tape consisting of two or more layers of different materials bonded together.

**Laser Diode:** (fiber optic) A semiconductor diode that, when pulsed, a laser diode emits coherent light.

**Launch Angle:** (fiber optic) The angle between the radiation vector and the axis of the fiber or fiber bundle.

**Lay:** The length measured along the axis of a wire or cable required for a single strand (in stranded wire) or conductor (in cable) to make one complete turn about the axis of the conductor or cable.

**Layer:** Consecutive turns of a coil lying in a single plane.

**Leaching and Non-Leaching:** In a leaching wire, the plasticizer will migrate when exposed to heat. A non-leaching wire will retain its plasticizer under extreme temperature conditions and remain flexible after baking.

**Lead:** A wire, with or without terminals, that connects two points in a circuit.

**Lead-Cured:** A cable that is cured or vulcanized in a metallic lead mold.

**Lead Dress:** The placement or routing of wire and component leads in an electrical circuit.

**Lead-in:** The conductor or conductors that connect the antenna proper to electronic equipment.

**Leakage Current:** The undesirable flow of current through or over the surface of an insulation.

**Life Cycle:** A test to determine the length of time before failure in a controlled, usually accelerated, environment.

**Light Commercial Building:** A building or portion thereof that is intended for use with one to four (1-4) non-residential exchange access lines per tenant.

**Light-Intensity Ratio:** (fiber optic) Ratio of input light intensity to the output light intensity.

**Light Source:** (fiber optic) An object capable of emitting light. In fiber optics, the light source is normally an LED or a laser.

**Lightguide:** (fiber optic) A flexible bundle of fibers used to transmit light.

**Lightwave Communications:** (fiber optic) Communications using light to carry the information.

**Limits of Error:** The maximum deviation (in degrees of percent) of a thermocouple or thermocouple extension wire from standard emf-temperature to be measured.

**Limpness:** The ability of a cable to lay flat or conform to a surface.

**Line Balance:** The degree to which the conductors of a cable are alike in their electrical characteristics with respect to each other, to other conductors and to ground.

**Line Drop:** A voltage loss occurring between any two points in a transmission line, due to the resonance, reactance or leakage of the line.

**Line Loss:** The total of the various energy losses occurring in a transmission line.

**Line Voltage:** Voltage existing in a cable or circuit.

**Link:** An assembly of telecommunications facilities between two points, not including terminal equipment.

# Glossary

- Listed:** Equipment included in a list published by an organization, acceptable to the authority having jurisdiction, that maintains periodic inspection of production of listed equipment, and whose listing states either that the equipment or material meets appropriate standards or has been tested and found suitable for use in a specified manner.
- Local Area Network (LAN):** A geographically limited communications network intended for the local transport of data, video and voice.
- Longitudinal Shield:** A tape shield, flat or corrugated, applied longitudinally with the axis of the core being shielded.
- Longitudinal Wrap:** Tape applied longitudinally with the axis of the core being covered.
- Loop Resistance:** The total resistance of two conductors measured round-trip from one end. Commonly used term in the thermocouple industry.
- Looping-in:** Wiring method which avoids tee joints by carrying the conductor or cable to and from the point to be supplied.
- Loss:** Energy dissipated without accomplishing useful work.
- Loss Factor:** The product of the dissipation and dielectric constant of an insulating material.
- Lossy Line:** A cable having large attenuation per unit of length.
- Low-Loss Dielectric:** An insulating material that has a relatively low dielectric loss, such as polyethylene or Teflon®.
- Low-Noise Cable:** Cable configuration specially constructed to eliminate spurious electrical disturbances caused by capacitance changes or self-generated noise induced by either physical abuse or adjacent circuitry.
- Low Tension:** Low voltage, as applied to ignition cable.
- Lug:** Termination, usually crimped or soldered to the conductor, with provision for screwing on to the terminal.
- m:** Meter.
- Magnet Wire:** Insulated wire intended for use in windings on motor, transformer and other coils for electromagnet devices.
- Magnetic Field:** The region within which a body or current experiences magnetic force.
- Magnetic Flux:** The rate of flow of magnetic energy across or through a surface (real or imaginary).
- Magnetic Noise:** Caused by change in current level, e.g. ac powerline (creates magnetic field around the cable) this magnetic field causes the magnetic noise.
- Main Cross-Connect:** A cross-connect for 1st level backbone cables, entrance cables and equipment cables.
- Marker Tape:** A tape laid parallel to the conductors under the sheath in a cable, imprinted with the manufacturer's name and the specification to which the cable is made.
- Master Antenna Television (MATV):** A combination of components providing multiple television receiver operations from one antenna or group of antennas normally on a single building.
- Material Scattering Loss:** (fiber optics) Loss due to fluctuations in the refractive index and to inhomogeneities in material composition and temperature.
- Media, Telecommunications:** Wire, cable or conductors used for telecommunications.
- Megarad:** A unit for measuring radiation dosage.
- Messenger:** Supporting member, usually a high-strength steel wire, used to suspend aerial cable. The messenger may be an integral part of the cable, or exterior to it (lashed messenger).
- Microbending Loss:** (fiber optic) Loss due to small geometrical irregularities along the core-clad interface of the fiber.
- Microfarad:** One-millionth of a farad, commonly abbreviated m-F.
- Micromicrofarad:** One-millionth of a microfarad. (uuf, uufd, mmf, mmfd m-m F are common abbreviations.)
- Microwave:** A short (usually less than 30 cm.) electrical wave.
- Mil:** A unit used in measuring diameter of a wire or thickness of insulation over a conductor. One-one thousandth of an inch (.001").
- Mineral-Insulated:** Cable and thermocouple wire consisting of one or more conductors surrounded by magnesium oxide insulation and enclosed in a liquid- and gas-tight metallic sheathing.
- Miniature Wire:** Insulated conductors of approximately 20-34 AWG.
- Mis-Match:** A termination having a different impedance than that for which a circuit or cable is designed.
- Mode:** One of the components of a general configuration of a propagating wave front.
- Modem:** Device which places and receives data signals over a common carrier's communication facility.
- Modular Jack:** This term is outmoded; see Outlet/Connector, Telecommunications.
- Modular Plug:** A telecommunications connector for wire or cords per the Part 68 Rules. A modular plug can have 6 or 8 contact positions, but not all the positions need be equipped with contacts.
- Modulation:** A process whereby certain characteristics of a wave, often called the carrier, are varied or selected in accordance with a modulating function.
- Modulus of Elasticity:** The ratio of stress to strain in an elastic material.
- Moisture Absorption:** The amount of moisture, in percentage, that a material will absorb under specified conditions.
- Moisture Resistance:** The ability of a material to resist absorbing moisture from the air or when immersed in water.
- Molded Plug:** A connector molded on either end of a cord or cable.
- Monomer:** The basic chemical unit used in building a polymer.
- Motor Lead Wire:** Wire which connects to the fragile magnet wire found in coils, transformers and stator or field windings.
- Multiconductor:** More than one conductor within a single cable complex.
- Multimode Optical Fiber:** An optical fiber that will allow many bound modes to propagate. The fiber may be either a graded-index or step-index fiber. See also: Optical Fiber Cable.
- Multiple Conductor Cable:** A combination of two or more conductors cabled together and insulated from one another and from sheath or armor where used.
- Multiple Conductor Concentric Cable:** An insulated central conductor with one or more tubular stranded conductors laid over it concentrically and insulated from one another.
- Multiplexing:** Simultaneous transmission of two or more messages over the same cable pair.
- Mutual Capacitance:** Capacitance between two conductors when all other conductors are connected together to shield and ground.
- Mylar®:** DuPont trademark for polyester film.
- Nanometer (nm):** One billionth of a meter ( $10^{-9}$  meter).
- Nanosecond:** One billionth of a second ( $10^{-9}$  seconds).
- National Electric Code (NEC):** A set of regulations governing construction and installation of electrical wiring and apparatus in the United States, established by the American National Board of Fire Underwriters.
- Neoprene:** A synthetic rubber with good resistance to oil, chemical and flame. Also called polychloroprene.
- Noise:** In a cable or circuit, any extraneous signal which tends to interfere with the signal normally present in or passing through the system.
- Nomex®:** DuPont trademark for a temperature-resistant, flame-retardant nylon.
- Non-Contaminating:** Type of PVC jacket material whose plasticizer will not migrate into the dielectric of a coaxial cable and thus avoids contaminating and destroying the dielectric.
- Nylon:** Thermoplastic with good chemical and abrasion resistance.
- NVP:** Nominal Velocity of Propagation.
- Off Center:** Conductor displaced within the cross-section of its insulation.
- Offgassing:** Percentage of a specified gas released during the combustion of insulation or jacketing material.
- Ohm:** A unit of electrical resistance.
- Oil Aging:** Cable aged in an accelerated manner by placement in an oil bath and heated to a pre-set temperature for a stated time.
- Oil-Filled Cable:** A self-contained pressure cable in which the pressure medium is low viscosity oil having access to the insulation.
- Opaque:** (fiber optic) Not permitting the passage of light.
- Open Cell:** Foamed or cellular material with cells which are generally interconnected.
- Optical Communication Cable:** (fiber optic) Fiber with a protective jacket around it.
- Optical Conductors:** (fiber optic) Materials which offer a low optical attenuation to transmission of light energy.
- Optical Fiber Cable:** An assembly consisting of one or more optical fibers.
- Optical Fiber Duplex Adapter:** A mechanical media termination device designed to align and join two duplex connectors.
- Optical Fiber Duplex Connector:** A mechanical media termination device designed to transfer optical power between two pairs of optical fibers.
- Optical Waveguide:** (fiber optic) A fiber used for optical communications. Analogous to a waveguide used for microwave communications.
- Oscillatory Surge:** A surge which includes both positive and negative polarity values.
- Outgassing:** The dissipation of gas from a dielectric evidencing decomposition.
- Outlet Box, Telecommunications:** A metallic or nonmetallic box mounted within a wall, floor or ceiling and used to hold telecommunications outlet/connectors or transition devices.



# Glossary

**Outlet/Connector, Telecommunications:** A connecting device in the work area on which horizontal cable terminates.

**Overall Diameter:** Finished diameter over wire or cable.

**Overcoat Conductor:** A stranded conductor made from individual strands of tin-coated wire stranded together, and then given an overall tin coat.

**Overlap:** The amount the trailing edge laps over the leading edge of a spiral tape wrap.

**Oxygen Index:** Percentage of oxygen necessary to support combustion in a gas mixture.

**Ozone:** Reactive form of oxygen, typically found around electrical discharges and present in the atmosphere in small quantities.

**Packing Fraction:** (fiber optic) The ratio of active cross-sectional area of fiber core, or cores, to the total end surface of the fiber, or fiber bundle.

**Pair:** Two insulated wires of a single circuit associated together, also known as a "balance" transmission line.

**Parallel Pair:** A duplex construction of two insulated conductors laid parallel and then covered overall with a braid or jacket.

**Parallel Stripe:** A stripe applied longitudinally on a wire or cable parallel to the axis of the conductor.

**Patch Cord:** A length of cable with connectors on one or both ends used to join telecommunications links/circuits at the cross-connect.

**Patch Cord Cable:** Bulk cable used in the manufacture of patch cords.

**Patch Panel:** A cross-connect system of mateable connectors that facilitates administration.

**Pathway:** A facility for the placement of telecommunications cable. Synonym: Raceway.

**Pay-Off:** The process of feeding a cable or wire from a bobbin, reel or other package.

**Percent Plating:** Quantity of plating on a conductor expressed as a percentage by weight.

**Percentage Conductivity:** Conductivity of a material expressed as a percentage of that of copper.

**Periodicity:** The uniformly spaced variations in the insulation diameter of a transmission cable that result in reflections of a signal, when its wavelength or a multiple thereof is equal to the distance between two diameter variations.

**Permittivity:** See Dielectric Constant.

**Phase:** An angular relationship between waves.

**Phase Shift:** A change in the phase relationship between two alternating quantities.

**Photodetector (Receiver):** Converts light energy to electrical energy.

**Pick:** Distance between two adjacent crossover points of braid filaments. The measurement in picks per inch indicates the degree of coverage.

**Picofarad:** One-millionth of one-millionth of a farad. A micromicrofarad or picofarad (abbreviation pf). (See mm F).

**Pigtail Wire:** Fine-stranded, extra-flexible, rope-lay lead wire attached to a shield for terminating purposes.

**Pitch:** In flat cable, the nominal distance between the index edges of two adjacent conductors.

**Pitch Diameter:** Diameter of a circle passing through the center of the conductors in any layer of a multiconductor cable.

**Plain Conductor:** A conductor consisting of only one metal.

**Plain Weave:** A weave used on woven cables. Threads between the wires act as binders and give the cable lateral stiffness and linear flexibility. Also called Standard and Square Weave.

**Planetary Cabler:** A cabler capable of laying down any number of shielded, overbraided or jacketed singles, pairs, called groups, or any combination of them in sequence.

**Planetary Twister:** A twisting machine whose payoff spools are mounted in rotating cradles that hold the axis of the spool in a fixed direction as the spools are revolved so no twist is built up in each wire.

**Plastic Deformation:** Change in dimensions under load that is not recovered when the load is removed.

**Plasticizer:** A chemical agent added to plastics to make them softer and more pliable.

**Plenum:** The air return path of a central air handling system, either ductwork or open space over a suspended ceiling.

**Plenum Cable:** Cable approved by a recognized agency such as UL for installation in plenums without the need for conduit.

**Plug:** The part of the two mating halves of a connector which is moveable when not fastened to the other mating half.

**Ply:** The number of individual strands or filaments twisted together to form a single thread.

**Point-to-Point:** A type of connection established between two specific locations, as between two buildings.

**Point-to-Point Wiring:** An interconnecting technique wherein the connections between components are made by wires routed between connecting points.

**Polarization:** The orientation of a flat cable or a rectangular connector.

**Polishing:** (fiber optic) Act of smoothing ends of fibers to an 'optically smooth' finish, generally using abrasive.

**Polyester:** Polyethylene terephthalate, used extensively as a moisture-resistant cable core wrap.

**Polyethylene:** A thermoplastic material having excellent electrical properties.

**Polyhalocarbon:** A general name for polymers containing halogen atoms. The halogens are fluorine, chlorine, bromine and iodine.

**Polymer:** A material of high molecular weight formed by the chemical union of monomers.

**Polyolefin:** Any of the polymers and copolymers of the ethylene family of hydrocarbons.

**Polypropylene:** A thermoplastic similar to polyethylene but stiffer and having higher softening point (temperature); excellent electrical properties.

**Polyurethane:** Class of polymers known for good abrasion and solvent resistance (may be applied in solid or cellular form).

**Porosity:** Multiple voids in an insulation cross-section.

**Potting:** The sealing of a cable termination or other component with a liquid which thermosets into an elastomer.

**Power Cables:** Cables of various sizes, construction and insulation, single or multi-conductor designed to distribute primary power to various types of equipment.

**Power Factor:** The ratio of resistance to impedance. The ratio of the actual power of an alternating current to apparent power. Mathematically, the cosine of the angle between the voltage applied and the current resulting.

**Pre-Bond:** Stranded wire which has been fused, topcoat-tinned or overcoat-tinned.

**Prewiring:** Wiring installed

- Before walls are enclosed or finished.
- In anticipation of future use or need.

**Primary:** The transformer winding which receives the energy from a supply circuit.

**Primary Insulation:** The first layer of non-conductive material applied over a conductor, whose prime function is to act as electrical insulation.

**Primary Protection:** The minimum protection required on all exposed facilities to comply with NEC requirements.

**Primary Wiring:** A printed circuit intended to provide point-to-point electrical connections.

**Programming:** Ability to select various circuit patterns by interconnecting appropriate contacts on one side of a connector plug or panel.

**Propagation Delay:** Time delay between input and output of signal.

**Propagation Time:** Time required for a wave to travel between two points on a transmission line.

**Protocol:** A set of rules for communicating.

**Proximity Effect:** Nonuniform current distribution over the cross-section of a conductor caused by the variation of the current in a neighboring conductor.

**Pull Box:** A device to access a raceway used to facilitate placing of wire or cables.

**Pull Cord/Pull Wire:** Cord or wire placed within a raceway and used to pull wire and cable through the raceway.

**Pull Strength:** See Pull Tension.

**Pull Tension:** The maximum pulling force that can be safely applied to a cable without damage.

**Pulling Eye:** A device used to pull cable into or from a duct.

**Pulse:** Energy which changes abruptly from an intensity to another. May be light energy or electrical energy.

**Pulse Cable:** A type of coaxial cable constructed to transmit repeated high-voltage pulses without degradation.

**Polyvinyl Chloride (PVC):** A general-purpose thermoplastic widely used for wire and cable insulations and jackets.

**Quad:** A series of four separately insulated conductors, generally twisted together in pairs. Also, a series-parallel combination of transistors with increased reliability because failure of one transistor will not disable the entire circuit.

**Quadders:** Three-bay machines which can twist four wires together and cable braided and shielded wires with varying lay lengths.

**Raceway:** Any channel designed for holding wires or cables, e.g. conduit, electrical metallic tubing, sleeves, slots, underfloor raceways, cellular floors, surface raceways, lighting fixture raceways, wireways, cable troughs, busways, auxiliary gutters and ventilated flexible cableways. Synonym: Pathway.

**Rack:** See: Cable Rack.

**Radio Frequency:** The frequencies in the electromagnetic spectrum that are used for radio communications.

# Glossary

- Random Winding:** A winding in rotating equipment wherein the wires do not lie in an even pattern.
- Reactance:** The opposition offered to the flow of alternating current by inductance or capacitance of a compound or circuit.
- Red Plaque:** A powdery, brown-red growth found on silvercoated copper conductors and shield braids.
- Redraw:** The consecutive drawing of wire through a series of dies to reach a desired wire size.
- Reducing Joint:** A joint between two lengths of cable where the conductors are not the same size.
- Reel:** A revolvable flanged device made of wood or metal, used for winding flexible metal wire or cable.
- Reflection:** (fiber optic) Change in direction of a light wave or ray.
- Reflection Loss:** The part of a signal which is lost due to reflection of power at a line discontinuity.
- Refraction:** (fiber optic) The bending of lightwaves or rays as they go from one material to another due to the difference in velocities in the materials.
- Reinforced Sheath:** The outermost covering of a cable that has cable sheath constructed in layers with the addition of a reinforcing material, usually a braided fiber, molded in place between layers.
- Remanence:** The magnetic induction that remains in a magnetic circuit after the removal of an applied magnetomotive force.
- Repeater:** A device which consists of a transmitter and a receiver or transmitter, used to regenerate a signal to increase the system transmission length.
- Resistance:** A measure of the difficulty in moving electrical current through a medium when voltage is applied. It is measured in  $\Omega$ .
- Resistive Conductor:** A conductor with high electric resistance.
- Retractile Cord:** A cord having specially treated insulation or jacket so that it will retract.
- Return Wire:** A ground wire or the negative wire in a direct-current circuit.
- Ribbon Cable:** A flat cable of individually insulated conductors lying parallel and held together by means of adhesive or woven textile yarn.
- Ridge Marker:** One or more ridges running laterally along the outer surface of a plastic-insulated wire for purposes of identification.
- Rigid Bay:** Cabling equipment that maintains component sequence, and can produce cables with distinct layers.
- Rigid Coaxial Cable:** Nonflexible coaxial cable, usually a metal tube armored coaxial cable.
- Ring Tongue:** A solderless terminal that connects wire to a stud.
- Ring Out:** Locating or identifying specific conductive paths by passing current through selected conductors.
- Rip-Cord:** 1.) Two or more insulated conductors in a parallel configuration which may be separated to leave the insulation of each conductor intact. 2.) A small filament cord used to rip through the outer cable sheath.
- RoHS (Restriction on Hazardous Substances):** European Union directive that restricts use of heavy metal substances.
- Rope Concentric:** A group of standard conductors assembled in a concentric manner.
- Rope Lay Conductor:** A conductor composed of a central core surrounded by one or more layers of helically laid groups of wires.
- Rope Unilay:** A group of stranded conductors assembled in a unilay manner.
- Round Wire Shields:** Shields constructed from bare, tinned or silver-plated copper wire that include braided, spiral and reverse spiral.
- Routers:** A device that determines how to forward a packet toward its destination, based on tables that indicate the costs, congestion status and other factors associated with possible routes. Also called a level 3 relay or an intermediate system.
- Rubber (Wire Insulation):** Term used to describe wire insulations made of thermosetting elastomers; occurs naturally or may be made synthetically.
- Rulan®:** DuPont's trade name for their flame-retardant polyethylene insulating material.
- Screen:** A shield placed over the entire core.
- Secondary Insulation:** A nonconductive material that protects the conductor against abrasion and provides a second electrical barrier.
- Segmental Conductor:** A stranded conductor consisting of three or more stranded conducting elements, each element having approximately the shape of the sector of a circle, assembled to give a substantially circular cross-section.
- Selenium Cure:** Process used to cure neoprene and rubber jacketed wires and cables.
- Self-Extinguishing:** Characteristic of a material whose flame is extinguished after the igniting flame source is removed.
- Semi-Conducting Jacket:** A jacket having a sufficiently low resistance so that its outer surface can be kept at substantially ground potential.
- Semi-Rigid:** A cable containing a flexible inner core and a relatively inflexible sheathing.
- Semi-Solid:** An insulation cross-section having a partially open space between the conductor and the insulation perimeter.
- Separator:** A layer of insulating material which is placed between a conductor and its dielectric between a cable jacket and the components it covers, or between various components of a multiple-conductor cable.
- Series Circuit:** A circuit in which the components are arranged end to end to form a single path for current.
- Serve:** A filament or group of filaments such as fibers or wires, wound around a central core.
- Servicing:** A wrapping applied over the core of a cable or over a wire.
- Sheath:** See Cable Sheath.
- Shield:** In cables, a metallic layer placed around a conductor or group of conductors to prevent electrostatic or electromagnetic interference between the enclosed wires or external fields.
- Shield Coverage:** Amount of outer cable covered by the shielding material.
- Shield Effectiveness:** The ability of a shield to screen out undesirable signals.
- Shielded Line:** A transmission line whose elements confine propagated radio waves to an essentially finite space inside a tubular conducting surface called the sheath, thus preventing the line from radiating radio waves.
- Shielded-Type Cable:** A cable in which the surface of the insulation is at ground potential.
- Shunt Wire:** A conductor joining two parts of an electric circuit to divert part of the current.
- Signal:** A current used to convey information, either digital, analog, audio or video.
- Silicone:** A material made from silicon and oxygen. Can be in thermosetting elastomer or liquid form. The thermosetting elastomer form is noted for high heat resistance.
- Silicone Treating:** A silicone liquid treatment applied to insulated conductors to allow for easy jacket stripping.
- Sine Wave:** A wave that can be expressed as the sine of a linear function of time, or space or both.
- Single-ended:** Unbalanced, such as grounding one side of a circuit or transmission line.
- Single-Faced Tape:** Fabric tape finished on one side with a rubber or synthetic compound.
- Singlemode Fiber:** A fiber wave guide in which only one mode will propagate. The fiber has a very small core diameter of approximately 8mm. It permits signal transmission at extremely high bandwidths and is generally used with laser diodes.
- Sizing:** Applying a material to a surface to fill pores.
- Skeleton Braid:** Widely separated braid of fiber copper or steel, used to hold core together, for reinforcing jacket or for shielding.
- Skew Rays:** A ray that does not intersect the fiber axis. Generally, a light ray that enters the fiber core at a very high angle.
- Skim Tape:** Filled tape coated on one or both sides with a thin film of uncured rubber or synthetic compound to produce a coating suitable for vulcanization.
- Skin Effect:** The tendency of alternating current, as its frequency increases, to travel only on the surface of a conductor.
- Sleeve:** A braided, knitted or woven tube used over wires or components as insulation tubing. Also called Sleeving.
- Solid Conductor:** A conductor consisting of a single wire.
- Source Coupling Loss:** (fiber optic) Loss of light intensity as light from source passes into fiber.
- Space, Telecommunications:** An area used for housing the installation and termination of telecommunications equipment and cable, e.g. telecommunications closets, work areas and manhole/handholes.
- Span:** (1.) In flat conductors, distance between the reference edge of the first and the last conductor. (2.) In round conductors, distance between centers of the first and last conductors. (3.) In aerial cable, the distance between poles or support clamps.
- Spark Test:** A test designed to locate pin-holes in the insulation of a wire or cable by application of a voltage for a very short period of time while the wire is being drawn through the electrode field.
- Specific Gravity:** The ratio of the density (mass per unit volume) of a material to that of water.
- Spectral Bandwidth:** The difference between wavelengths at which the radiant intensity of illumination is half its peak intensity.
- Spectral Response:** (fiber optic) The response of a detector (or a system) over different wavelengths.
- Spectrum:** Frequencies that exist in a continuous range and have a common characteristic.
- Speed of Light (c):**  $2.998 \times 10^8$  meters per second.
- Spiral Shield:** A metallic shield of fine-stranded wires applied spirally rather than braided.



# Glossary

**Triple Cable:** A cable composed of three insulated single conductors and one bare conductor, all twisted together. It may or may not have a common covering of binding.

**True Concentric:** A cable in which each successive layer has a reversed direction of lay from the preceding layer.

**Trunk Cable:** See Feeder Cable.

**Tubing:** A tube of extruded non-supported plastic material.

**Twin Cable:** A pair of insulated conductors twisted, sheathed or held together mechanically and not identifiable from each other in a common covering.

**Twin Coaxial:** A configuration containing two separate, complete coaxial cables laid parallel or twisted around each other in one complex.

**Twin Line:** A transmission line which has a solid insulating material, in which the two conductors are placed in parallel to each other.

**Twiner:** A device for twisting together two conductors.

**Twisted Pairs:** A cable composed of two small insulated conductors twisted together without a common covering.

**Unbalanced Line:** A transmission line in which voltages on the two conductors are unequal with respect to ground.

**Unidirectional Concentric Stranding:** A stranding where each successive layer has a different lay length, thereby retaining a circular form without migration of strands from one layer to another.

**Unidirectional Stranding:** A term denoting that in a stranded conductor, all layers have the same direction of lay.

**Unilay Strand:** A conductor constructed with a central core surrounded by more than one layer of helically-laid wires, with all layers having a common length and direction of lay.

**Velocity of Propagation (VP):** The speed of an electrical signal down a length of cable compared to speed in free space expressed as a percent. It is the reciprocal of the square root of the dielectric constant of the cable insulation.

**Volt:** A unit of electromotive force.

**Voltage:** The term most often used in place of electromotive force, potential difference or voltage drop to designate the electric pressure that exists between two points and is capable of producing a current when a closed circuit is connected between two points.

**Voltage Drop:** The voltage developed across a component or conductor by the current in the resistance or impedance of the component or conductor.

**Voltage Rating:** The highest voltage that may be continuously applied to a wire in conformance with standards or specifications.

**Voltage Standing Wave Ratio (VSWR):** The ratio of the maximum effective voltage to the minimum effective voltage measured along the length of a mis-matched radio frequency transmission line.

**Volume Resistivity (Specific Insulation Resistance):** The electrical resistance between opposite faces of a 1 cm. cube of insulating material, commonly expressed in  $\Omega$ /centimeter.

**Vulcanization:** A chemical reaction in which the physical properties of an elastomer are changed by reacting it with sulfur or other cross-linking agents.

**Wall Thickness:** The thickness of the applied insulation or jacket.

**Water Absorption:** A test to determine the water absorbed by a material after a given immersion period.

**Waterblocked Cable:** A cable constructed with no internal voids in order to allow no longitudinal water passage under a given pressure.

**Watt:** A unit of electric power.

**Wave Form:** A graphical representation of a varying quantity. Usually, time is represented on the horizontal axis, and the current or voltage value is represented on the vertical axis.

**Wave Length:** The distance, measured in the direction of propagation, of a repetitive electrical pulse or waveform between two successive points that are characterized by the same phase of vibration.

**Wicking:** The longitudinal flow of a liquid in a wire or cable due to capillary action.

**Wire:** A conductor, either bare or insulated.

**Wire and Cable Marker:** Device for identification marking of wire and cable.

**Wire and Cable Tying, Clamping, and Harnessing Devices:** Tying tapes, lacing cords and flexible sleeveings which are used for wire and cable bundling, harnessing and holding. Other devices include plastic ties or clamps, spiral-cut plastic tubing and plastic U-shaped trays or ducts.

**Wire and Lead Cutters:** Tools for cutting that range from plier-type cutters to semiautomatic or fully automatic machines integrated with other wire processing operations such as stripping, forming and terminating.

**Wire Gauge:** A system of numerical designation of wire sizes.

**Wire Nut:** A closed-end splice that is screwed on instead of crimped.

**Wire Wrapped Connection:** A solderless connection made by wrapping bare wire around a square or rectangular terminal with a power or hand tool.

**Wire Wrapping Tools:** Portable electric tools and automatic stationary machines used to make solderless wrapped connections of wires to terminals.

**Wiring Closet:** See Telecommunications Closet.

**Work Area (Work Station):** A building space where the occupants interact with telecommunications terminal equipment.

**Wrapper:** An insulating barrier applied as a sheet or tape wrapped around a coil periphery.

**Yield Strength:** The minimum stress at which a material will start to physically deform without increase in load.

**Zytel®:** DuPont's trade name for nylon resins.

Sections of this glossary are reprinted with permission from December, 1985 Issue of ELECTRONICS copyright 1985. Lake Publishing Corporation, 17730 W. Peterson Rd., Libertyville, IL 60048-0159 USA. Permission to reprint granted to the Prysmian Corporation. No additional reproduction of this wire and cable glossary allowed without written permission.

# Abbreviations & Acronyms

A-D: Analog to digital conversion	CEBEC: Belgium approval agency; Commitee Electrotechnique Belge Service de la Marque	DGM: Data Grade Medium
ac: Alternating current	CEE: European standards agency; International Commission on Rules for the Approval of Electrical Equipment	DISA: Defense Information Systems Agency (formerly DCA)
AC: Armored Cable, NEC Article 333 Cable Designation	CEN: European Committee for Standardization	DISI: Directory Information Services Infrastructure
ACO: Analog Central Office	CENELEC: European Committee for Electrotechnical Standardization	DIST: District
ACR: Attenuation to Crosstalk Ratio	CFC: Communications Flat Cable	DRT: Plastic range and dryer cord (CSA)
ADO: Auxiliary Disconnect Outlet	ckt: Circuit	DTE: Data Terminal Equipment
AER: Aerial	CLT or CLOS: Closet	DVD: Digital Versatile Disc
AF: Audio frequency	CL2: Class 2 Circuit Cable, NEC Article 725 Cable Designation	DW: Distribution Wire
AIA: American Institute of Architects	CL2P: Class 2 Circuit Plenum Cable, NEC Article 725 Cable Designation	E: Symbol for voltage. Usually used to represent direct voltage or the effective (root-mean-square) value of an alternating voltage
ALPETH: An aerial telephone cable having an aluminum shield and polyethylene jacket	CL2R: Class 2 Circuit Riser Cable, NEC Article 725 Cable Designation	EFTS: Electronic funds transfer system
ALS: A type of cable consisting of insulated conductors enclosed in a continuous, closely fitting aluminum tube	CL2X: Class 2 Circuit Limited Use Cable, NEC Article 725 Cable Designation	EIA: Electronic Industries Association
ALVYN: An indoor, riser rated telephone cable having an aluminum shield and vinyl jacket (PVC)	CL3: Class 3 Circuit Cable, NEC Article 725 Cable Designation	EMF: Electromotive Force
AM: Amplitude Modulation	CL3P: Class 3 Circuit Plenum Cable, NEC Article 725 Cable Designation	EMI: Electromagnetic Interference
ANSI: American National Standards Institute	CL3R: Class 3 Circuit Riser Cable, NEC Article 725 Cable Designation	EMT: Electric Metallic Tubing
ARPANET: Advanced Research Projects Agency Network	CL3X: Class 3 Circuit Limited Use Cable, NEC Article 725 Cable Designation	EP: Entrance point
ASCII: American Standard Code for Information Interchange	CM: Communications Cable, NEC Article 800 Cable Designation	EPDM: Ethylene-propylene-diene monomer rubber
ASME: American Society of Mechanical Engineers	CMA: Circular Mil Area	EPOS: Electronic Point-Of-Sale
ASP: A filled, direct burial telephone cable used in areas subject to rodent attack. It consists of a filled cable core, corrugated aluminum shield, corrugated steel tape, flooding compound and polyethylene jacket.	CMP: Communication Cable Plenum, NEC Article 800 Cable Designation	EPR: Ethylene-propylene rubber
ASTA: United Kingdom approval agency	CMR: Communications Cable Riser, NEC Article 800 Cable Designation	ER: Equipment room
ASTM: American Society for Testing and Materials	CMX: Communications Limited Use Cable, NEC Article 800 Cable Designation	ESS: Electronic Switching System
AWG: American Wire Gauge	CO: Central Office	ESTA: Australian approval agency; Electricity Trust of South Australia
AWM: Appliance wiring material	codec: Coder decoder	ETPC: Electrolytic Tough Pitch Copper
B & S Gauge: See American Wire Gauge (AWG)	COE: Central Office Equipment	ETV: Educational Television
B or BUR: Buried	COS: Cooperation for Open Systems	E/W: Equipped With
AWM: Appliance wiring material	COSINE: Cooperation for Open Systems Interconnection Network in Europe	EX or EXT: Extension
BCF: Billion Conductor Feet	COT: Central Office Terminal	EXCH: Exchange
BEF: Building Entrance Facility	CPC: Customer Premises Communication	f: Frequency
BER: Bit Error Rate	CPE: (1) Chlorinated Polyethylene (2) Customer Premises Equipment or Customer Provided Equipment	FAA: Federal Aeronautics Administration
BIC: Building Industry Consultant	CPU: Central Processing Unit	FCC: (1) Federal Communications Commission (2) Flat Conductor Cable, NEC Article 328 Cable Designation
BICSI: Building Industry Consulting Service International	CRT: Cathode Ray Tube	FDDI: Fiber Distributed Data Interface
BISDN: Broadband Integrated Services Digital Network	CSMA/CD: Carrier Sense Multiple Access/ Collision Detection	FDM: Frequency-Division Multiplexing
BTU: British Thermal Unit	CSPE: Chlorosulfonated Polyethylene	FDR: Feeder
CA: Cable	CTR: Certified Test Report	FEP: Fluorinated ethylene propylene
CATV: (1) Community Antenna Television; Cable Access Television (2) CATV Cable, NEC Article 820 Cable Designation	CV: Continuous vulcanization	FEXT: Far End Crosstalk
CATVP: CATV Plenum Cable, NEC Article 820 Cable Designation	D-A: Digital to analog conversion	FI: Approval agency of Finland; Electrical Inspectorate
CATVR: CATV Riser Cable, NEC Article 820 Cable Designation	DAF: Dedicated Access Facility	FIPS PUB: Federal Information Processing Standard Publication
CATVX: CATV Limited Use Cable, NEC Article 820 Cable Designation	dB: Decibel	FM: Frequency modulation
CB: Citizens band	DBS: Direct Broadcast Satellite	FOCIS: Fiber Optic Connector Intermateability Standard
C-C: Conductor to conductor capacitance	dc: Direct current	FOTP: Fiber Optic Test Procedure
CCITT: The International Telegraph and Telephone Consultative Committee	DCE: Data Circuit-Terminating Equipment	FOTS: Fiber Optics Transmission System
CCTV: Closed-circuit television	DCO: Digital Central Office	FPL: Power Limited Fire Protective Signaling Circuit Cable, NEC Article 760 Cable Designation
CDDI: Copper Distributed Data Interface	DCR: Direct Current Resistance	FPLP: Power Limited Fire Protective Signaling Circuit Plenum Cable, NEC Article 760 Cable Designation
CDF: Central Distribution Frame	DD: Distribution Designer or Distribution Device	FPLR: Power Limited Fire Protective Signaling Circuit Riser Cable, NEC Article 760 Cable Designation
CDO: Community Dial Office	DEMARC: Demarcation point	FR-1: A flammability rating established by Underwriter's Laboratories for wires and cables that pass a specially designed vertical flame test
	DEMKO: Approval agency of Denmark	freq: Frequency
		FRICC: Federal Research Internet Coordinating Committee (now FNC)

# Abbreviations & Acronyms

FRPE: Flame Retardant Polyethylene	kHz: Kilohertz	NEXT: Near End Crosstalk
ft: Foot	Kilo: A numerical prefix denoting 1000 (10 <sup>3</sup> )	nf: Nanofarad
FTP: Fire Transfer Protocol	km: Kilometer	NFPA: National Fire Protection Association
ga: Gauge	KTS: Key Telephone Service	NI: Network Interface
gHz: Gigahertz	kV: Kilovolt	NID: Network Interface Device
grd: Ground	kVA: Kilovolt Ampere	NIST: National Institute of Standards and Technology (formerly NBS)
GTO: Gas tube sign and oil-burner ignition cable. 5,000V-15,000V.	kW: Kilowatt	NIU: Network Interface Unit
H: Designation for intensity of magnetic energy	LAN: Local Area Network	nm: Nanometer
hc: Handset combination (single-line telephone)	LASER: Light Amplification by Stimulated Emission of Radiation	NM & NMC: Non Metallic Sheathed Cable, NEC Article 336 Cable Designation
HC: Horizontal cross-connect	LATA: Local Access Transport Area	NPLF: Non Power-Limited Fire Protective Signaling Circuit Cable, NEC Article 760 Cable Designation
hck: Handset combination; key (six-button telephone)	lbf: Pound force	NPLFP: Non Power-Limited Fire Protective Signaling Circuit Plenum Cable, NEC Article 760 Cable Designation
HDPE: High Density Polyethylene	LBO: Line Buildout	NPLFR: Non Power-Limited Fire Protective Signaling Circuit Plenum Cable, NEC Article 760 Cable Designation
HF: High Frequency	LDPE: Low Density Polyethylene	NRZ: Non Return to Zero
hh: Handhole	LEC: Local Exchange Carrier	NRZI: Non Return to Zero Inverted
Hi-Pot: A test designed to determine the highest voltage that can be applied to a conductor without breaking through the insulation.	LED: Light-Emitting Diode	OC: Optical Carrier
HPD: Rubber- and asbestos-insulated heater cord. No braid on individual conductors but with braid overall. Also made with neoprene insulation and no asbestos or PVC/NBC.	LLDPE: Linear Low Density Polyethylene	ODC: Ozone Depleting Chemical
HPN: Two-conductor, neoprene-insulated heater cord. Parallel construction. For use in damp locations.	LOCA: Loss of Coolant Accident	OP: Outside Plant
HSJ: Same as type HS but with #18, #16 and #14 conductors and differing thickness of jacket.	locap: Low-capacitance, low-loss paired cable	OPE: Outside Plant Engineer
HVAC: Heating, ventilation and air conditioning	MAC: Moves, Adds and Changes	OSHA: Occupational Safety and Health Administration
Hz: Hertz	MAP: Manufacturing Automation Protocol	OSI: Open Systems Interconnection
i: Symbol used to designate current	MATV: Master Antenna Television	OVE: Approval agency of West Germany; Oesterreichischer Verband fur Elektrotechnik
IC: Intermediate cross-connect	Mbps: Megabits per second	PABX: Private Automatic Branch Exchange
ICEA: Insulated Cable Engineers Association	MC: (1) main cross-connect (2) Metal Clad Cable, NEC Article 334 Cable Designation	PAM: Pulse Amplitude Modulation
IDC: Insulation Displacement Connector	MCM: One thousand circular mils	PAP: A commonly used term for air core (unfilled) direct burial telephone cable with a corrugated aluminum shield
IEC: International Electrotechnical Commission	MDF: Main Distribution Frame	PBX: Private Branch Exchange
IEEE: Institute of Electrical and Electronics Engineers	MDPE: Medium Density Polyethylene	PC: Personal Computer
IGS: Integrated Gas Spacer Cable, NEC Article 325 Cable Designation	Meg or Mega: A numerical prefix denoting 1,000,000 (10 <sup>6</sup> )	PCB: Printed Circuit Board
IMSA: International Municipal Signal Association	M/G: Motor/Generator Set	P-FEP: Prysmian proprietary dielectric material used in junction with FEP.
in: Inch	MH: Manhole	PCM: Pulse Code Modulation
IRSC: Internet Research Steering Group	Mho: The unit of conductivity. The reciprocal of an ohm.	PCP: A commonly used term for air core (unfilled) direct burial cable with a corrugated copper shield
IRTF: Internet Research Task Force	MHz: Megahertz	PE: Polyethylene
IS: International Standard	MI: Mineral Insulated Cable, NEC Article 330 Cable Designation	pf: Picofarad
ISA: Instrument Society of America	Micro: A numerical prefix denoting one-millionth (10 <sup>6</sup> )	PFA: Polyfluoroalkoxy
ISDN: Integrated Services Digital Network	MIL STD: Military Standard	PIC: A general term for any type of plastic insulated telephone cable
ISO: International Organization for Standardization	MILNET: Military Network	Pico: A numerical prefix denoting one-millionth of one-millionth (10 <sup>-12</sup> )
ISOC: Internet Society	MLT: Multi-Level Threshold	PL: Private Lines
ITCO: Independent Telephone Company	mm: Millimeter	PLSJ: All-rubber, parallel-jacketed, two-conductor, light-duty cord for pendant or portable use in damp locations. 300V.
ITU-T: International Telecommunications Union - Telecommunications Standardization Section	Modem: Modulator demodulator	PLT: (1) Plant (2) Same as PLSJ except thermo-plastic insulation
IW (C): Inside Wiring (cable)	MTT: Main Telephone Terminal	PLTC: Power Limited Tray Cable, NEC Article 725 Cable Designation
J: Joule	MTW: Machine Tool Wire	PM: Phase Modulation
kcmil: One thousand circular mils	MV: Medium Voltage Cable, NEC Article 326 Cable Designation	POI: Point Of Interface
KEMA KEUR: Approval agency of the Netherlands	MW: Radio hookup wire with polyvinyl insulation and plain or nylon jacket or braid, or shield, 1000V	POSJ: All-rubber, parallel, light duty rip-cord for use on lamps and small appliances, 300V, 60°C
kft: An abbreviation for 1000 ft.	N: Newton	
	NAIC: Network Applications and Information Center	
	NASA: National Aeronautics and Space Administration	
	NBR: Natural butadiene-acrylonitrile copolymer rubber	
	NBS: National Bureau of Standards (now NIST)	
	NEC: National Electrical Code	
	NEMA: National Electrical Manufacturers Association	
	NEMKO: Approval agency of Norway	
	NESC: National Electrical Safety Code	

# Abbreviations & Acronyms

- POT: Thermoplastic, parallel, light duty rip-cord. 300V, 60°C to 105°C.
- POTS: Plain Old Telephone Service (colloquial)
- PP: Polypropylene
- PR: Pair
- PTFE: Polytetrafluoroethylene
- PTSS: Passive Transmission Sub-System
- PVC: Polyvinyl Chloride
- PVDF: Polyvinylidene Fluoride
- R: Symbol for resistance
- R-F: Radio-frequency
- RCDD: Registered Communication Distribution Designer
- REA: Rural Electrification Administration
- REP: Repair
- RFQ: Request for Quote
- RG/U: General utility grade military coaxial cable
- RH: Relative humidity
- RJ-45: A specific pin-point assignment for an eight position modular telecommunications connector.
- RMS: (1) rack mount space (2) Root Mean Squares
- RoHS: Restriction on Hazardous Substances
- S: Heavy-duty, rubber-insulated portable cord. Stranded copper conductors with separator and individual rubber insulation. Two or more color-coded conductors cabled with filler, wrapped with separator and rubber jacketed overall, 600 Volts.
- SAE: Society of Automotive Engineers
- SANZ: Standards Association of New Zealand
- SBR: Styrene Butadiene Rubber
- ScTP: Screened Twisted Pair
- SDN: Switched Digital Network
- SE: Service Entrance Cable, NEC Article 338 Cable Designation
- SEMKO: Approval agency for Sweden
- SFTP: Simple File Transfer Protocol
- SI: System Internationale
- SJ: Junior hard-service, rubber-insulated pendant or portable cord. Same construction as type S, but 300V. Jacket thickness different.
- SJO: Same as SJ, but carolprene, oil-resistant compound outer jacket. Can also be made "water-resistant." 300V, 60°C.
- SJT: Junior hard service thermoplastic or rubber-insulated conductors with overall thermoplastic jacket, 300V, 60°C to 105°C.
- SJTO: Same as SJT but oil-resistant thermoplastic outer jacket. 60°C.
- SMTP: Simple Mail Transfer Protocol
- SNA: Systems Network Architecture
- SNM: Shielded Non Metallic Sheathed Cable, NEC Article 337 Cable Designation
- SNMP: Simple Network Management Protocol
- SNR: Signal to Noise Ratio
- SO: Hard-service cord, same construction as type S except oil-resistant carolprene jacket, 600V, 60° to 90°C.
- SONET: Synchronous Optical Network
- SP-1: All rubber, parallel-jacketed, two-conductor light-duty cord for pendant or portable use in damp locations. 300V.
- SP-2: Same as SP-1, but heavier construction, with or without third conductor for grounding purposes. 300V.
- SP-3: Same as SP-23, but heavier construction for refrigerators or room air conditioners. 300V.
- SPC: Stored Program Control
- SPG: Single Point Ground
- SPT-1: Same as SP-1, except all-thermoplastic. 300V. With or without third conductor for grounding.
- SPT-2: Same as SP-2, except all-thermoplastic. 300V. With or without third conductor for grounding.
- SPT-3: Same as SP-3, except all-thermoplastic. 300V. With or without third conductor for grounding.
- SRD: Portable range or dryer cable. Three or four rubber-insulated conductors with rubber or neoprene jacket, flat or round construction. 300V, 60°C.
- SRDT: Same as SRD, except all-thermoplastic with a maximum temperature of 90°C.
- SRL: Structural return loss
- ST: Hard-service cord, jacketed, same as type S except all-plastic construction, 600V, 60°C to 105°C.
- STA: Station
- STO: Same as ST but with oil-resistant thermo-plastic outer jacket. 600V, 60°C.
- STP: Shielded twisted pair
- SV: Vacuum cleaner cord, two or three-conductor, rubber-insulated. Overall rubber jacket. For light-duty in damp locations. 300V, 60°C.
- SVO: Same as SV except carolprene jacket, 300V, 60°C.
- SVT: Same as SV except all-plastic construction. With or without third conductor for grounding purposes only. 300V, 60°C to 90°C.
- SW: Station Wire
- SWB: Switchboard
- SWR: Standing Wave Ratio
- SYS: System
- TC: (1) Power and Control Tray Cable, NEC Article 340 Cable Designation (2) Telecommunications Closet
- TCP: Transmission Control Protocol
- TDM: Time-Division Multiplexing
- TEL: Telephone
- TELCO: Telephone Company
- TERM: Terminal or termination
- TEW: Canadian Standard Association type appliance wires. Solid or stranded single conductor, plastic-insulated, 600V, 105°C.
- TF: Fixture wire, thermoplastic-covered solid or seven strands. 60°C.
- TFE: Tetrafluoroethylene
- TFF: Same as TF but flexible stranding. 60°C.
- THHN: 90°C, 600V nylon jacketed building wire
- THW: Thermoplastic vinyl-insulated building wire. Flame-retardant, moisture- and heat-resistant. 75°C. Dry and wet locations.
- THWN: Same as THW but with nylon jacket overall. 75°C.
- TIA: Telecommunications Industry Association
- TOC: Tin Overcoat
- TP: Transport Protocol
- TP-PMD: Twisted Pair-Physical Medium Dependent
- TPDDI: Twisted Pair Distributed Data Interface
- TSB: Telecommunications System Bulletin
- TT: Telephone Terminal
- TTB: Telephone Terminal Board
- TTY: Text Telephones
- TW: Thermoplastic vinyl-jacketed building wire, moisture-resistant. 60°C.
- UCC: Uniform Code Council
- UF: Thermoplastic underground feeder and branch circuit cable
- UF: Underground Feeder and Branch Circuit Cable, NEC Article 339 Cable Designation
- UG: Underground
- UHF: Ultra High Frequency, 300 to 3,000 MHz
- UL: Underwriter's Laboratories, Inc.
- µm: Micron or micrometer
- UPC: Universal Packaging Code
- UPS: Uninterruptible Power Supply
- USE: Underground Service Entrance Cable, NEC Article 338 Cable Designation
- UTE: Approval agency for France; Union Technique de l'Electricite
- UTP: Unshielded twisted-pair
- V: Volt
- VDE: West Germany approval agency
- VHF: Very High Frequency, 30 to 300 MHz
- VP: Velocity of Propagation
- VSWR: Volume Standing Wave Ratio
- VW-1: A flammability rating established by Underwriters Laboratories for wires and cables that pass a specially designed vertical flame test, (formerly designated FR-1)
- W: Symbol for watt or wattage
- WA: Work area
- WP: Waterproof Outlet
- X: Cross-connect
- XLPE: Crosslinked polyethylene
- Z: Symbol for impedance

# Hook-Up Wire Product Finder

TEMP. °C	VOLTAGE	UL	UL	CSA	MIL	AWG	P/N	STRAND TYPE	PAGE
60	1500*	—	—	—	—	20	C1326	STRANDED	147
60	3000*	—	—	—	—	20	C1319	STRANDED	147
60	5000*	—	—	—	—	18	C1320A	STRANDED	147
60	5000*	—	—	—	—	18	C1321	STRANDED	147
60	10000*	—	—	—	—	18	C1318	STRANDED	147
80/105	300	1007	1569	TR-64	—	24	C2003A	SOLID	143
80/105	300	1007	1569	TR-64	—	24	C2015A	STRANDED	143
80/105	300	1007	1569	TR-64	—	22	C2004A	SOLID	143
80/105	300	1007	1569	TR-64	—	22	C2016A	STRANDED	143
80/105	300	1007	1569	TR-64	—	20	C2028A	SOLID	143
80/105	300	1007	1569	TR-64	—	20	C2040A	STRANDED	143
80/105	300	1007	1569	TR-64	—	18	C2052A	SOLID	143
80/105	300	1007	1569	TR-64	—	18	C2064A	STRANDED	143
80/105	300	1007	1569	TR-64	—	16	C2053A	SOLID	143
80/105	300	1007	1569	TR-64	—	16	C2065A	STRANDED	143
105	600	1015	—	TEW	—	24	C2100A	STRANDED	144
105	600	1015	—	TEW	—	22	C2101A	STRANDED	144
105	600	1015	—	TEW	—	22	C2117A	SOLID	144
105	600	1015	—	TEW	—	20	C2102A	STRANDED	144
105	600	1015	—	TEW	—	20	C2118A	SOLID	144
105	600	1015	—	TEW	—	18	C2103A	STRANDED	144
105	600	1015	—	TEW	—	18	C2119A	SOLID	144
105	600	1015	—	TEW	—	16	C2104A	STRANDED	144
105	600	1015	—	TEW	—	14	C2105A	STRANDED	144
105	600	1015	—	TEW	—	12	C2106A	STRANDED	144
105	600	1015	—	TEW	—	10	C2107A	STRANDED	144

\* For intermittent duty only



# Multi-Conductor Cable Product Finder

NO. COND.	STRAND TYPE	AWG 24		AWG 22		AWG 20		AWG 18		AWG 16		AWG 14		AWG 12		
		P/N	SHIELD PAGE	P/N	SHIELD PAGE	P/N	SHIELD PAGE	P/N	SHIELD PAGE	P/N	SHIELD PAGE	P/N	SHIELD PAGE	P/N	SHIELD PAGE	
2	Solid			C2515A F.....15 C4167A F.....19 C2676A B.....25 E1482S U.....81 E2482S F.....83 E3482S U-P.....85 E3542S F-P.....88 E1000S U.....89, 98 E2000S F.....90, 99 E3000S U-P 86, 100 E2100S F-P . 87, 101		C4311A U.....2		C3110 U-P.....9 C3060 F-P.....18 E2402S U.....81 E1502S U.....81 C4304A U.....82 E2502S F.....83 C4334A F.....84 E3502S U-P.....85		E2404S U.....81 E1512S U.....81 C4321A U.....82 E2522S F.....83 C4344A F.....84 E3512S U-P.....85		E3612S F-P.....88		E2406S U.....81 E1522S U.....81 C4324A U.....82 E2532S F.....83 C4347A F.....84 E3522S U-P.....85		E1532S U.....81 C4327A U.....82 E2542S F.....83 C4348A F.....84 E3532S U-P.....85
	Stranded	C2461A U.....4 C2513A F.....15 C4152A F.....19 C4216A F.....21 C0740A F.....45	C6348A U.....5 C3105 U-P.....8 C3115 U-P.....9 C4100A U.....12 C0431A U.....14 C2514A F.....15 C2516A F.....15 C2518A F.....16 C2520A F.....16  C3158 F-P.....18 C4153A F.....19 C4168A F.....19 C4192A F.....20 C4210A F.....20 C0450A F.....23 C2882A S.....24 C2677A B.....25 C2679A B.....27 C6700A U.....13 C0760A F.....46 E1002S U.....89, 98 E2002S F.....89, 99 E3002S U-P 86, 100 E2102S F-P . 87, 101 C6892A F.....22 C6810A F.....22	C6351A U.....6 C4117A U.....10 C0433A U.....14 C2524A F.....15 C2540A F.....15 C2519A F.....16  C4154A F.....19 C4166A F.....20 C4211A F.....20 C0452A F.....23 C2888A S.....24 C1642A B.....26 C2681A B.....27 C3602 U-R.....29 C1302 B-R.....30 C6717A U.....13 C0780A F.....46 E1022S U.....89, 98 E2022S F.....90, 99 E3022S U-P 86, 100 E2122S F-P . 87, 101 C6866A F.....22 C6811A F.....22	C2830A U.....6 C3102 U-P.....8 C3112 U-P.....9 C4125A U.....10 C4214A U.....10 C0435A U.....14 C2534A F.....15 C2521A F.....16  C3062 F-P.....18 C4155A F.....19 C4197A F.....20 C4212A F.....20 C0454A F.....23 C2892A S.....24 C2686A B.....27 C1202 B-C.....31, 138 C6725A U.....13 C6714A U.....13 E1032S U.....89, 98 E2032S F.....90, 99 E3032S U-P 86, 100 E2202S F-P . 87, 101 C6897A F.....22 C6812A F.....22	C2405A U.....7 C3193 U-P.....8 C3127 U-P.....9 C4135A U.....11 C0437A U.....14 C2536A F.....15 C3169 F-P.....94 C3068 F-P.....18 C4162A F.....19 C4199A F.....20 C4213A F.....20 C0456A F.....23 C2895A S.....24 C2689A B.....27 C1602 B-C.....31, 138 C6735A U.....13 E1042S U.....89, 98 E2042S F.....90, 99 E3042S U-P 86, 100 E2242S F-P . 87, 101 C6899A F.....22 C6813A F.....22	C2409A U.....7 C3126 U-P.....8 C3128 U-P.....9 C4146A U.....11 C0439A U.....14 C2538A F.....15 C4163A F.....19 C4201A F.....20 C4215A F.....20 C0458A F.....23 C6746A U.....13 E1052S U.....89, 98 E2052S F.....90, 99 E3052S U-P 86, 100 E2252S F-P . 87, 101 C6801A F.....22 C6815A F.....22	C2410A U.....7 C3135 U-P.....8 C3129 U-P.....9 C4150A U.....11 C0441A U.....14 C2539A F.....15 C4164A F.....19 C4202A F.....20 C0460A F.....23 E1062S U.....89, 98 E2062S F.....90, 99 E3062S U-P 86, 100 E2262S F-P . 87, 101								
3	Solid							C3114 U-P.....9 E1503S U.....81 C4305A U.....82 E2503S F.....83 C4335A F.....84 E3503S U-P.....85 E3603S F-P.....88		C4322A U.....82 C4345A F.....84		C4325A U.....82				
	Stranded	C2462A U.....4 C4217A F.....21 C0741A F.....45 C0951A FB.....47 C0680A FB.....49	C4062A U.....5 C4101A U.....12 C0432A U.....14 C2526A F.....15 C2517A F.....15  C4156A F.....19 C4169A F.....19 C4193A F.....20 C0451A F.....23 C1335A S.....24 C2678A B.....27 C6701A U.....13 C0761A F.....46 C0971A FB.....48 E1003S U.....89, 98 E2003S F.....90, 99 E3003S U-P 86, 100 E2103S F-P . 87, 101 C6893A F.....22	C6352A U.....6 C4118A U.....10 C0434A U.....14 C2528A F.....15 C2525A F.....15  C4157A F.....19 C4158A F.....19 C4195A F.....20 C0453A F.....23 C1643A B.....26 C1332A B.....27 C3603 U-R.....29 C1304 B-R.....30 C0781A F.....46 E1023S U.....89, 98 E2023S F.....90, 99 E3023S U-P 86, 100 E2123S F-P . 87, 101	C2831A U.....6 C3190 U-P.....8 C3120 U-P.....9 C4126A U.....10 C0436A U.....14 C2535A F.....15  C3064 F-P.....18 C4159A F.....19 C4198A F.....20 C0455A F.....23 C2768A S.....24 C2687A B.....27 C1203 B-C.....31 C6726A U.....13 E1033S U.....89, 98 E2033S F.....90, 99 E3033S U-P 86, 100 E2203S F-P . 87, 101 C6898A F.....22	C2406A U.....7 C3194 U-P.....8 C4136A U.....11 C0438A U.....14  C4200A F.....20 C0457A F.....23 C1603 B-C.....31 C6736A U.....13 E1043S U.....89, 98 E2043S F.....90, 99 E3043S U-P 86, 100 E2243S F-P . 87, 101 C6800A F.....22	C0440A U.....14 C0459A F.....23									

B - Braid Shield  
 C - Carolprene®  
 F - Foil Shield  
 FB - Foil + Braid Shield  
 I - Individual Foil Shield  
 IFB - Individual Foil + Braid Shield  
 P - Plenum  
 R - Rubber  
 S - Spiral Shield  
 U - Unshielded



# Multi-Conductor Cable Product Finder

NO. COND.	STRAND TYPE	AWG 24		AWG 22		AWG 20		AWG 18		AWG 16		AWG 14		AWG 12	
		P/N	SHIELD PAGE	P/N	SHIELD PAGE	P/N	SHIELD PAGE	P/N	SHIELD PAGE	P/N	SHIELD PAGE	P/N	SHIELD PAGE	P/N	SHIELD PAGE
4	Solid			E1484S U .....81 E2484S F ..... 83 E3484S U-P .... 85 E1001S U .....89, 98 E3001S U-P 86, 100				C3111 U-P .....9 C3061 F-P .....18 E1504S U .....81 C4306A U ..... 82 E2504S F ..... 83 C4336A F ..... 84 E3504S U-P .... 85  E3604S F-P ..... 88  C0485 U .....91 C0494 F .....92 C3242 U-P ..... 93 C3170 F-P ..... 94	E1514S U .....81 C4323A U ..... 82 E2524S F ..... 83 C4346A F ..... 84 E3514S U-P ..... 85  E3614S F-P ..... 88  C0486 U .....91 C0495 F .....92 C3243 U-P ..... 93 C3171 F-P ..... 94	E1524S U .....81 C4326A U ..... 82 E2534S F ..... 83 E3524S U-P ..... 85  E3624S F-P ..... 88  C0496 F .....92 C3245 U-P ..... 93 C3173 F-P ..... 94	E1534S U .....81 E2544S F ..... 83 E3534S U-P ..... 85  E3634S F-P ..... 88  C0497 F .....92 C3247 U-P ..... 93 C3175 F-P ..... 94				
	Stranded	C2463A U ..... 4 C4218A F ..... 21 C0742A F ..... 45 C0952A FB ..... 47 C0681A FB ..... 49	C3159 F-P .....18 C4160A F .....19 C4194A F ..... 20 C1337A S ..... 24 C2680A B ..... 27 C6702A U .....13 C0762A F ..... 46 C0972A FB ..... 48 E1004S U .....89, 98 E2004S F .....90, 99 E3004S U-P 86, 100 E2104S F-P . 87, 101 C4063A U .....5 C3106 U-P .....8 C3116 U-P .....9 C4102A U .....12 C2523A F .....15  C6894A F ..... 22	C6353A U .....6 C4119A U .....10 C2555A F .....15  C4161A F .....19 C4196A F .....20 C1644A B ..... 26 C2683A B ..... 27 C3604 U-R ..... 29 C1305 B-R ..... 30 C6718A U .....13 C0782A F ..... 46 E1024S U .....89, 98 E2024S F .....90, 99 E3024S U-P 86, 100 E2124S F-P . 87, 101 C6896A F ..... 22	C2404A U .....6 C3103 U-P .....9 C3113 U-P .....10 C4127A U .....11 C0444A U .....15 C2543A F .....18 C8114 F-P .....19  C3063 F-P ..... 20 C4204A F ..... 22 C2688A B ..... 29 C8110 FB-P .....32  C6727A U .....14 E1034S U ... 91, 100 E2034S F ..... 92, 101 E3034S U-P 88, 102 E2204S F-P 89, 103 C6804A F ..... 24	C2425A U .....7 C3195 U-P .....8 C4137A U ..... 11  C1604 B-C ..... 31 C6737A U .....13 E1044S U .....89, 98 E2044S F .....90, 99 E3044S U-P 86, 100 E2244S F-P. 87, 101 C6837A F ..... 22	C2430A U .....7 C4147A U ..... 11 C6747A U .....13 E1054S U .....89, 98 E2054S F .....90, 99 E3054S U-P 86, 100 E2254S F-P. 87, 101	C2440A U .....7 C4151A U ..... 11 E1064S U .....89, 98 E2064S F .....90, 99 E3064S U-P 86, 100 E2264S F-P. 87, 101							
5	Solid						C3117 U-P .....9 E1505S U .....81 C4307A U ..... 82 C4337A F ..... 84	C4349A U ..... 82 C4350A F ..... 84							
	Stranded	C2464A U ..... 4 C4219A F ..... 21 C0753A F ..... 45 C0953A FB ..... 47 C0682A FB ..... 49	C4064A U .....5 C4103A U .....12 C0973A FB ..... 48  C4207A F ..... 20 C1341A S ..... 24 C6704A U .....13 C0763A F ..... 46 C0974A FB ..... 48 E1006S U .....89, 98 E2006S F .....90, 99 E3006S U-P 86, 100 E2106S F-P . 87, 101 C6807A F ..... 22	C6355A U .....6 C4120A U .....10 C1645A B ..... 26  C1646A B ..... 26 C3606 U-R ..... 29 C1310 B-R ..... 30 C0783A F ..... 46	C2420A U .....6 C3134 U-P .....8 C3125 U-P .....9 C4128A U .....10  C3065 F-P .....18 C4205A F ..... 20 C1206 B-C ..... 31 C6706A U .....13 E1036S U .....89, 98 E2036S F .....90, 99 E3036S U-P 86, 100 E2206S F-P. 87, 101 C6805A F ..... 22	C2434A U .....7 C4138A U ..... 11	C2437A U .....7 C4148A U ..... 11								
6	Solid		E1486S U .....81 C4300A U ..... 82				C3118 U-P .....9 E1506S U .....81 C4308A U ..... 82 E2506S F ..... 83 C4338A F ..... 84 E3506S U-P ..... 85 E3606S F-P ..... 88								
	Stranded	C2466A U ..... 4 C4220A F ..... 21 C0743A F ..... 46 C0954A FB ..... 47 C0683A FB ..... 49	C4066A U .....5 C4104A U .....12  C4207A F ..... 20 C1341A S ..... 24 C6704A U .....13 C0763A F ..... 46 C0974A FB ..... 48 E1006S U .....89, 98 E2006S F .....90, 99 E3006S U-P 86, 100 E2106S F-P . 87, 101 C6807A F ..... 22	C1646A B ..... 26 C3606 U-R ..... 29 C1310 B-R ..... 30 C0783A F ..... 46	C3192 U-P .....8 C3121 U-P .....9 C4206A U .....10  C3065 F-P .....18 C4205A F ..... 20 C1206 B-C ..... 31 C6706A U .....13 E1036S U .....89, 98 E2036S F .....90, 99 E3036S U-P 86, 100 E2206S F-P. 87, 101 C6805A F ..... 22										
7	Solid						C4309A U ..... 82 C4339A F ..... 84								
	Stranded	C2488A U ..... 4 C4221A F ..... 21 C0754A F ..... 45 C0955A FB ..... 47 C0684A FB ..... 49	C4088A U .....5 C4105A U .....12 C0975A FB ..... 48	C6356A U .....6 C4121A U .....10 C3607 U-R ..... 29 C1312 B-R ..... 30	C2421A U .....6 C4129A U .....10  C2426A U .....7 C4139A U ..... 11	C2431A U .....7 C4149A U ..... 11									

B - Braid Shield  
 C - Carolprene®  
 F - Foil Shield  
 FB - Foil + Braid Shield  
 I - Individual Foil Shield  
 IFB - Individual Foil + Braid Shield  
 P - Plenum  
 R - Rubber  
 S - Spiral Shield  
 U - Unshielded



# Multi-Conductor Cable Product Finder

NO. COND.	STRAND TYPE	AWG 24		AWG 22		AWG 20		AWG 18		AWG 16		AWG 14		AWG 12	
		P/N	SHIELD PAGE	P/N	SHIELD PAGE	P/N	SHIELD PAGE	P/N	SHIELD PAGE	P/N	SHIELD PAGE	P/N	SHIELD PAGE	P/N	SHIELD PAGE
8	Solid							C3119 U-P.....9 E1508S U.....81 C4310A U.....82 E2508S F.....83 C4340A F.....84							
	Stranded	C2465A U.....4 C4222A F.....21 C0744A F.....45 C0956A FB.....47 C0685A FB.....49		C4065A U.....5 C4106A U.....12 C4208A F.....20 C0764A F.....46 C0976A FB.....48 E1008S U.....89,98 E2008S F.....90,99 E3008S U-P 86,100 E2108S F-P.. 87,101		C1648A FB.....28 C3608 U-R.....29 C1313 B-R.....30 C0784A F.....46		C3191 U-P.....8 C3122 U-P.....9  E1038S U.....89,98 E2038S F.....90,99 E3038S U-P 86,100 E2208S F-P.. 87,101		C2443A U.....7 C4140A U.....11					
9	Solid							C4312A U.....82 C4341A F.....84							
	Stranded	C2470A U.....4 C4223A F.....21 C0755A F.....45 C0957A FB.....47 C0686A FB.....49		C4070A U.....5 C4107A U.....12 C0977A FB.....48		C6357A U.....6 C4122A U.....10		C2422A U.....6 C4130A U.....10		C2435A U.....7 C4141A U.....11					
10	Solid							C4313A U.....82 C4342A F.....84							
	Stranded	C2471A U.....4 C4224A F.....21 C0745A F.....45 C0958A FB.....47 C0687A FB.....49		C4071A U.....5 C4108A U.....12 C0765A F.....46 C0978A FB.....48 E1010S U.....89,98 E2010S F.....90,99 E3010S U-P 86,100 E2110S F-P.. 87,101		C3610 U-R.....29 C0785A F.....46		C3178 U-P.....8 C3123 U-P.....9  C3183 F-P.....18 E1040S U.....89,98 E2040S F.....90,99							
11	Solid							C4314A U.....82							
12	Stranded	C2467A U.....4		C4067A U.....5 C4109A U.....12 E1012S U.....89,98 E2012S F.....90,99 E3012S U-P 86,100 E2112S F-P.. 87,101		C6360A U.....6 C4123A U.....10		C2412A U.....6 C3179 U-P.....8 C3124 U-P.....9 C4131A U.....10  C3184 F-P.....18 E1041S U.....89,98 E2041S F.....90,99		C2427A U.....7 C4142A U.....11					
15	Solid			C4301A U.....82											
	Stranded	C2473A U.....4 C4225A F.....21 C0746A F.....45 C0959A FB.....47 C0688A FB.....49		C4073A U.....5 C4110A U.....12 C0766A F.....46 C0979A FB.....48 C4111A U.....12		C6358A U.....6 C4124A U.....10 C0786A F.....46		C2423A U.....6 C4132A U.....10		C2428A U.....7 C4143A U.....11					
19	Solid							C2424A U.....6							
	Stranded							C4133A U.....10		C2429A U.....7 C4144A U.....11					
20	Solid			C4302A U.....82				C4316A U.....82							
	Stranded	C4226A F.....21 C0747A F.....45 C0960A FB.....47		C4075A U.....5 C4112A U.....12 C0767A F.....46 C0980A FB.....48											
21	Solid							C4317A U.....82							
25	Stranded	C4227A F.....21 C0748A F.....45 C0961A FB.....47		C4076A U.....5 C4113A U.....12 C0768A F.....46 C0981A FB.....48		C0787A F.....46 C0788A F.....46		C2433A U.....6 C4134A U.....10		C2436A U.....7 C4145A U.....11					
27	Solid														
	Stranded														
30	Solid							C4318A U.....82 C4343A F.....84							
	Stranded	C4228A F.....21 C0749A F.....45		C4077A U.....5 C4114A U.....12											
40	Solid														
	Stranded	C4229A F.....21 C0750A F.....45		C4078A U.....5 C4115A U.....12											
50	Solid														
	Stranded	C4230A F.....21 C0751A F.....45		C4079A U.....5 C4116A U.....12											



B - Braid Shield  
C - Carolprene®  
F - Foil Shield  
FB - Foil + Braid Shield  
I - Individual Foil Shield

IFB - Individual Foil + Braid Shield  
P - Plenum  
R - Rubber  
S - Spiral Shield  
U - Unshielded



# Multi-Conductor Cable Product Finder

NO. PAIR	STRAND TYPE	AWG 28		AWG 24		AWG 22		AWG 20		AWG 18	
		P/N SHIELD	PAGE	P/N SHIELD	PAGE	P/N SHIELD	PAGE	P/N SHIELD	PAGE	P/N SHIELD	PAGE
1	SOLID					C4008A U.....	34				
	STRANDED			C4170A F..... C4209A F..... C4191A F..... C0600A F..... C0841A FB.....	38 38 38 50 53	C7104A F..... C3204 F-P..... C4183A F..... C7112A F..... C0720A F.....	36 37 39 43 50			C6101A U.....	35
2	SOLID					C4010A U..... C1670A F.....	34 36				
	STRANDED			C3150 F-P..... C4171A F..... C0601A F..... C0890A F..... C0620A FB..... C0842A FB..... C0829A FB..... C0515A FB..... C0910A I..... C0924A IFB.....	37 38 50 51 52 53 54 55 57 58	C6010A U..... C3205 F-P..... C4184A F..... C1352A I..... C1353A I..... C4203A I..... C0570A I..... C0550A F..... C7114A F..... C0721A F..... C0650A FB.....	34 37 39 40 40 41 42 43 43 50 52	C7106A I.....	40	C6118A U..... C0584A I..... C0560A F.....	35 42 43
3	SOLID					C4014A U.....	34				
	STRANDED			C3153 F-P..... C4172A F..... C0602A F..... C0901A F..... C0621A FB..... C0843A FB..... C0830A FB..... C0516A FB..... C6065A I..... C0911A I..... C0925A IFB.....	37 38 50 51 52 53 54 55 56 57 58	C6014A U..... C3206 F-P..... C4185A F..... C0571A I..... C0551A F..... C7116A F..... C0722A F..... C0651A FB..... C6040A I.....	34 37 39 42 43 43 50 52 56	C6052A I.....	56	C6103A U..... C0585A I..... C0561A F..... C6047A I.....	35 42 43 56
4	SOLID					C4015A U..... C1676A F.....	34 36				
	STRANDED			C3151 F-P..... C4173A F..... C0603A F..... C0893A F..... C0622A FB..... C0844A FB..... C0831A FB..... C0517A FB..... C0912A I.....	37 38 50 51 52 53 54 55 57	C6015A U..... C3207 F-P..... C4186A F..... C0572A I..... C0552A F..... C0723A F..... C0652A FB.....	34 37 39 42 43 50 52			C6119A U..... C0586A I..... C0562A F.....	35 42 43
4.5	Solid										
	Stranded										
5	Solid									C3120 U.....	9
	Stranded			C4174A F..... C0604A F..... C0894A F..... C0623A FB..... C0832A FB..... C0518A FB.....	38 50 51 52 54 55	C4187A F..... C0724A F..... C0653A FB.....	39 50 52				

B - Braid Shield  
 C - Carolprene®  
 F - Foil Shield  
 FB - Foil + Braid Shield  
 I - Individual Foil Shield  
 IFB - Individual Foil + Braid Shield  
 P - Plenum  
 R - Rubber  
 S - Spiral Shield  
 U - Unshielded



# Multi-Conductor Cable Product Finder

NO. PAIR	STRAND TYPE	AWG 28		AWG 24		AWG 22		AWG 20		AWG 18	
		P/N SHIELD	PAGE	P/N SHIELD	PAGE	P/N SHIELD	PAGE	P/N SHIELD	PAGE	P/N SHIELD	PAGE
6	Solid					C4017A U ..... 34 C1671A F ..... 36					
	Stranded			C3165 F-P ..... 37 C4175A F ..... 38 C0605A F ..... 50 C0899A F ..... 51 C0624A FB ..... 52 C0839A FB ..... 54 C0519A FB ..... 55 C6066A I ..... 56 C0913A I ..... 57		C6017A U ..... 34 C3208 F-P ..... 37  C4188A F ..... 39 C0573A I ..... 42 C0553A F ..... 43 C0725A F ..... 50 C0654A FB ..... 52 C6041A I ..... 56		C6053A I ..... 56		C6106A U ..... 35 C0587A I ..... 42 C0563A F ..... 43 C6048A I ..... 56	
7	Solid										
	Stranded			C4176A F ..... 38 C0606A F ..... 50 C0625A FB ..... 52 C0833A FB ..... 54 C0520A FB ..... 55		C0655A FB ..... 52					
8	Solid										
	Stranded			C4177A F ..... 38 C0607A F ..... 50 C0626A FB ..... 52 C0521A FB ..... 55		C0656A FB ..... 52				C6121A U ..... 35	
9	Solid					C1672A F ..... 36					
	Stranded			C4178A F ..... 38 C0608A F ..... 50 C0896A F ..... 51 C6067A I ..... 56 C0914A I ..... 57		C6019A U ..... 34 C4189A F ..... 39 C0574A I ..... 42 C0554A F ..... 43 C0726A F ..... 50 C6042A I ..... 56		C6054A I ..... 56		C6109A U ..... 35 C0588A I ..... 42 C0564A F ..... 43 C6049A I ..... 56	
10	Solid										
	Stranded			C4179A F ..... 38 C0609A F ..... 50 C0628A FB ..... 52 C0835A FB ..... 54 C0522A FB ..... 55		C0658A FB ..... 52					
11	Solid										
	Stranded			C0915A I ..... 57		C0575A I ..... 42 C0555A F ..... 43 C6043A I ..... 56				C0589A I ..... 42	
12	Solid										
	Stranded			C0836A FB ..... 54 C0916A I ..... 57		C6023A U ..... 34 C6059A I ..... 56		C6056A I ..... 56		C6050A I ..... 56	
12.5	Solid										
	Stranded			C3152 F-P ..... 37 C0897A F ..... 51 C0630A FB ..... 52 C0523A FB ..... 55		C0660A FB ..... 52					
15	Solid					C1673A F ..... 36					
	Stranded			C4180A F ..... 38 C0610A F ..... 50 C0524A FB ..... 55 C0917A I ..... 57		C6026A U ..... 34 C4190A F ..... 39 C0556A F ..... 43 C0728A F ..... 50 C6044A I ..... 56		C6058A I ..... 56		C6111A U ..... 35 C0590A I ..... 42 C0566A F ..... 43 C6051A I ..... 56	

B - Braid Shield  
 C - Carolprene®  
 F - Foil Shield  
 FB - Foil + Braid Shield  
 I - Individual Foil Shield  
 IFB - Individual Foil + Braid Shield  
 P - Plenum  
 R - Rubber  
 S - Spiral Shield  
 U - Unshielded



# Multi-Conductor Cable Product Finder

NO. PAIR	STRAND TYPE	AWG 28		AWG 24		AWG 22		AWG 20		AWG 18	
		P/N SHIELD	PAGE	P/N SHIELD	PAGE	P/N SHIELD	PAGE	P/N SHIELD	PAGE	P/N SHIELD	PAGE
17	Solid										
	Stranded					C6060A I.....	.56				
18	Solid										
	Stranded			C0525A FB.....	.55						
19	Solid										
	Stranded			C4181A F.....	.38	C0729A F.....	.50				
				C0611A F.....	.50	C6045A I.....	.56				
25	Solid										
	Stranded			C4182A F.....	.38	C0663A FB.....	.52				
				C0612A F.....	.50						
				C0526A FB.....	.55						
27	Solid										
	Stranded					C0730A F.....	.50				
						C6046A I.....	.56				
51	Solid										
	Stranded										

B - Braid Shield  
 C - Carolprene®  
 F - Foil Shield  
 FB - Foil + Braid Shield  
 I - Individual Foil Shield  
 IFB - Individual Foil + Braid Shield  
 P - Plenum  
 R - Rubber  
 S - Spiral Shield  
 U - Unshielded







# NEC/CEC Substitution Chart

Communication wire and cable for premise installations in accordance with Article 800, and other applicable parts of the National Electrical Code (NEC), latest issue. Communication wire and cables for Canada are in accordance with the harmonized Canadian Standard Association C22.2 No. 214, Underwriters Laboratories UL 444, latest issue.

**Figure 800-154(E) Cable Substitution Hierarchy**

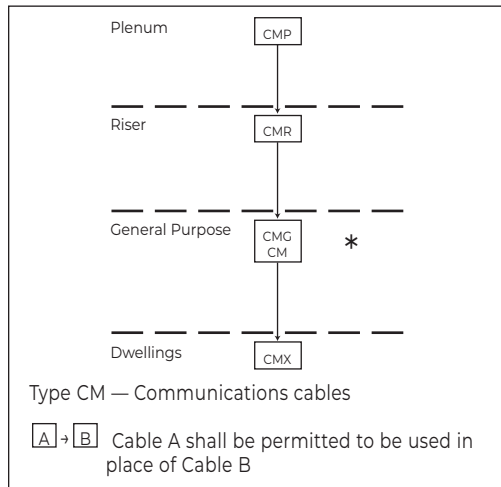

\*CMG can be substituted for CM—CM can NOT be substituted for CMG

**Figure 725-154(G), Cable Substitution Hierarchy**

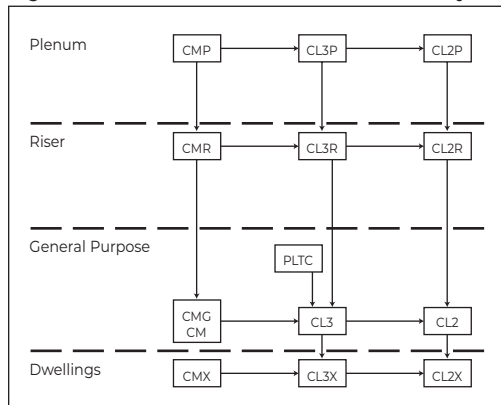

Type CM — Communications wires and cables  
 Type CL2 and CL3 — Class 2 and Class 3 remote-control, signaling and power-limited cables  
 Type PLTC — Power-limited tray cable

A → B Cable A shall be permitted to be used in place of Cable B

FIRE RESISTANCE LEVEL	TEST REQUIREMENT	NEC ARTICLE			
		800	725	760	820
<b>(Highest) Plenum Cables</b>	NFPA 262 (Steiner Tunnel) CSA-CMP (Steiner Tunnel)	CMP	CL3P CL2P	FPLP	CATVP
<b>Riser Cables</b>	UL-1666 (Vertical Shaft)	CMR	CL3R CL2R	FPLR	CATVR
<b>General-Purpose Cables Multiple Floors</b>	UL-1581 (Vertical Tray) CSA-CMG (Vertical Tray)	CMG CM	CL3	FPL	CATV
<b>(Lowest) Residential Cables Restricted Use</b>	UL-1581 VW-1	CMX	CL2 CL3X		CATVX

Notes: 1. Cables with a higher fire resistance level may be substituted for those with a lower fire resistance level.  
 2. Non-fire rated outside plant telephone cables may not run outside of a rigid metal conduit more than 50 feet from the point of entrance into a building.  
 3. Cables rated cmg or cm may be used in runs penetrating one floor. (nec 800-53)

## ARTICLE 800

**Table 800-154(E). Cable Uses and Permitted Substitutions**

CABLE TYPE	USE	REFERENCE	PERMITTED SUBSTITUTIONS
<b>CMP (FT6)</b>	Communications plenum cable	800-154(a)	
<b>CMR</b>	Communications riser cable	800-154(b)	CMP
<b>CMG (FT4) CM (FT1)</b>	Communications general purpose cable	800-154(c)	CMP, CMR
<b>CMX (FT1)</b>	Communications cable, limited use	800-154(c)	CMP, CMR, CMG, CM

Note: See Figure 800-154(E), Cable Substitution Hierarchy

## ARTICLE 725

**Table 725-154(G). Cable Uses and Permitted Substitutions**

CABLE TYPE	USE	REFERENCE	PERMITTED SUBSTITUTIONS
<b>CL3P</b>	Class 3 plenum cable	725-61(a)	CMP
<b>CL2P</b>	Class 2 plenum cable	725-61(b)	CMP, CL3P
<b>CL3R</b>	Class 3 riser cable	725-61(b)	CMP, CL3P, CMR
<b>CL2R</b>	Class 2 riser cable	725-6 (b)	CMP, CL3P, CL2P, CMR, CL3R
<b>PLTC</b>	Power-limited tray cable	725-61(c) and (d)	
<b>CL3</b>	Class 3 cable	725-61(b), (e) and (f)	CMP, CL3P, CMR, CL3R, CMG, CM, PLTC
<b>CL2</b>	Class 2 cable	725-61(b), (c) and (f)	CMP, CL3P, CL2P, CMR, CL3R, CL2R, CMG, CM, PLTC, CL3
<b>CL3X</b>	Class 3 cable, limited use	725-61(b) and (e)	CMP, CL3P, CMR, CL3R, CMG, CM, PLTC, CL3, CMX
<b>CL2X</b>	Class 2 cable, limited use	725-61(b) and (e)	CMP, CL3P, CL2P, CMR, CL3R, CL2R, CMG, CM, PLTC, CL3, CL2, CMX, CL3X

Note: See Figure 725-154(G), Cable Substitution Hierarchy

Reprinted with permission from NFPA 70-2008 National Electrical Code®, copyright © 2008, National Fire Protection Association, Quincy, MA 02269. This reprinted material is not the complete and official position of the NFPA on the referenced subject, which is represented only by the standard in its entirety.

National Electrical Code® and the NEC® are registered trademarks of the NFPA.

# NEC/CEC Substitution Chart

**Figure 760-154 (D), Cable Substitution Hierarchy**

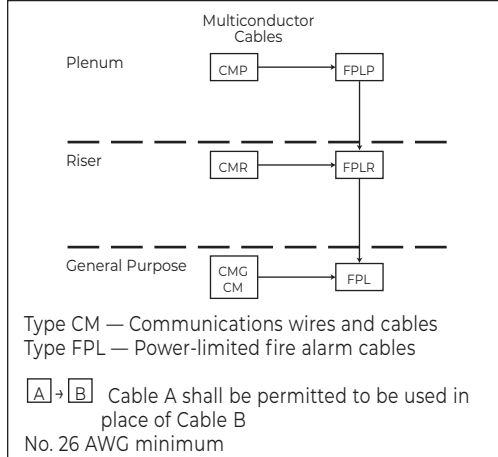

**Article 760**

**Table 760-154 (D). Cable Uses and Permitted Substitutions**

CABLE TYPE	USE	REFERENCES	PERMITTED SUBSTITUTIONS
			MULTICONDUCTOR
<b>FPLP</b>	Power-limited fire alarm plenum cable	760-154 (A)	CMP
<b>FPLR</b>	Power-limited fire alarm riser cable	760-154 (B)	CMP, FPLP, CMR
<b>FPL</b>	Power-limited fire alarm cable	760-154 (C)	CMP, FPLP, CMR, FPLR, CMG, CM

Note: See Figure 760-154 (D), Cable Substitution Hierarchy

**Figure 820-154 (E), Cable Substitution Hierarchy**

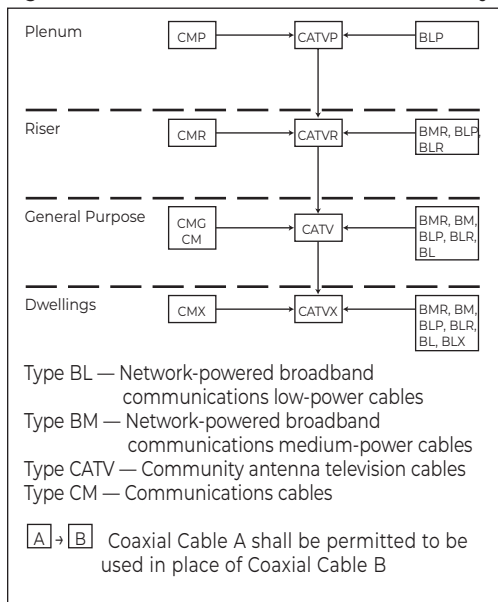

**Article 820**

**Table 820-154 (E). Coaxial Cable Uses and Permitted Substitutions**

CABLE TYPE	USE	REFERENCES	PERMITTED SUBSTITUTIONS
<b>CATVP</b>	Coaxial plenum cable	820-154 (A)	CMP, BLP
<b>CATVR</b>	Coaxial riser cable	820-154 (B)	CATVP, CMP, CMR, BMR, BLP, BLR
<b>CATV</b>	Coaxial general purpose cable	820-154 (C)	CATVP, CMP, CATVR, CMR, CMG, CM, BMR, BM, BLP, BLR, BL
<b>CATVX</b>	Coaxial cable, limited use	820-154 (C)	CATVP, CMP, CATVR, CMR, CATV, CMG, CM, BMR, BM, BLP, BLR, BL, BLX

Note: See Figure 820-154 (E), Cable Substitution Hierarchy

Reprinted with permission from NFPA 70-2002 National Electrical Code®, copyright © 2008, National Fire Protection Association, Quincy, MA 02269. This reprinted material is not the complete and official position of the NFPA on the referenced subject, which is represented only by the standard in its entirety.

National Electrical Code® and the NEC® are registered trademarks of the NFPA.

# Agency Symbols



UL Listed Mark for the United States



CSA CMP



UL Listed Mark for Canada



CSA CMG



UL Listed Mark for Canada and the United States



CSA CMH



UL Recognized Component Mark for the United States



NFPA 262 and CSA FT6 Steiner Tunnel Fire Tests



TIA/EIA 568A Cat. 3

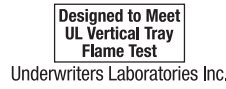

UL Vertical Tray Flame Test



TIA/EIA 568B Cat. 5e & Cat. 6



UL 1666 Riser Flame Test



RoHS Compliant Directive (EU) 2015/863



IMSA



ETL

# Put-Ups and Color Codes

**PUT-UP CODES**

	PULL-PAC®	SPOOL-PAC®	SPOOL	REEL
<b>100'</b>	-	-	12	33
<b>250'</b>	-	-	15	35
<b>500'</b>	25	-	18	38
<b>1000'</b>	30	86	21	41
<b>2000'</b>	-	-	-	43
<b>2500'</b>	-	-	24	44
<b>3000'</b>	-	-	-	52
<b>5000'</b>	-	-	26	46

**JACKET COLOR CODES**

COLOR	ABBREVIATION	COLOR CODE
Black	BK	01
White	WH	02
Red	RD	03
Orange	OR	04
Yellow	YL	05
Green	GN	06
Blue	BL	07
Brown	BR	08
Gray	GY	10
Pink	PK	13
Light Blue	LB	16
Beige	BG	17
Purple	PU	19
Natural	NT	86
Clear	CL	90

Due to variances in monitors and printed materials, the colors above are only a representation of color and do not necessarily reflect the actual jacket color of the cable.