

5-28kV 600/900A Deadbreak



600/900A Deadbreak Elbow



DESCRIPTION

The 600/900 Amp Deadbreak Elbow and accessories offer an easy and reliable method of terminating and splicing main feeder circuits. The Deadbreak Elbow also known as a “T Body”, is a fully shielded, molded EPDM rubber connector utilizing a high-torque, bolted connection making it ideal for highly loaded circuits with high fault currents. Our Deadbreak Elbows are designed for use on solid dielectric cable (XLPE or EPR) with semi-conductive and neutral shielding. The accessory can be installed on cable with or without an outer jacket.

900A RATING

The Deadbreak Elbow can be rated for 900A continuous current when used with a copper top compression connector or shear bolt, copper insulating plug, copper stud, and copper bushing or junction.



INTERCHANGEABILITY

The Deadbreak Elbow has been designed and tested to meet the requirement of IEEE Standard 386, Interface 11. Conformance to this industry standard ensures mechanical and electrical interchangeability with other products of manufacturers that are also in conformance with the standard.



SPECIFICATIONS AND RATINGS:

For Reference, IEEE 386 ratings are provided below.

IEEE 386 – Industry Minimum Requirements	
Voltage Ratings	
Voltage Class, Phase to Phase	25kV
Maximum Operating Voltage – Phase to Ground	16.2kV
Corona Voltage Level – Partial Discharge Extinction Voltage	30kV 
AC Withstand – 1 minute	57kV 
Impulse Withstand Voltage - BIL	125kV
Continuous Current Ratings	
Aluminum Components Utilized	600A
Copper Components Utilized	900A
Short Time Current Ratings	
Aluminum Components Utilized	25kA, 10cycles and 10kA, 3sec.
Copper Components Utilized	40kA, 10cycles and 10kA, 3sec.

 Exceeds IEEE 386 requirement

FEATURES AND BENEFITS

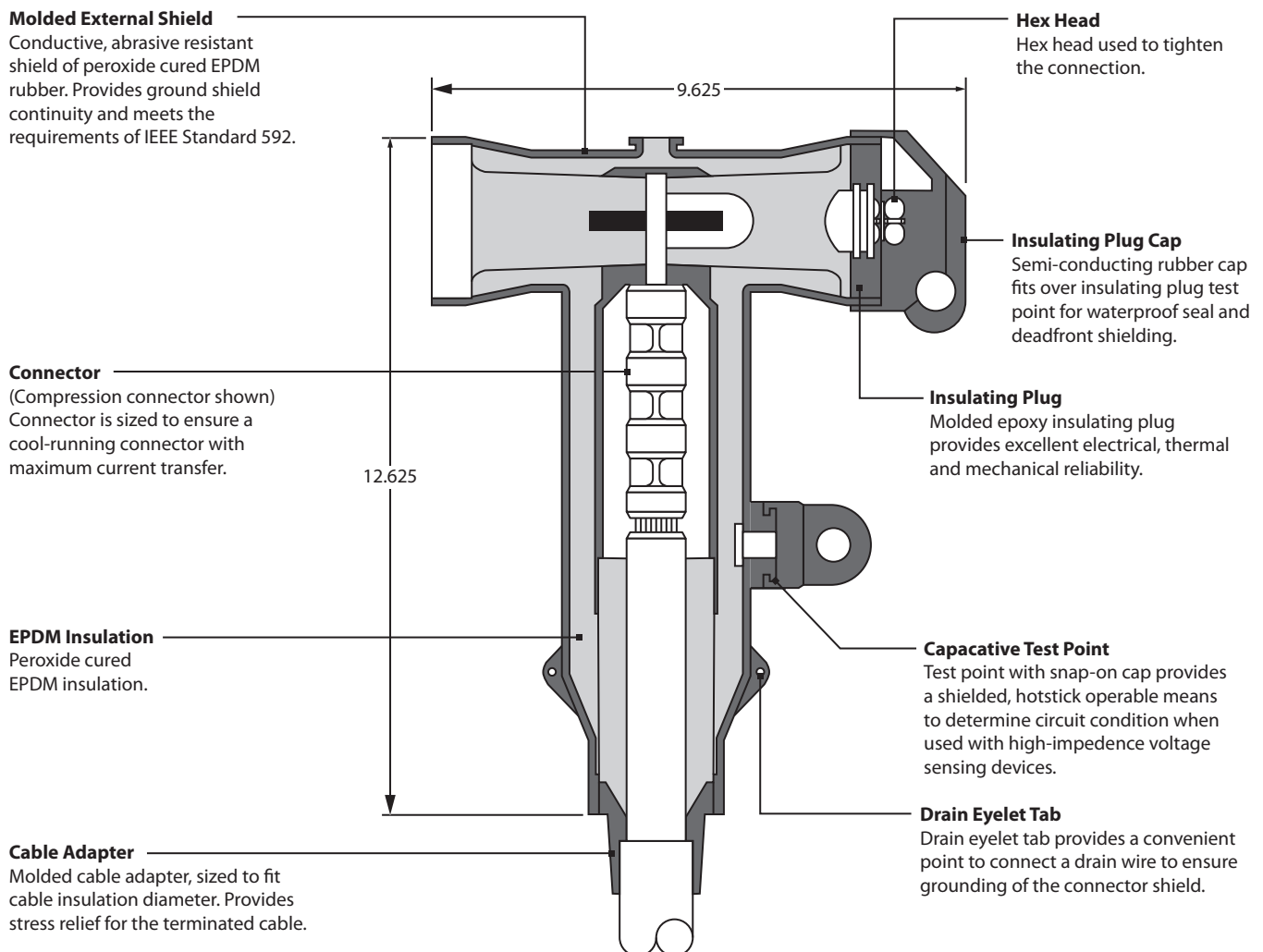

Dimensions are for reference only.

APPLICATIONS

- Outdoor
- Vaults
- Enclosures
- Direct Bury
- Submersible

600/900A Deadbreak Elbow



KIT SELECTION

Use the tables (T#) below to assemble the full catalog ID for the kit needed.

NOTE: Product Series = DBT (Deadbreak T Body with Test Point)

NOTE: Voltage Class = 25 (15/25kV Deadbreak T Body)

EXAMPLE: DBT625K-E-S4100-ALSB1L4-1P

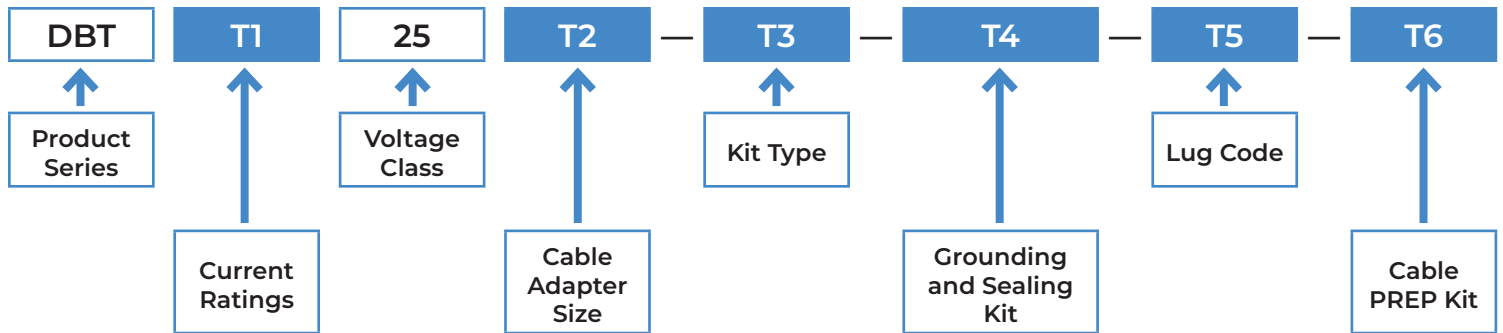

T1 – Current Ratings

Catalog ID	Description
6	600A (Aluminum Components)
9	900A (Copper Components)

T2 – Cable Adapter Size

Catalog ID	Insulation Range INCHES	5kV 100%	5kV 133% 8kV 100%	15kV 100%	15kV 133%	25kV 100%	25kV 133%	28kV 100%
NA	No Adapter	–	–	–	–	–	–	–
E	0.530 - 0.675	1/0-250	1-4/0	4-2/0	4-2	4	–	–
F	0.640 - 0.820	4/0-400	3/0-300	1-4/0	4-2/0	4-1/0	4	4-2
G	0.760 - 0.950	300-550	250-450	3/0-300	1/0-250	2-3/0	4-1	4-2/0
H	0.850 - 1.050	400-650	350-550	250-400	3/0-300	1/0-250	4-2/0	1-4/0
J	0.980 - 1.180	600-800	500-750	350-600	300-500	4/0-400	2/0-250	4/0-350
K	1.090 - 1.310	700-1000	600-900	500-750	400-600	300-500	4/0-350	250-450
L	1.180 - 1.465	900-1000	800-1000	600-900	500-750	400-650	300-500	350-550
M	1.370 - 1.630	1250	1250	900-1000	750-1000	650-900	500-700	600-800
N	1.515 - 1.780	1250-1500	1250-1500	1250	1000-1250	900-1000	700-900	800-1000
P	1.725 - 1.935	–	–	1500	1500	1250-1500	1250	1250-1500

NOTE: Only use Catalog ID = "NA" for the Cable Adapter if you are requesting a Kit Type = O (Deadbreak Housing ONLY). A cable adapter is required to properly install the accessory onto a cable. Cable sizes listed are conservative based on industry standards.

T3 – Kit Type

Catalog ID	Description	T Body	Connecting Plug	Epoxy Plug and Cap	Stud
O	Deadbreak Housing ONLY	1	–	–	–
E	Equipment Connection (For future apparatus bushing)	1	–	1	1
S	Splice (Splice cable using Deadbreak T-body)	1	1	1	1
T	Tap Kit (Add-on, for adding to “S” kits for multi-tap splice or adding another cable to existing installation).	1	1	–	1
D	Dead End Splice (With future add-on capability).	1	–	2	1

Kit Type Configurations

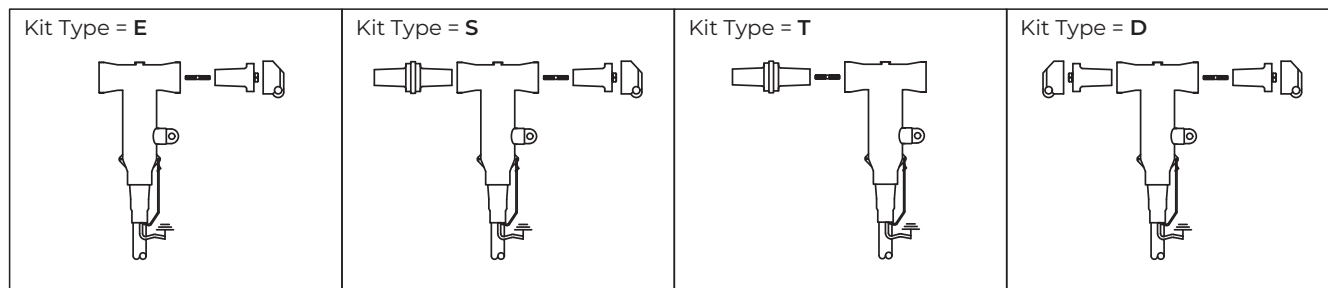

T4 – Grounding and Sealing Kits

Catalog ID	Cable Adapter Sizes	Cold Shrink Tube	#6 Ground Braid with Drain Wire	Constant Force Spring
NG	–	–	–	–
S4000	E – H	1	–	–
S4100	J – P	1	–	–
GS4002	E – H	1	1	1
GS4102	J – K	1	1	1
GS4103	L – M	1	1	1
GS4104	N – P	1	1	1

NOTE: When working with jacketed cable it is recommended to re-seal the bottom of the Deadbreak T body with a sealing kit. Depending on the cable construction and local installation practices, the cable neutrals may also require special treatment. For jacketed cables like tape shielded cable, a ground braid should be used to connect the shield to ground without disturbing the integrity of the seal. If you are unsure if or which kit to include, please contact your Prysmian representative.

NOTE: Grounding and Sealing Kits can be ordered as part of the Deadbreak T Body kit or separately. If you do not want a grounding or sealing kit to be included with the finished kit use “NG” as the catalog ID. Contact your Prysmian representative for details

T5 – Recommended Shear Bolt Lugs

Catalog ID	Connector Type	Cable Size		Conductor Material	Current Rating
		Stranded / Compressed	Compact / Solid		
NC	–	–		–	–
ALSB1L1	Shear Bolt	#5 - 300		Bi-Metallic (AL / CU)	600 / 900
ALSB1L2	Shear Bolt	1/0 - 450		Bi-Metallic (AL / CU)	600 / 900
ALSB1L3	Shear Bolt	3/0 - 600		Bi-Metallic (AL / CU)	600 / 900
ALSB1L4	Shear Bolt	350 - 750		Bi-Metallic (AL / CU)	600 / 900
ALSB1L5	Shear Bolt	600 - 1250		Bi-Metallic (AL / CU)	600 / 900

NOTE: If you need a compression connector, please contact your Prysmian representative and provide the conductor size, material, stranding. This information is critical for selecting an appropriate connector for the application. If you do not want the finished kit to include a lug specify "NC" as the Catalog ID.

T6 – Cable Cleaning “PREP” Kits

Catalog ID	HP Cleaning Pad	Drying Pad	180-Crit AL Oxide Abrasive Cloth
NP	–	–	–
1P	1	1	1

NOTE: Cable preparation and cleaning is critical for the install and operation of any medium voltage accessory. If you do not have access to suitable cleaning supplies, it is recommended a cleaning kit be included. It is critical that cleaning pads are not reused to clean other cables, so consider how many phases you will be preparing with the kit requested when selecting how many cleaning items are needed.

Deadbreak Configurations

NOTE: Below outlines typical configurations found in the industry. Not all possible configurations are outlined. If you require assistance please contact your Prysmian Representative.

TRANSFORMER CONFIGURATIONS:

Kit Type = E

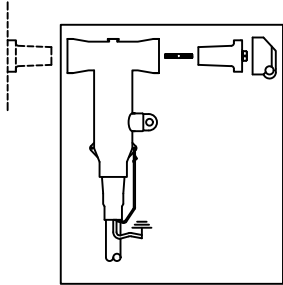

Kit Type = E + Surge Arrester

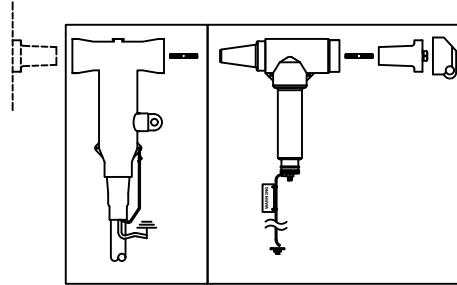

Kit Type = T + E

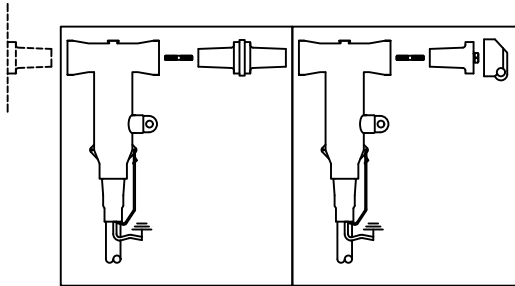

Kit Type = T Kit Type = E
(Add additional T kits if needed)

TRENCH CONFIGURATIONS:

Kit Type = D (Temporary stop)

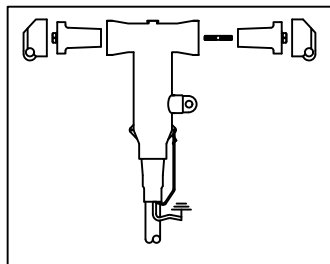

Kit Type = S + T + E (Two or More Deadbreak Splice)

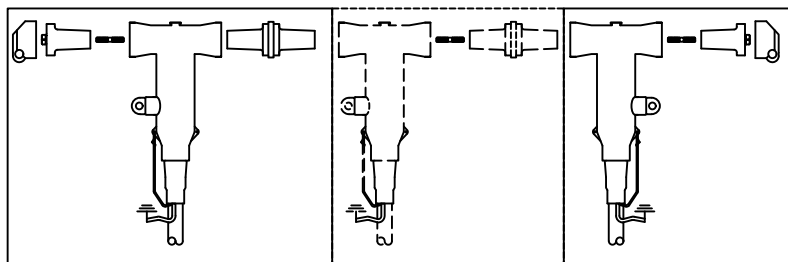

Kit Type = S Kit Type = T (if needed) Kit Type = E



na.prysmian.com

ACS-DS-0023-0526

Follow us

